



Prefabricated Sheet Metal Ducts & Fittings

Indianapolis Division

10401 E. 59th Street • Indianapolis, IN 46236
(800) 490-7707 • (317) 823-5300

PRODUCT NUMBER INDEX

Item No.	Product Name	Page	Item No.	Product Name	Page	Item No.	Product Name	Page
31PF	Plaster Frame	21	1054	Panning Material (17x35)	9	2018	Spin Collar w/Damper Fiberglass	16
37	Rigid S-Cleat (1/2" Leg)	9	1055	Panning Material (32x35)	9	2019	Spin Collar Fiberglass	16
39AL	Aluminum Wall Cap w/Damper	22	1057	Storm Collar	19	2020	Ductboard Collar	16
39GP	Gray Plastic Wall Cap w/Damper	22	1058	Tee Wye	18	2021	Ductboard Collar w/Damper	16
39WP	White Plastic Wall Cap w/Damper	22	1059	Tee Joint 26 Ga.	18	2022	Round to Round Takeoff Fiberglass	15
44S	Damper - Fixed Hardware	19	1059SW	Swivel Tee	18	2023	Spin Collar w/Scoop Fiberglass	16
51F	Straight Ceiling Box w/Flange	21	1060	Free Flow Tee	18	2024	Spin Collar w/Scoop & Damper Fiberglass	16
51P	Straight Ceiling Box w/Plate	20	1061	Y-Branch	18	4005	Aluminum Elbow	22
59F	90° Ceiling Box w/Flange	21	1062	Reducer- 3PC	19	4008	Aluminum Pipe	22
59P	90° Ceiling Box w/Plate	20	1063	Reducer- 2PC	19	AT62	Air-Tite Top Takeoff	17
62	Top Takeoff Metal	14	1064	Tee Cap	19	AT62WD	Air-Tite Top w/Damper	17
62FG	Top Takeoff Fiberglass	14	1065	Drawband- Nuts & Bolts	18	AT63	Air-Tite Side Takeoff	17
63	Side Takeoff Metal	14	1066	One Quad Damper	19	AT63A	Air-Tite Adjustable Takeoff	17
85	Insulated Ceiling Box - Top Outlet	21	1067	Two Quad Damper	19	AT63WD	Air-Tite Side w/Damper	17
85S	Insulated Ceiling Box - Side Outlet	21	1068	Floor Register Box- 5" Deep	21	ATD	Air-Tite Takeoff w/Damper	17
87	Lever Takeoff Metal	14	1069	Floor Register Box- 10" Deep	21	ATDBM	Air-Tite Bellmouth Takeoff w/Damper	17
100	Oval Pipe- 100"	10	1070	Chimney Cap	18	ATDRP	Air-Tite Round Pipe Takeoff w/Damper	17
106	Oval to Round Reverse Boot	10	1070A	Vent Cap	18	ATHE	Air-Tite High Efficiency Takeoff	17
110	Oval Stackhead	10	1071	Roof Flashing	19	ATHEWD	Air-Tite High Efficiency Takeoff w/ Damper	17
113	Flat Oval 45° Angle	10	1071T	Tall Roof Flashing	19	ATS	Air-Tite Takeoff w/Scoop	17
114	Flat Oval 90° Elbow	10	1072	Adjustable Plenum Top	8	ATSD	Air-Tite Takeoff w/Scoop & Damper	17
115	Vertical Oval 45° Angle	11	1073	Adjustable Plenum Panel	8	ATT	Air-Tite Takeoff Plain	17
116	Vertical Oval 90° Elbow	11	1074	'A' Style Plenum	8	ATTBM	Air-Tite Takeoff Bellmouth	17
120SC	Snap Collar Metal	16	1075	'B' Style Plenum	8	ATTRP	Air-Tite Round Pipe Takeoff	17
122SC	Snap Collar Fiberglass	16	1076	Complete Adj. Plenum	8	ATTRP45	Air-Tite 45° Saddle Takeoff	17
124	Oval to Round 90° Boot	11	1100	Stack Straight Collar	13	BP12	Black Pipe- 12"	23
124R	Oval 90° Register Boot	10	1100	Trunk Straight Collar	6	BP24	Black Pipe- 24"	23
127	Oval to Round Straight Boot	11	1101	Trunk Reducer	9	BP36	Black Pipe- 36"	23
127R	Oval Straight Register Boot	10	1101A	Trunk Reducer	9	BP54	Black Tee Joint	23
128	Oval to Oval Reverse Boot	11	1102	Trunk Reducer- Tapered to Side	7	BP55	Black Tee Cap	23
128R	Oval End Register Boot	10	1103	Trunk Reducer- Tapered to Center	7	BP58	Black Reducer- 3PC	23
137	Drain Pan	8	1104	S-Cleat	9	BP90	Black 90° Elbow	23
150	Oval Stackhead w/Collar	10	1104R	Rigid S-Cleat (1" Leg)	9	BP96	Black Drawband	23
160	Oval Pipe- 60"	10	1105	Drive Cleat	9	BP127	Black Oval to Rd Adapter	23
162	Oval Top Takeoff	11	1106	Plaster Round	9	BPC	Black Pipe Collar	23
163	Oval Side Takeoff	11	1109	Trunk Transition Collar	7	BPCHAD	Black Chimney Adapter	23
177	Ceiling Outlet	20	1110	Stack End Cap	13	BPCON	Black Connector	23
177S	Ceiling Side Outlet	20	1110	Trunk End Cap	7	BPTC	Black Trim Collar	23
201VH	Aluminum Wall Cap	22	1111	Return Air Frame	9	CID	Cast Iron Damper	23
201VHWP	White Plastic Wall Cap	22	1112	Plenum Corner	9	EP13	Adjustable Takeoff Metal	15
207	90° Vent Saddle	18	1113	8" Drive Cleat	9	EP15	Round to Round Adjustable Takeoff Metal	14
208	45° Vent Saddle	18	1114	10" Drive Cleat	9	EV141	Eave Vent	22
220EC	Eave Vent with Grille	22	1115	Duct Hanger	9	FR	Filter Rack	9
239	Aluminum Roof Cap with Damper & Screen (4")	22	1137	Register Collar	21	HT15	Half Tab Takeoff Metal	14
240	Aluminum Roof Cap with Damper & Screen (up to 7")	22	1140	Vertical Trunk 90° Elbow	6	MF	Aluminum Flexible Duct	22
241	Aluminum Roof Cap with Damper & Screen (up to 10")	22	1141	Vertical Trunk 45° Angle	6	MR	Mounting Rails	21
355	Oval Straight Register Box	11	1145	Flat Trunk 45° Angle	6	OVP114	Oval Pipe - 114"	10
360	Oval Angle Register Box	11	1146	Flat Trunk 90° Elbow	6	PH3	End Register Boot	5
390WP	White Louver Hood with Tail	22	1147	Trunk Offset Collar	6	PH3L	End Register Boot-Left	5
391WP	Face Only	22	1149	Long Style Flat Collar w/Damper	16	PH3R	End Register Boot-Right	5
924	Wallstack- 24"	12	1150	Long Style Flat Collar	16	PH4	90° Register Boot	5
960	Wallstack- 60"	12	1151	Trunk Volume Damper	7	PH5	90° Basement Head Boot	5
970	Wallstack- 100"	12	1161	Diffuser Outlet w/Flange	20	PH7	Straight Register Boot	5
1005	90° Adjustable Elbow	5	1163	Diffuser Outlet	20	PHEXT	PH Extension 10" Long	13
1006	45° Adjustable Angle	5	1166	Sq. to Rd. w/Flange	20	RV51	Aluminum Roof Cap with Screen (up to 8")	22
100824	Round Pipe-24"	4	1170	Diffuser Tee w/Flange	20	SAL	Aluminum Transition Duct	22
100860	Round Pipe-60"	4	1172	Vertical Draft Vent	19	S5	Pivot Takeoff Metal	15
1008120	Round Pipe-120"	4	1221	Horizontal Draft Vent	19	S75	Drawband- Snappy	18
1019	End Stack Boot	12	1221B	Return Air Package	8	SB30	Return Air Support Box	9
1020	90° Stack Boot	12	1222	Cold Air Boot	8	SB38	Return Air Support Box	9
1024	Straight Stack Boot	12	1222B	Return Air Package	8	SAL	Aluminum Transition Duct	22
1031	Stackhead	13	1223	Cold Air Boot	8	SH	White Flexible Vinyl Hose	22
1031LT	Long Throat Stackhead	13	1223B	Cold Air Boot	8	SPC	Pipe Clamp	22
1031LTWE	Long Throat Stackhead w/Ears	13	1224	Return Air Package	8	SVH	Aluminum Vent Hood	22
1034	Horizontal Stackhead	13	1224B	Cold Air Boot	8	SVHBP	Brown Plastic Vent Hood	22
1040	Vertical Stack 90° Elbow	12	1259	Damper Section	19	SVHWP	White Plastic Vent Hood	22
1041	Vertical Stack 45° Angle	12	1348	Spin Collar w/Damper Metal	16	TD	Trunk Duct	6
1042	Funnel Register Box	20	1349	Spin Collar w/Scoop & Damper Metal	16			
1045	Flat Stack 45° Angle	12	1350	Spin Collar w/Scoop Metal	16			
1046	Flat Stack 90° Elbow	12	1351	Spin Collar Metal	16			
1050	Flat Collar- No Crimp	16	1606	Aluminum Vent Hood	19			
1051	Flat Collar- Crimped	16	1706	Galvanized Vent Hood	19			
1053	Flue Thimble	18	2013	Adj. Takeoff Fiberglass	15			
			2014	Side Takeoff Fiberglass	15			
			2015	Round to Round Takeoff Fiberglass	15			
			2016	Adj. Takeoff Fiberglass	15			

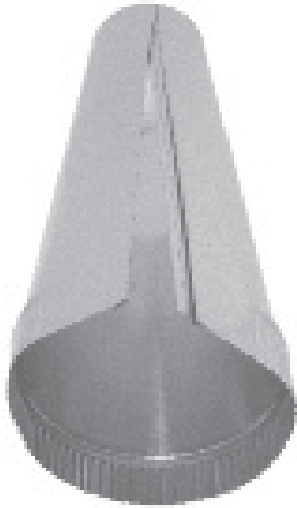

No. 100824
2Ft PIPE - 30, 26 & 24 GAUGE

No tools required to assemble Snaplock Pipe. Simply start at one end and easily snap pipe together. One person can quickly assemble up to 10ft. lengths.

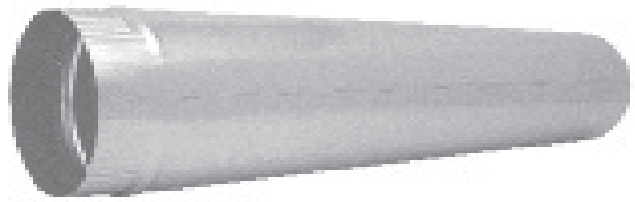

No. 100860
5Ft PIPE - 30 & 26 GAUGE

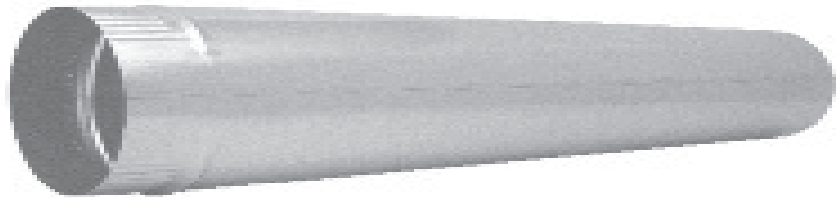

No. 1008120
10Ft PIPE - 30 GAUGE



Self starting crimp is knurled sufficiently so that the crimp "falls in" and yet, once assembled completes a rigid, leak proof connection.



No. 1005
90° ADJUSTABLE ELBOW



No. 1006
45° ADJUSTABLE ANGLE



No. PH4
90° REGISTER BOOT



No. PH7
STRAIGHT
REGISTER BOOT

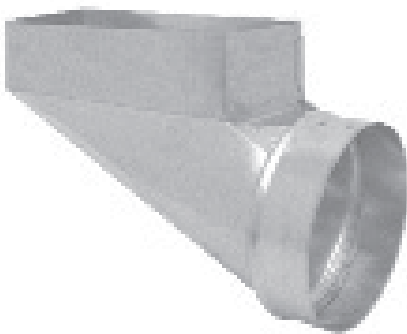

No. PH3
END REGISTER BOOT
No. PH3L LEFT HAND
No. PH3R RIGHT HAND

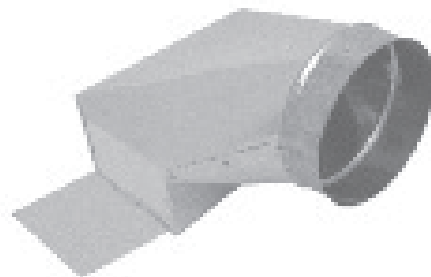

No. PH5
90° BASEMENT BOOT

- 30", 36", 48", 60", and 96" Lengths.
- Furnished in Button Snaplock with S-Cleat & Drive Connections.
- Cross Broken for Extra Stiffening Strength.
- E-Lock Duct available.
- Square Throat Fittings are Standard. Radius available upon request.



No. TD
TRUNK DUCT



No. 1145
FLAT 45° ANGLE

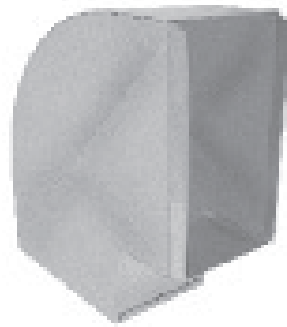

No. 1146
FLAT 90° ELBOW

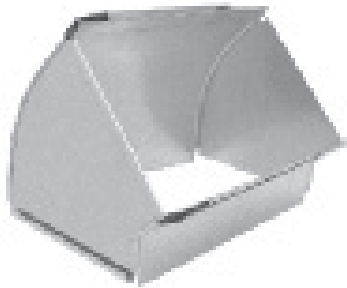

No. 1141
VERTICAL 45° ANGLE

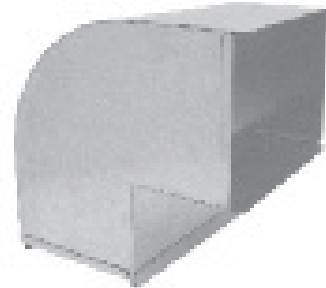

No. 1140
VERTICAL 90° ELBOW

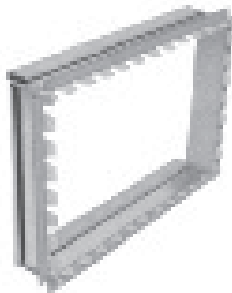

No. 1100
STRAIGHT COLLAR



No. 1147
OFFSET COLLAR

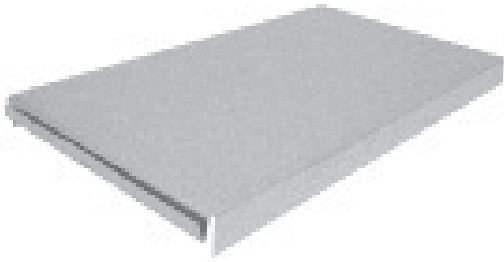

No. 1110
END CAP

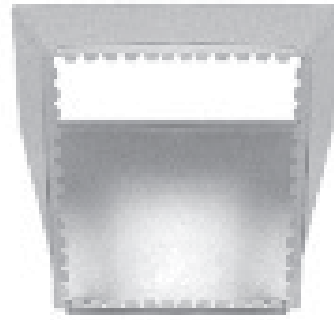

No. 1109
TRANSITION COLLAR

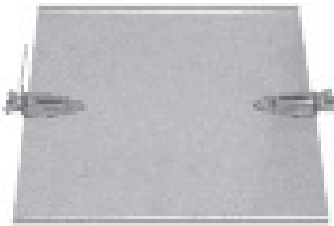

No. 1151
VOLUME DAMPER

1109 TRANSITION COLLAR	
DUCT SIZE	PLENUM OPENING (width x height)
8x8	8x10
10x8	8x10
12x8	10x10
14x8	10x12
16x8	10x12
18x8	10x14
20x8	10x16
22x8	10x18
24x8	10x20
26x8	12x18
28x8	12x18
30x8	12x20
32x8	14x20

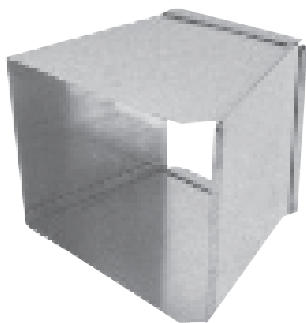

No. 1102
TRUNK REDUCER
TAPERED to ONE SIDE

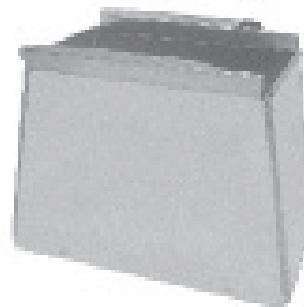

No. 1103
TRUNK REDUCER
TAPERED to CENTER

No. 1072
ADJ. PLENUM TOP



No. 1076
COMPLETE
ADJ. PLENUM

No. 1073
ADJ. PLENUM SIDE



COLD
AIR
BOOT

ADJUSTABLE PLENUMS

AVAILABLE TO ORDER
(Actual plenum height is
2" less than listed size)

TO INSTALL...

- (1) Cut raw edges of side panels to desired width and height sizes.
- (2) Trim top to desired width and depth dimensions.
- (3) Assemble 3 sides, slide top into side panel pockets, then position fourth side.
- (4) Secure assembly with sheet metal screws.



No. 1074
'A' STYLE PLENUM



No. 1075
'B' STYLE PLENUM

RETURN AIR PACKAGE

Complete package
consisting of:

- 1 - Starting Collar
- 2 - 30" Duct Sections
- 1 - R.A. Plenum with
1" Filter Rack
- 6 - 10" Drive Straps

Shipped K.D. in One Carton



No. 137
DRAIN PAN

RA PKG	DUCT SIZE	BOOT ONLY
1221	20 x 10 - 20 x 16	1221B
1222	25 x 10 - 25 x 16	1222B
1223	20 x 10 - 20 x 14	1223B
1224	25 x 10 - 25 x 14	1224B



No. 1113
8" DRIVE CLEAT
No. 1114
10" DRIVE CLEAT



No. 1105
DRIVE CLEAT



No. 1104
S-CLEAT

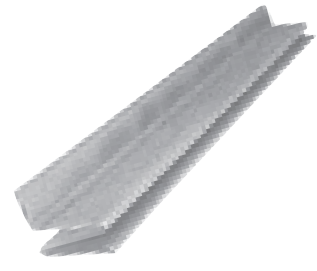

No. 1104R
RIGID S-CLEAT (1" Leg)
No. 37
RIGID S-CLEAT (1/2" Leg)

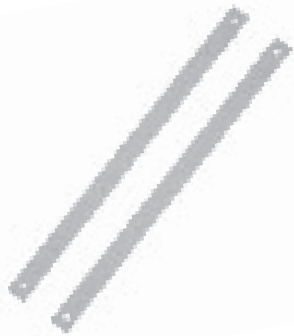

No. 1115
10" DUCT HANGER



No. 1106
PLASTER ROUND



No. 1112
PLENUM
CORNER



No. 1054 (17 x 35)
PANNING MATERIAL
No. 1055 (32 x 35)
PANNING MATERIAL

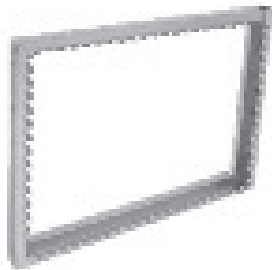

No. FR
FILTER RACK



No. 1111
RETURN AIR
FRAME



No. 1101
TRUNK REDUCER



No. 1101A
TRUNK REDUCER

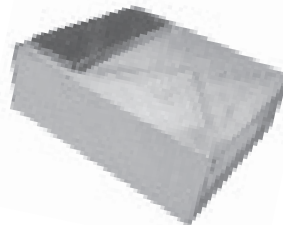

No. SB
RETURN AIR
SUPPORT BOX

RETURN AIR/SUPPORT BOX				
	SB30	SB38	SBF30	SBF36
A DIMENSION	30"	38"	30"	36"
B DIMENSION	20"	26"	22"	26"
RETURN AIR DUCT SIZE	8 x 24	10 x 25	8 x 24	10 x 25



No. SBF
RETURN AIR
SUPPORT BOX
FOR FILTERS

No. 100
OVAL PIPE 100" - 30 Ga.

No. OVP114
OVAL PIPE 114" - 30 Ga.

No. 160
OVAL PIPE 60" - 30 Ga.

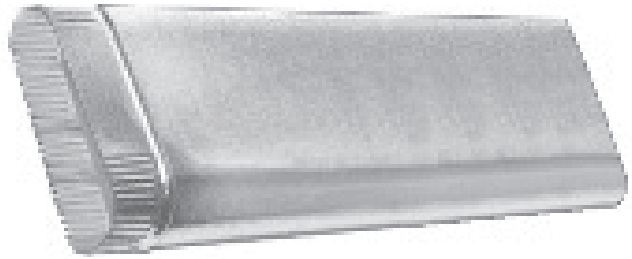

No. 113
FLAT 45° ANGLE



No. 114
FLAT 90° ELBOW



No. 110
OVAL STACKHEAD

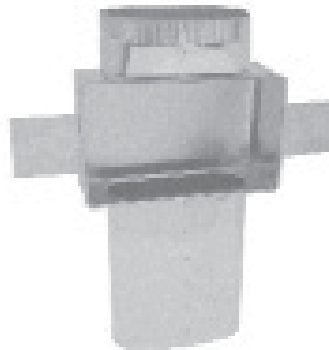

No. 150
STACKHEAD w/COLLAR



No. 106
OVAL to ROUND
REVERSE BOOT



No. 124R
90° REGISTER BOOT



No. 127R
STRAIGHT
REGISTER BOOT

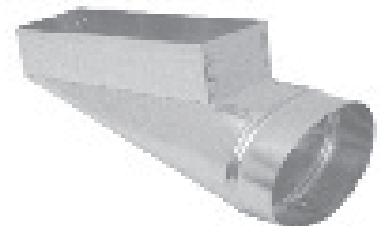

No. 128R
END REGISTER BOOT

WALL STACK vs. OVAL PHYSICAL COMPARISON

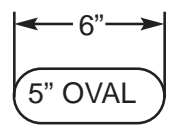
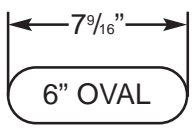
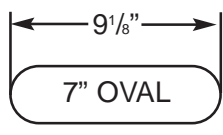
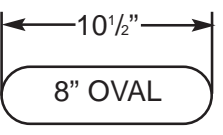
 <p>6"</p> <p>5" OVAL</p> <p>3¼" X 8"</p>	 <p>7⁹/₁₆"</p> <p>6" OVAL</p> <p>3¼" X 10"</p>	 <p>9¹/₈"</p> <p>7" OVAL</p> <p>3¼" X 12"</p>	 <p>10¹/₂"</p> <p>8" OVAL</p> <p>3¼" X 14"</p>
--	---	--	---



No. 115
VERTICAL 45° ANGLE

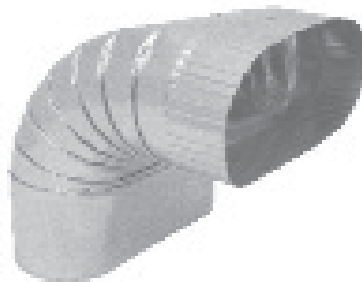

No. 116
VERTICAL 90° ELBOW

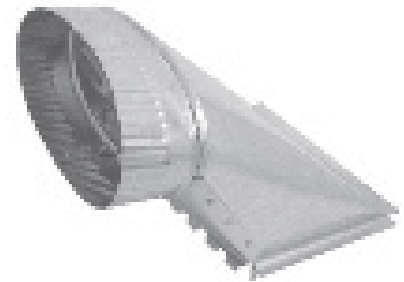

No. 162
OVAL TOP TAKEOFF



No. 127
OVAL to ROUND
STRAIGHT BOOT



No. 124
OVAL to ROUND
90° BOOT



No. 163
OVAL SIDE TAKEOFF



No. 128
OVAL to OVAL
REVERSE BOOT



No. 355
STRAIGHT OVAL
REGISTER BOX

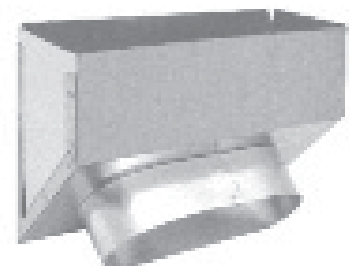

No. 360
ANGLE OVAL
REGISTER BOX

- 24", 60" & 100" Lengths
- Furnished in Button Snaplock.
- Two Pieces Per Section.
- No Tools and No Indentations, Just Snap It and It's Closed.

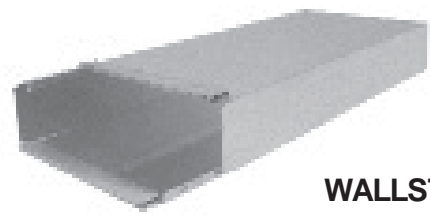

WALLSTACK
No. 924 - 24" Length
No. 960 - 60" Length
No. 970 - 100" Length

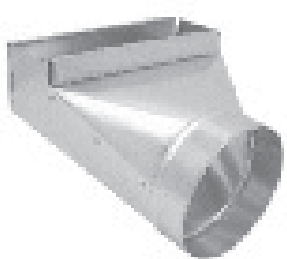

No. 1020
90°
STACK BOOT



No. 1024
STRAIGHT
STACK BOOT

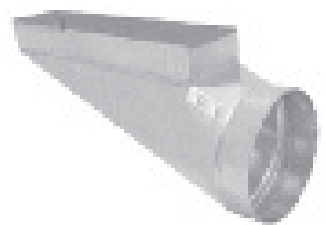

No. 1019
END
STACK BOOT



No. 1045
FLAT 45° ANGLE

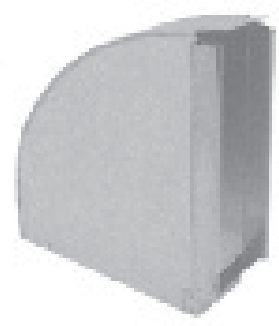

No. 1046
FLAT 90° ELBOW

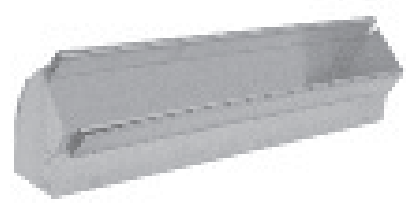

No. 1041
VERTICAL 45° ANGLE

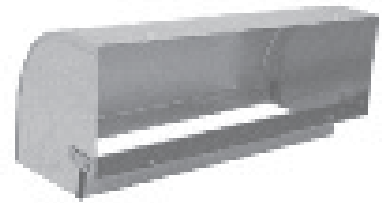

No. 1040
VERTICAL 90° ELBOW

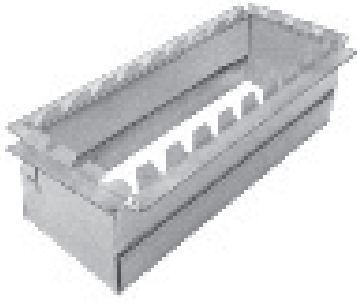

No. 1100
STRAIGHT COLLAR



No. PHEXT
PH EXTENSION
10" LONG



No. 1110
END CAP

STACKHEADS

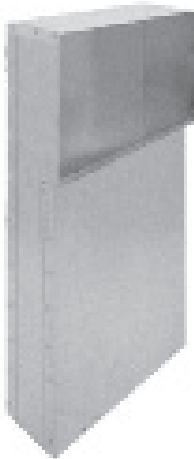

No. 1031LT
LONG THROAT
STACKHEAD

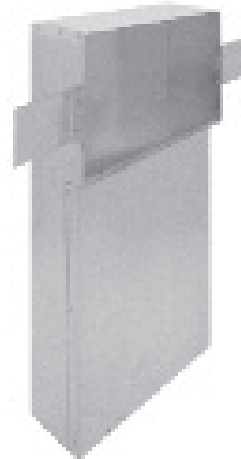

No. 1031LTWE
LONG THROAT
STACKHEAD w/EARS



No. 1031
STACKHEAD

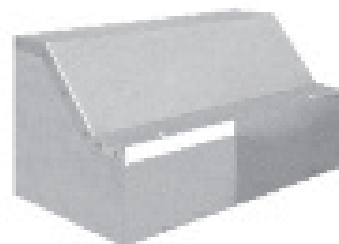

No. 1034
HORIZONTAL
STACKHEAD

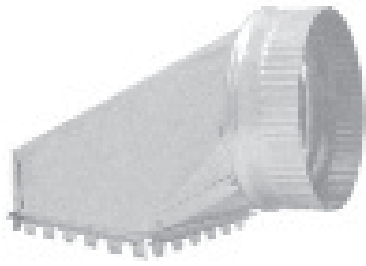

No. 62
SHEET METAL
TOP TAKEOFF

Pipe Size	Base Opening
4"	4 x 6
5"	5 x 6
6"	6 x 6
7"	7 x 7
8"	8 x 8
9"	10 x 10
10"	11½ x 10
12"	12 x 12
14"	14 x 14

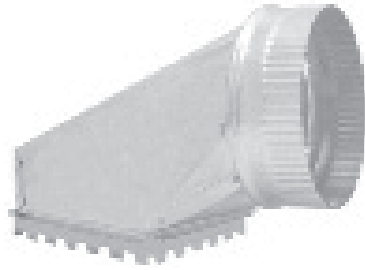

No. 62FG
FIBERGLASS TOP
TAKEOFF

Pipe Size	Base Opening
4"	4 x 6
5"	5 x 6
6"	6 x 6
7"	7 x 7
8"	8 x 8
9"	10 x 10
10"	11½ x 10
12"	12 x 12
14"	14 x 14

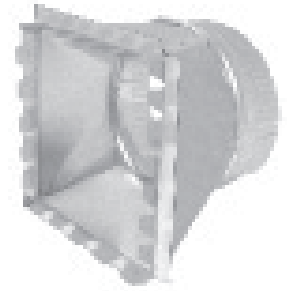

No. 63
SHEET METAL
SIDE RD. TAKEOFF

Pipe Size	Base Opening
4"	6 x 6
5"	6 x 6
6"	6 x 6
7"	6 x 8
8"	6 x 10
9"	7 x 12
10"	7 x 14
12"	8 x 18
14"	8 x 20

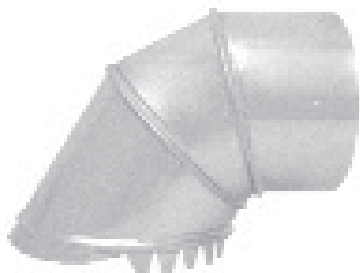

No. HT15
SHEET METAL RD. to RD.
HALF TAB TAKEOFF

Pipe Size	Base Opening
4"	5"
5"	6"
6"	7"
7"	8"



No. EP15
SHEET METAL RD. to RD.
ADJUSTABLE TAKEOFF

Pipe Size	Base Opening
5"	6"
6"	7"
7"	8"
8"	9"



No. 87
SHEET METAL
LEVER TAKEOFF

Pipe Size	Base Opening
5"	6"
6"	7"
7"	8"



No. 2014
FIBERGLASS
SIDE TAKEOFF

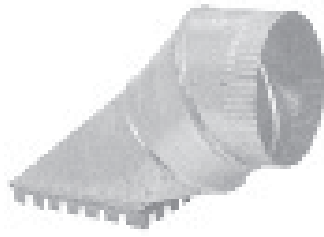

No. EP13
SHEET METAL
ADJ. RD. TAKEOFF



No. 2016
FIBERGLASS
ADJ. TAKEOFF



No. 2013
FIBERGLASS
ADJ. TAKEOFF

Pipe Size	Base Opening
4"	6 x 6
5"	6 x 6
6"	6 x 6
7"	6 x 8
8"	6 x 10
9"	7 x 12
10"	7 x 14
12"	8 x 18
14"	8 x 20

Pipe Size	Base Opening
4"	4 x 6
5"	5 x 6
6"	6 x 7
7"	7 x 8
8"	7 x 10
9"	9 x 11
10"	10 x 12
12"	12 x 16
14"	14 x 19

Pipe Size	Base Opening
4"	4 x 6
5"	5 x 6
6"	6 x 7
7"	7 x 8
8"	7 x 10
9"	9 x 11
10"	10 x 12
12"	12 x 16
14"	14 x 19

Pipe Size	Base Opening
4"	4 x 6
5"	5 x 6
6"	6 x 7
7"	7 x 8
8"	7 x 10
9"	9 x 11
10"	10 x 12
12"	12 x 16
14"	14 x 19



No. S5
SHEET METAL
PIVOT TAKEOFF

Pipe Size	Base Opening
5"	6"
6"	7"
7"	8"



No. 2015
FIBERGLASS
RD. to RD. TAKEOFF

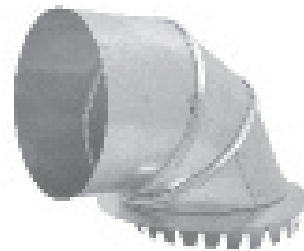

No. 2022
FIBERGLASS
RD. to RD. TAKEOFF

Pipe Size	Base Opening
5"	6"
6"	7"
7"	8"
8"	9"

SHEET METAL COLLARS



No. 120SC
SNAP COLLAR

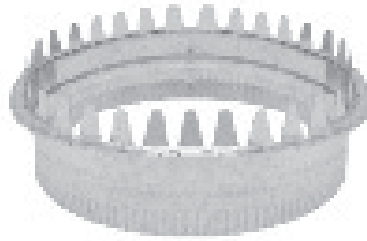

No. 1050
FLAT COLLAR
No. 1051
COLLAR w/CRIMP

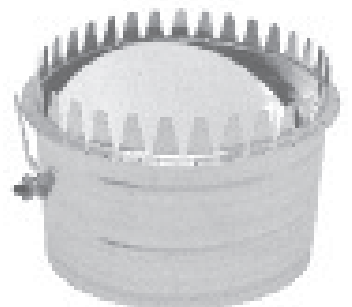

No. 1150
LONG FLAT COLLAR
No. 1149
COLLAR w/DAMPER



No. 1351
SPIN FITTING



No. 1348
SPIN FITTING
w/DAMPER



No. 1350
SPIN FITTING
w/SCOOP

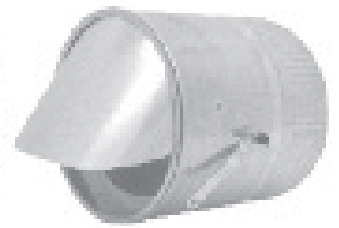

No. 1349
SPIN FITTING
w/SCOOP & DAMPER

FIBERGLASS COLLARS

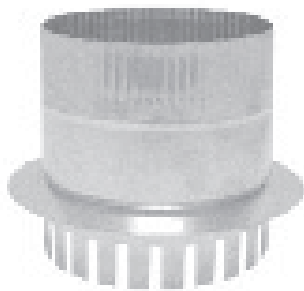

No. 2020
COLLAR
No. 2021
COLLAR w/DAMPER



No. 122SC
SNAP COLLAR



No. 2019
SPIN COLLAR

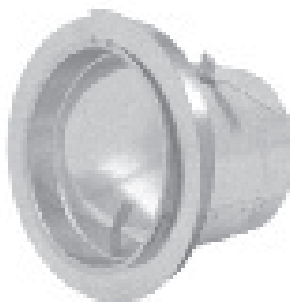

No. 2018
SPIN COLLAR
w/DAMPER

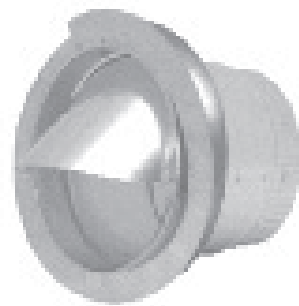

No. 2023
SPIN COLLAR
w/SCOOP

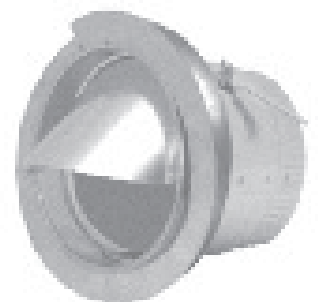

No. 2024
SPIN COLLAR
w/SCOOP & DAMPER



No. ATT
TAKEOFF
PLAIN

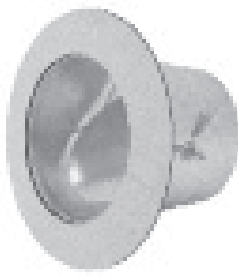

No. ATD
TAKEOFF
w/DAMPER

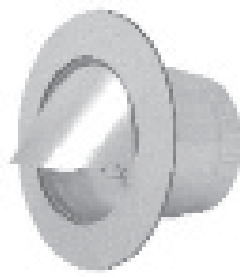

No. ATS
TAKEOFF
w/SCOOP

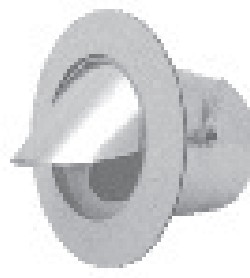

No. ATSD
T.O. w/SCOOP
& DAMPER

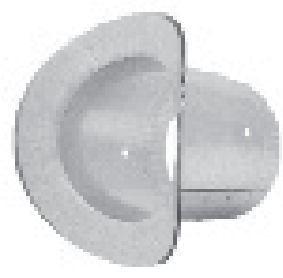

No. ATTRP
RD. PIPE TAKEOFF
No. ATDRP
w/DAMPER

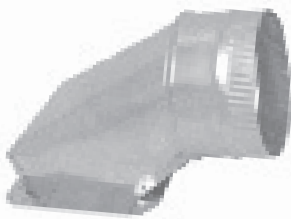

No. AT62
TOP TAKEOFF
No. AT62WD
w/DAMPER

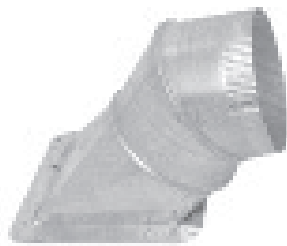

No. AT63A
ADJUSTABLE
RD. TAKEOFF



No. ATTRP45
45° SADDLE



No. ATTBM
BELLMOUTH TAKEOFF
No. ATDBM
w/DAMPER



No. AT63
RECTANGULAR TAKEOFF
No. AT63WD
w/DAMPER



No. ATHE
HIGH EFFICIENCY TAKEOFF
No. ATHEWD
w/DAMPER

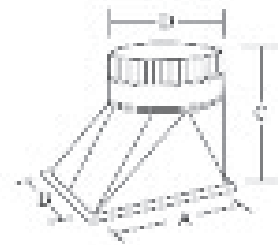

Pipe Size	Base Opening
4"	6 x 6
5"	6 x 6
6"	6 x 6
7"	6 x 8
8"	6 x 10
9"	7 x 12
10"	7 x 14
12"	8 x 18
14"	8 x 20

SIZE	A	B	C	D
5"	10"	6"	10"	5"
6"	10"	6"	10"	6"
7"	10"	6"	10½"	7"
8"	12"	8"	11"	8"
9"	12"	9"	11"	9"
10"	14"	10"	11"	10"
12"	18"	12"	13"	12"
14"	18"	12"	13"	14"

- Tees and Wyes
- Reducers
- Dampers
- Vents
- Drawbands
- Flashings
- Connectors



No. 207
90° VENT SADDLE



No. 208
45° VENT SADDLE

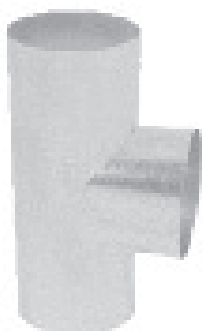

No. 1059
TEE JOINT



No. 1060
FREE FLOW TEE



No. 1058
TEE WYE



No. 1059SW
SWIVEL TEE



No. 1070
CHIMNEY CAP



No. 1070A
VENT CAP



No. 1053
FLUE THIMBLE



No. 1061
Y-BRANCH



No. S75
DRAWBAND

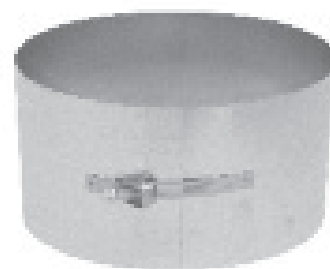

No. 1065
DRAWBAND



No. 1064
TEE CAP
Available Crimped



No. 1062
3 Pc. REDUCER
Available Crimped



No. 1063
2 Pc. REDUCER



No. 1172
HORIZONTAL
DRAFT VENT

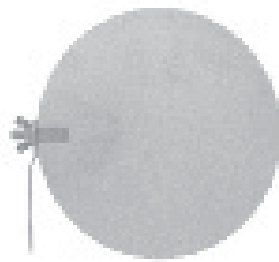

No. 44S
ROUND DAMPER
FIXED HARDWARE

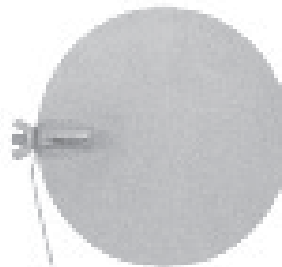

No. 1066
ONE QUAD
DAMPER

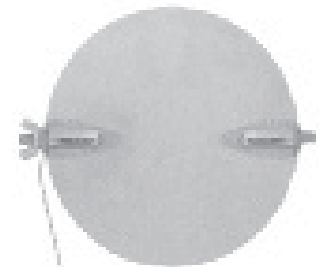

No. 1067
TWO QUAD
DAMPER



No. 1170
VERTICAL
DRAFT VENT



No. 1071
ROOF FLASHING



No. 1071T
TALL FLASHING

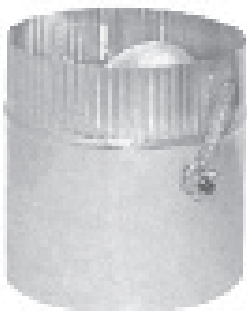

No. 1259
DAMPER SECTION

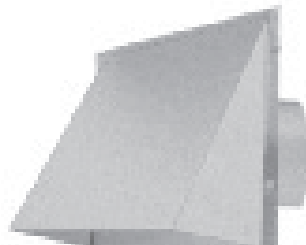

No. 1706
GALVANIZED VENT HOOD
(Available without Damper - No. 1705)

No. 1606
ALUMINUM VENT HOOD
(Available without Damper - No. 1605))

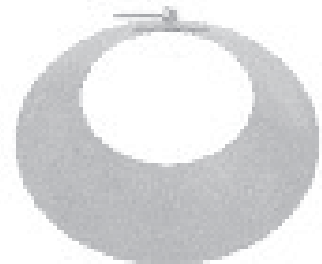

No. 1057
STORM COLLAR



No. 177
CEILING OUTLET

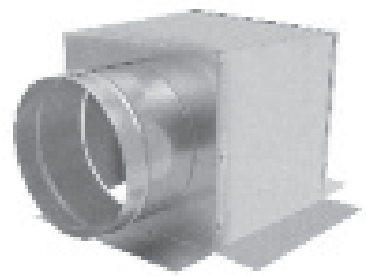

No. 177S
SIDE OUTLET

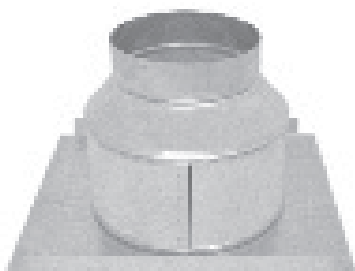

No. 1161
DIFFUSER FUNNEL
w/FLANGE

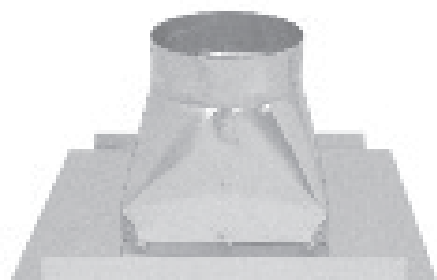

No. 1163
DIFFUSER OUTLET
SQUARE TO ROUND w/FLANGE

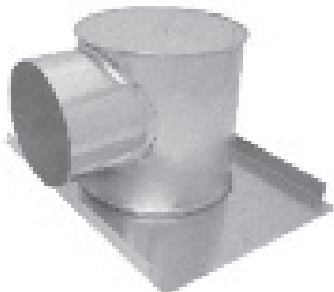

No. 1166
DIFFUSER TEE
w/FLANGE



No. 1042
FUNNEL REGISTER BOX
w/FLANGE

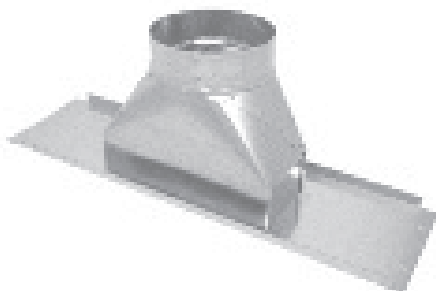

No. 51P
STRAIGHT CEILING BOX
w/PLATE

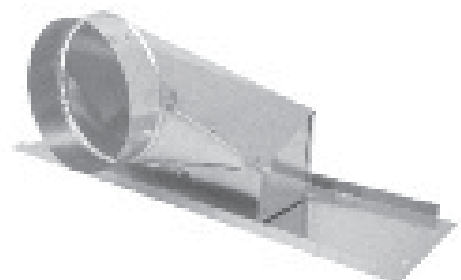

No. 59P
90° CEILING BOX
w/PLATE

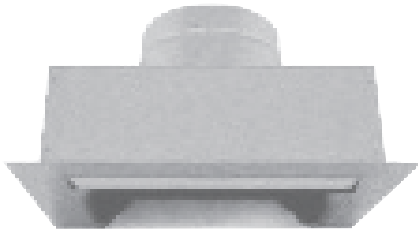

No. 85
INSULATED CEILING
BOX TOP OUTLET

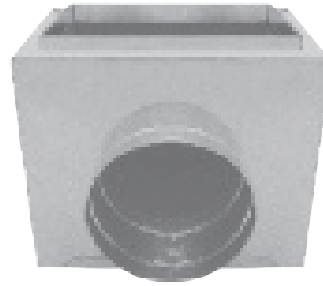

No. 85S
INSULATED CEILING
BOX SIDE OUTLET



No. 31PF
PLASTER FRAME



No. MR
MOUNTING RAILS
Note: Available 24" or 26" long

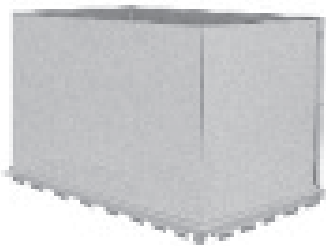

No. 1137
REGISTER COLLAR

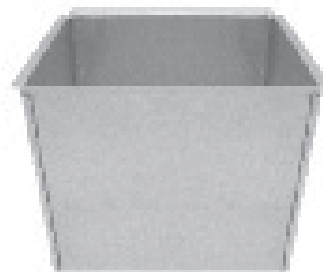

No. 1068
FLOOR REGISTER BOX 5" DEEP
No. 1069
FLOOR REGISTER BOX 10" DEEP

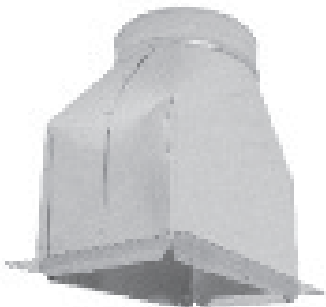

No. 51F
STRAIGHT CEILING BOX
w/FLANGE

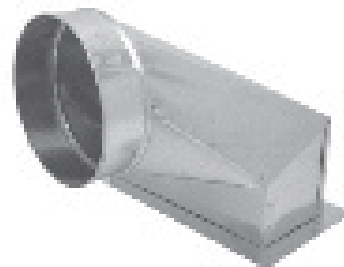

No. 59F
90° CEILING BOX
w/FLANGE

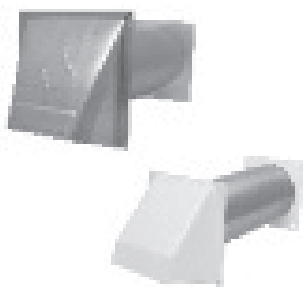

No. SVH
ALUMINUM
VENT HOOD
No. SVHBP
BROWN PLASTIC
No. SVHWP
WHITE PLASTIC



No. 390WP
WHITE LOUVER
HOOD w/TAIL
No. 391WP
FACE ONLY



No. 4008
ALUMINUM PIPE



No. 4005
ALUMINUM
ELBOW



No. SPC
PIPE CLAMP



No. SH
FLEXIBLE
WHITE VINYL HOSE



No. MF
FLEXIBLE
ALUMINUM DUCT



No. SAL
ALUMINUM
TRANSITION DUCT

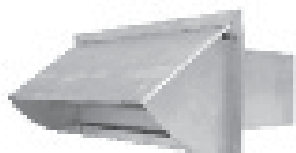

No. 201VH
ALUMINUM
WALL CAP
No. 201VHWP
WHITE PLASTIC

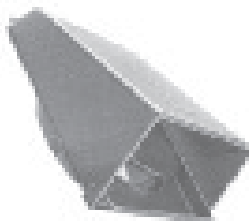

No. 39GP
GRAY PLASTIC
WALL CAP
w/DAMPER
No. 39WP
WHITE PLASTIC

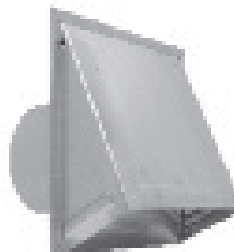

No. 39AL
ALUMINUM
WALL CAP
w/DAMPER

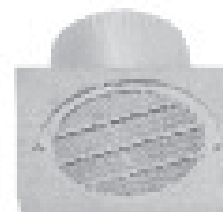

No. EV141
EAVE VENT



No. RV51
ALUMINUM ROOF
CAP w/SCREEN
UP TO 8" ROUND

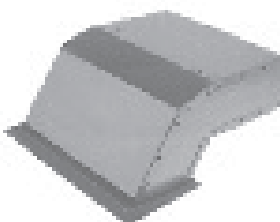

No. 220EC
EAVE VENT
w/GRILLE



ALUMINUM ROOF
CAP w/DAMPER
& SCREEN

No. 239 - FITS 4" DIA.

No. 240 - Up to 7" Rd.

No. 241 - Up to 10" Rd.

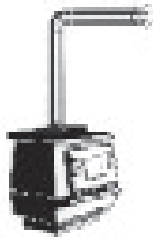

- Available in 5", 6", 7", & 8" Diameters
- 24 Gauge Material
- Heat and Rust Resistant
- Standard Packaging

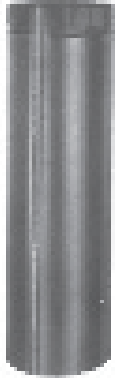

No. BP
SNAPLOCK PIPE
AVAILABLE 12", 24", 36" LENGTHS



No. BP90
90° ADJUSTABLE ELBOW

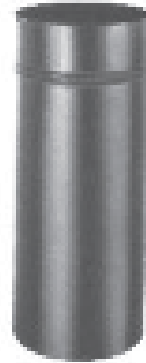

No. BPCHAD
CHIMNEY ADAPTER



No. BP127
OVAL to RD ADAPTER

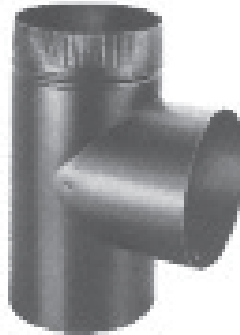

No. BP54
TEE JOINT



No. BP55
TEE CAP



No. BP58
3 Pc. REDUCER



No. BP96
DRAWBAND



No. BPCON
CONNECTOR

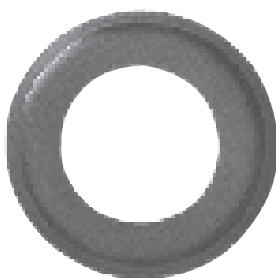

No. BPC
PIPE COLLAR



No. BPTC
TRIM COLLAR

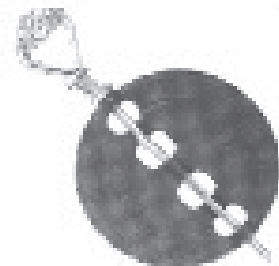

No. CID
CAST IRON DAMPER

**Providing Quality Products,
Superior Service and On-Time Delivery
since 1946.**



Philadelphia Division
Philadelphia, PA
(800) 523-1052
(800) 722-2076 Fax

Greenville Division
Piedmont, SC
(800) 229-2803
(864) 845-6190 Fax

Indianapolis Division
Indianapolis, IN
(800) 490-7707
(317) 823-1006 Fax

Mississippi Division
Southaven, MS
(800) 541-6706
(662) 393-8005 Fax

Nebraska Division
Fremont, NE
(800) 801-0336
(402) 753-9008 Fax

www.southwarkmetal.com