

# Installation Manual

## Humid-A-Mist™ Model HUM-100

### IMPORTANT PLEASE READ BEFORE INSTALLING: NEW FEATURES:

A 15 amp internal bus fuse has been installed on the on the board as a protection device. This fuse will protect the board from improper wiring of the line voltage and over loading the circuits. See page 11 trouble shooting guide for location and replacement procedures.

#### THE FUNCTION OF GAIN SWITCH IS TO TURN ON OR OFF THE BYPASS MODE:

#### OPERATION OF HUM100, WITH GAIN SWITCH IN ON POSITION:

The HUM-100, will work with or without heat. On a call for humidity the humidistat will deliver 24 volts to the red control wire of the HUM-100. The HUM-100, delivers power to the low speed fan terminal and the furnace blower will begin to operate. Once low speed blower is running the HUM-100 will begin to pulse and power the solenoid valve to your time settings. On a call for heat the HUM-100 will go into standby mode locking out humidifier, and shutting down blower. Once the furnace fan limit switch closes and powers the blower, the HUM-100 senses voltage and will go back into humidification. If heat shuts down, the HUM-100 will continue humidifying as needed.

#### OPERATION OF HUM-100 WITH GAIN SWITCH IN OFF POSITION:

In the off position the HUM-100 will only work on a call for heat and a call for humidity.



### DIRECTORY

#### INTERNAL SEQUENCE OF OPERATION

- Page 1) Water piping installation.
- Page 2) Nozzle placement.
- Page 3) Standard wiring diagram.
- Page 4) Heat only.
- Page 5) Standard heat pump/isolated heaters.
- Page 6) Heat pump non isolated heaters.
- Page 7) Electric heat.
- Page 8) Variabe speed.
- Page 9) Humidistat installation.
- Pg 10 ) Pulse times.
- Pg 11) Trouble shooting guide.
- Pg 12) Start-up & Maintenance.
- Pg 13) Parts list.

**ELECTRICAL SPECIFICATIONS: 120 VOLTS AC-60 HZ 10 FLA 30 LRA / 24 VOLTS A/C-60 HZ .425 AMPS  
A 15 AMP GLASS FUSE HAS BEEN INSTALLED IN ELECTRONIC BOARD FOR PROTECTION OF CIRCUIT**

1 Humidifier Control Unit	6 Piggyback connector	3 Brass Pipe inserts
1 Solenoid Valve assembly	8 Solderless wire connectors	1 1/8" MPT X 1/4" comp
1 Water filter & Clip	1 1/4" plastic tubing strap	3 Plastic pipe sleeves
1 Spray Nozzle Assembly	1 1/2" plastic grommet	2 Mounting metal screws
1 1/4" saddle valve	1 Plenum plate assembly	2 Dry way plugs
1 1/8" MPT X 1/4" comp. 90°	10 1/4" plastic tubing	1 Extension rod for H-stat
2 1/4" MPT X 1/4" comp.	1 Humidistat controller	

# INTERNAL SEQUENCE OF OPERATION

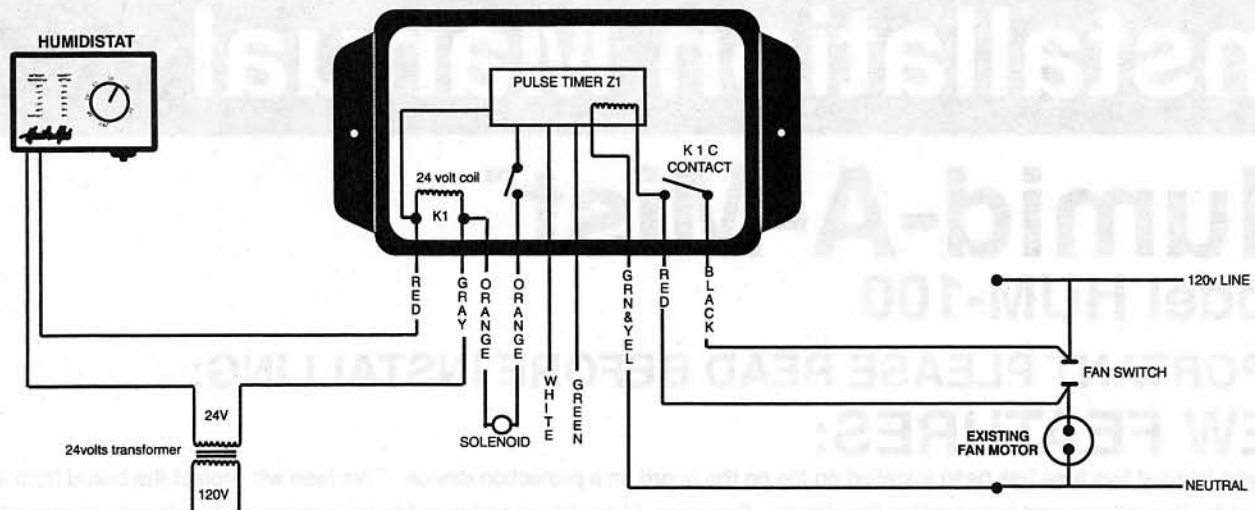

## LOW VOLTAGE CONTROL WIRES.

RED- 24 volt input from humidistat.  
GRAY- 24 volt common of 24v transformer.

ORANGE- 24 volt outputs to the solenoid valve from Hum-100.

WHITE- 24 volt input on a call for heat from thermostat will open K1c contacts.  
GREEN- 24 volts input on a call for fan from thermostat will open K1c contacts.  
(These two wires are sensing wires that will open K1 to the blower.)

GREEN AND YELLOW STRIPED-120 volt common or ground to the pulse timer.

## FAN CONNECTION WIRES.

BLACK- 120 volt input from L1 to K1 relay.  
RED- 120 volts output from switch of K1 relay.

## OPERATION WITH THE GAIN SWITCH ON.

On a call for humidity the humidistat closes and complete a 24 v circuit to the red wire of the HUM-100 energizing K1 relay and closing K1C contacts. (You must have 24 volts across red and gray to close K1C contacts)

K1C contacts transfers 120v power from the black wire to the red powering the fan motor of furnace and to the pulse timer. ( The pulse timer can receive 120 volts two ways, when K1C closes or 120 volts input on red from motor)

The green and yellow striped wire is the 120v common or ground to the pulse timer and must be connected. (The pulse timer will not operate unless 120 volts is present.)

When 120v is present across the red and green & yellow striped wire, the pulse timer will begin to deliver a 24v output voltage on the orange wire to the solenoid valve.

A 24 volt input signal on the white wire ( A call for heat) will open K1C contact and break power to the motor and pulse timer. When the furnace fan limit switch closes and powers the motor it will also power the red wire of the HUM-100 restoring power to the pulse timer to operate the HUM-100.

A 24 volt input signal on the green wire ( A call for high speed fan) will also open K1C contact breaking power to the motor and the pulse timer. The HUM-100 will lock out until the 24 volts is remove from the green wire. (This is a safety feature that will prevent two speed of the motor being powered at the same time.)

## OPERATION WITH THE GAIN SWITCH OFF.

On a call for humidity the Hum-100 will operate the same as above except the gain switch, in the off position will not allow the K1C contact to close preventing the HUM-100 to power the fan motor or pulse timer. The Hum-100 will only operate when the furnace fan limit switch closes powering the furnace blower and powering the red wire of the HUM-100 to the pulse timer.

**NOTE: THE HUM-100 MUST SEE 24 VOLTS FROM THE HUMIDISTAT AND IT MUST ALSO SEE 120 VOLTS FROM THE FAN CIRCUIT BEFORE IT CAN BEGIN TO PULSE.**

## PLACEMENT OF THE MOUNTING OF HUM-100

The Humid-a-mist can be mounted in several location of the furnace. The Hum-100 was designed to be installed inside the furnace blower compartment, or control panel of the furnace. The Hum-100 can also be mounted on the outside of the furnace. Predrilled holes are provided to fasten Hum-100 to furnace.

**Step 1)** Install saddle valve on cold water supply. Do not hook up to water softener.



**Step 2)** Install the 1/8mpt straight compression fitting into the solenoid marked in. Install the 1/8mpt 90 on the outlet of solenoid. Only use teflon tap. Do not use pipe dope or leak lock. If you need to rotate valve remove bottom screws and rotate.



**Step 3)** Install the 1/4mpt fitting into the water filter. If using plastic use the proper sleeve provided.

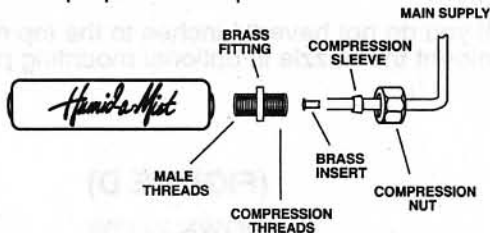

**Step 4)** The filter must be activated by flushing water through it for about five minutes. Using plastic or copper connect from the saddle valve to the inlet of filter. The arrow on filter indicates flow direction. Before connecting the outlet side of filter to solenoid place the outlet of filter in bucket or sink and turn main water supply on and flush filter.

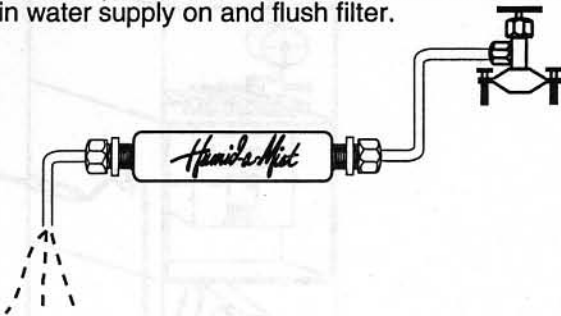

**NOTE:** On attic installations we recommend insulating and/or heat taping water piping to prevent freezing.

**NOTE:** If water has high lime or calcium content, by adding an in-line lime fighter filter before the HUM-100 filter can reduce the plugging of nozzles.

**NOTE:** If you are installing nozzle into a small duct application, we recommend replacing the #012 nozzle with an #08 nozzle. This will provide a smaller mist.

**NOTE:** Do not install the nozzles into a mixing plenum such as a short plenum with 6" round duct take offs. There is no absorption time and condensation will take place.

**NOTE:** Proper air temperatures are 70 degrees and up. If using outside are dampers or economizers wire HUM-100 to operate on a call for heat only.

**Step 5)** After flushing filter, mount the solenoid valve to the furnace using the two hole on the bracket. Mount the white water filter clip and push filter into clip. Connect the outlet side of water filter to the inlet side of the solenoid valve. See figure A.

**Step 6)** Mounting the plenum plate adaptor. (See page 2 for nozzle placement and locations.) Drill a 5/8" hole in the center of the main plenum as close to the furnace as possible. With 1/4" copper (not supplied) make the water feed tube into the plenum. Make a small 90 degree bend to spray with the air flow. Make sure the nozzle is in the center of duct. Assemble the plenum plate, water tube and nozzle holder but do not anchor to duct, you need to flush this line on start up before installing the nozzle.

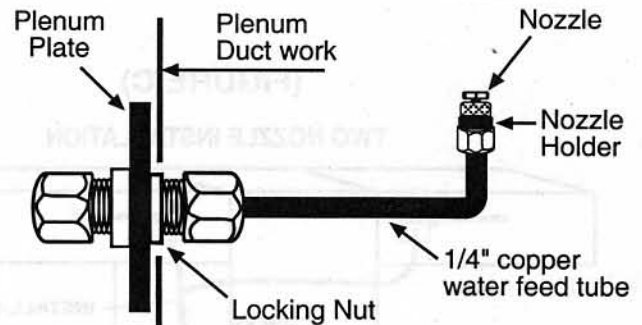

**Step 7)** With 1/4" copper finish the piping from the outlet side of solenoid valve to the plenum plate. After wiring the HUM-100 you must flush the pipe from the outlet of solenoid to the nozzle holder with out the nozzle in place. This will remove any particle in the pipe that could plug nozzle. After you flushed piping install the nozzle into nozzle holder. Do not use a wrench on nozzle, finger tighten only.

## TYPICAL PIPING INSTALLATION

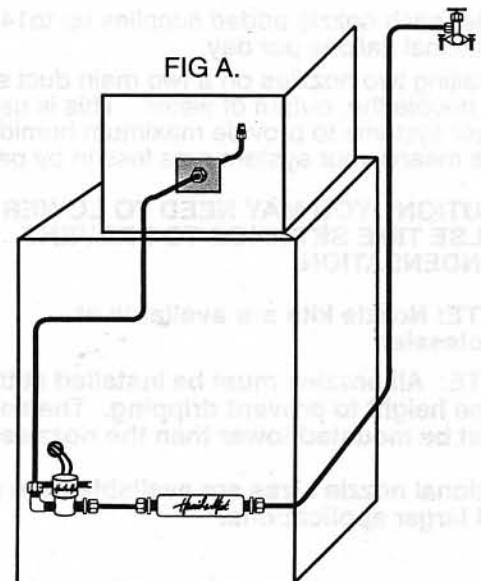

**(FIGURE A)**

**INSTALLATION ON HORIZONTAL UNIT**

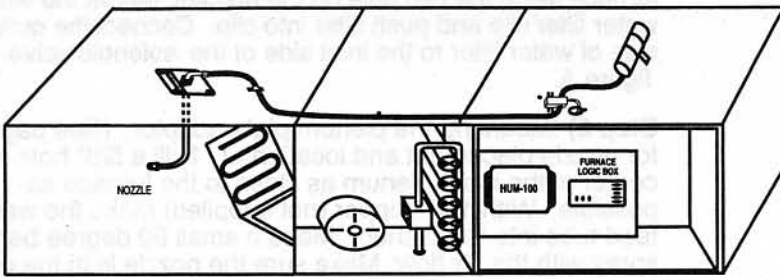

Install nozzle on top or on side of plenum after coil.

**(FIGURE C)**

**TWO NOZZLE INSTALLATION**

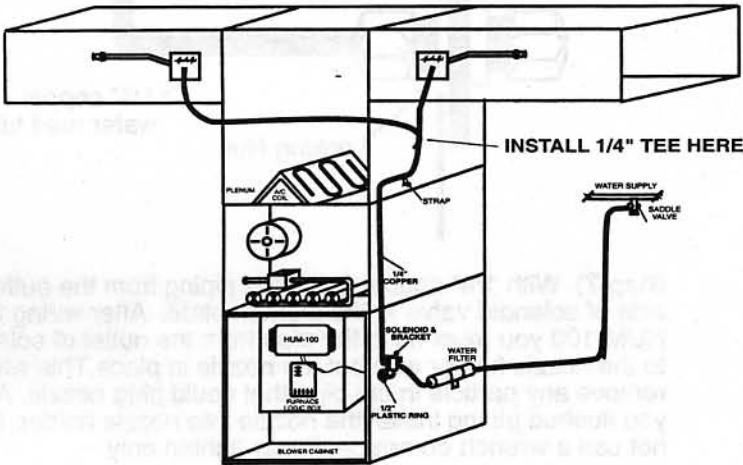

**Note:** each nozzle added supplies up to 14.7 additional gallons per day.

Installing two nozzles on a two main duct system will double the output of water. This is used in larger systems to provide maximum humidity. This means your system runs less in by pass.

**CAUTION: YOU MAY NEED TO LOWER PULSE TIME SETTINGS TO PREVENT CONDENSATION.**

**NOTE:** Nozzle kits are available at wholesaler.

**NOTE:** All nozzles must be installed at the same height to prevent dripping. The solenoid must be mounted lower than the nozzles.

Optional nozzle sizes are available from smaller and larger applications.

**(FIGURE B)**

**INSTALLATION ON A 90 DEG OR PLENUM MOUNT**

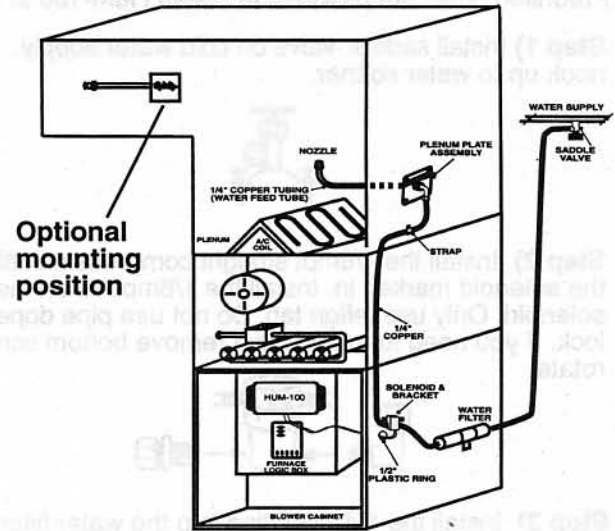

Optional mounting position

If you do not have 24 inches to the top of plenum, mount the nozzle in optional mounting position.

**(FIGURE D)**

**DOWN FLOW**

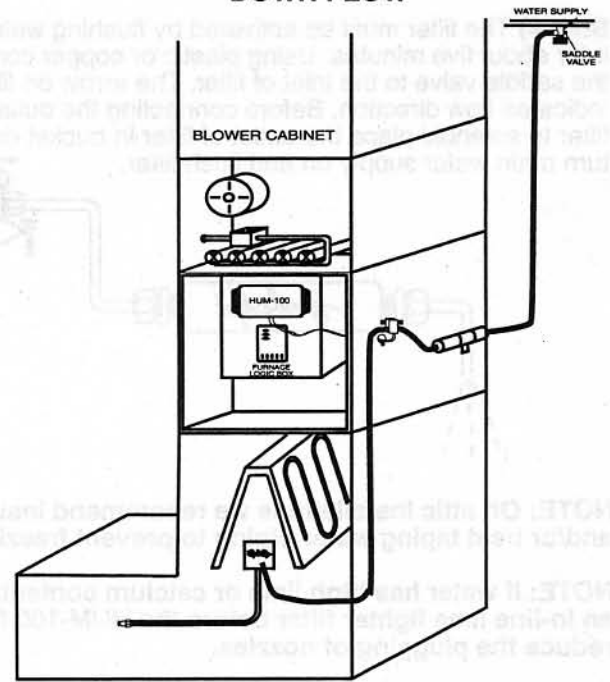

On a downflow you need to place the nozzle past the 90 deg bend to direct the mist into the air flow, as shown in figure D.

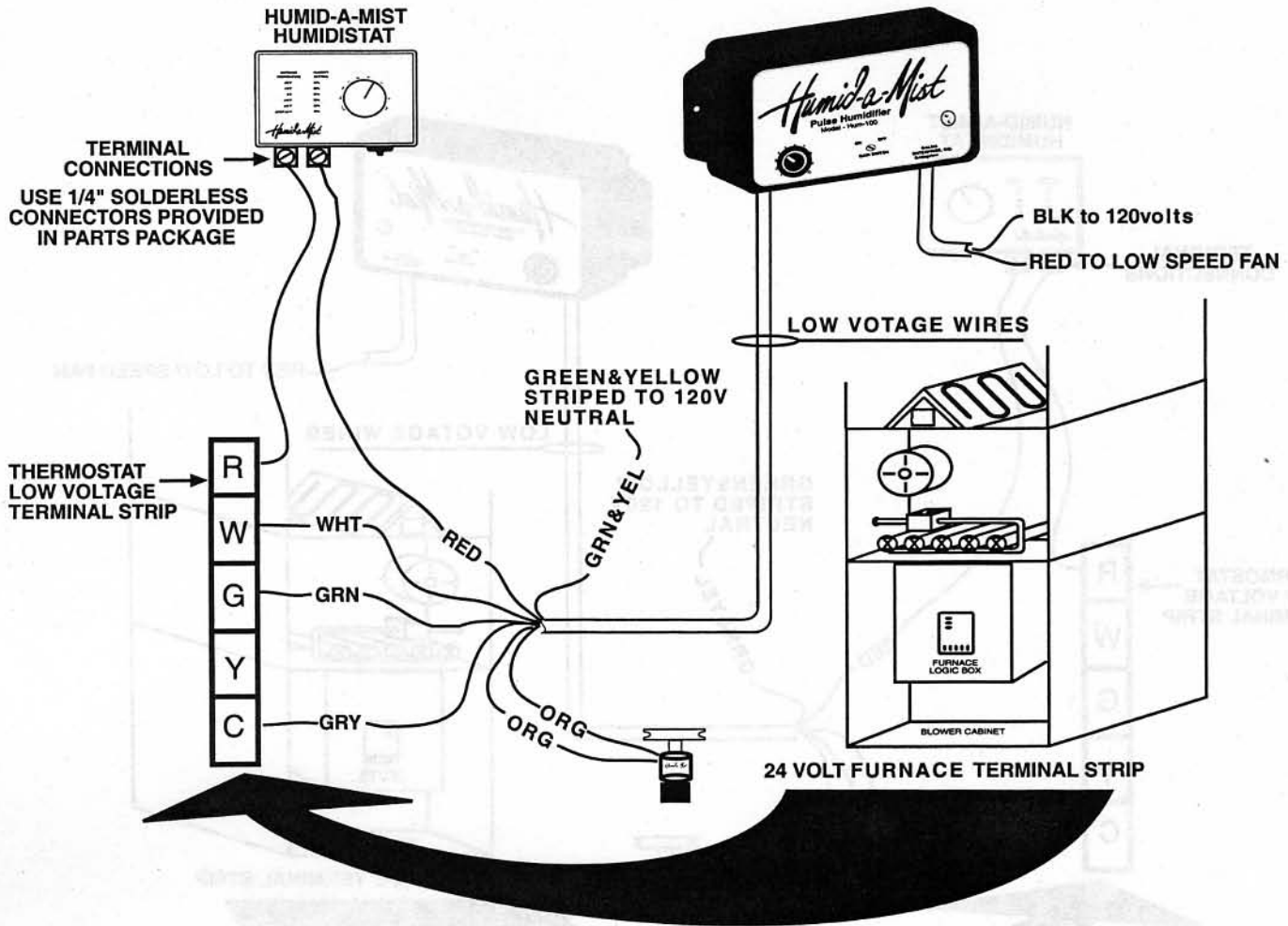

**NOTE: ELECTRICAL CONNECTORS ARE PROVIDED FOR LOGIC BOARD TERMINATION.**

- Step 1)** The red 24v wire from the HUM-100 is the control wire, and is wired to the humidistat terminal. The other terminal is wired to the R terminal of furnace strip.
- Step 2)** The gray is the 24v common and is wired to the C terminal.
- Step 3)** Wire nut both orange wire to the solenoid valve.
- Step 4)** The white wire is wired to the W terminal. This will sense a call for heat.

- Step 5)** The green wire is wired to the G terminal. This will sense a call for high fan.
- Step 6)** The black, and red wires are the fan line voltage wires. The green & yellow striped wire is the ground and is connected to the 120v neutral of the furnace. The black is wired 120v line voltage and the red wire is wired to the low or heating speed of the fan motor.

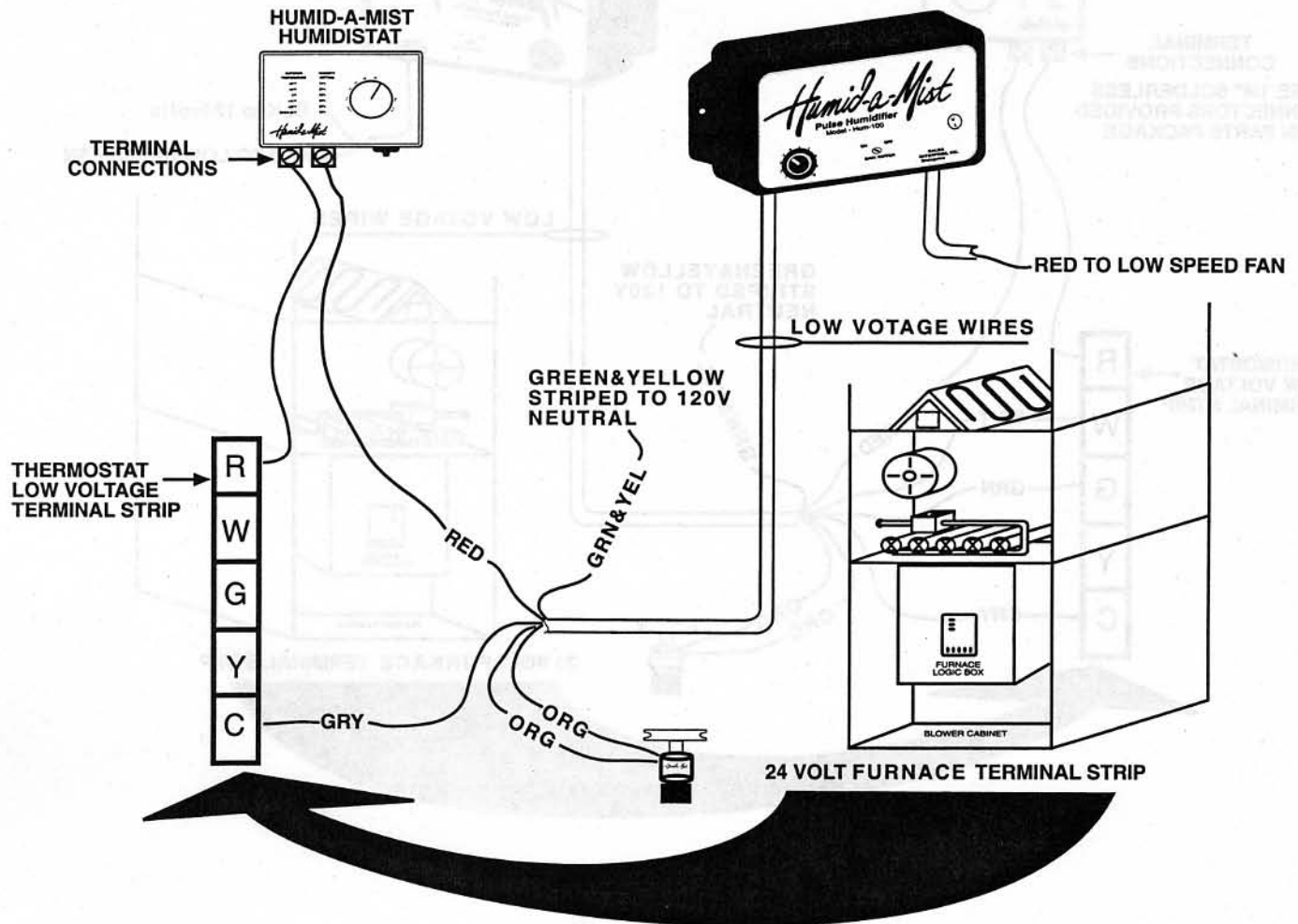

NOTE: ELECTRICAL CONNECTORS ARE PROVIDED FOR LOGIC BOARD TERMINATION.

- Step 1) The red 24v wire from the HUM-100 is the control wire, and is wired to the humidistat terminal. The other terminal is wired to the R terminal of furnace strip.
- Step 2) The gray is the 24v common and is wired to the C terminal.
- Step 3) Wire nut both orange wire to the solenoid valve.
- Step 4) The white and greens are not used.

- Step 5) The black is not used.
- Step 6) The red wire is wired to the low speed of fan motor or speed used in heating operation.
- Step 7) The green & yellow striped wire is the ground and is connected to the 120v neutral of the furnace.

## IF HEATERS ARE NOT ISOLATED FROM FAN CIRCUIT SEE PAGE 6

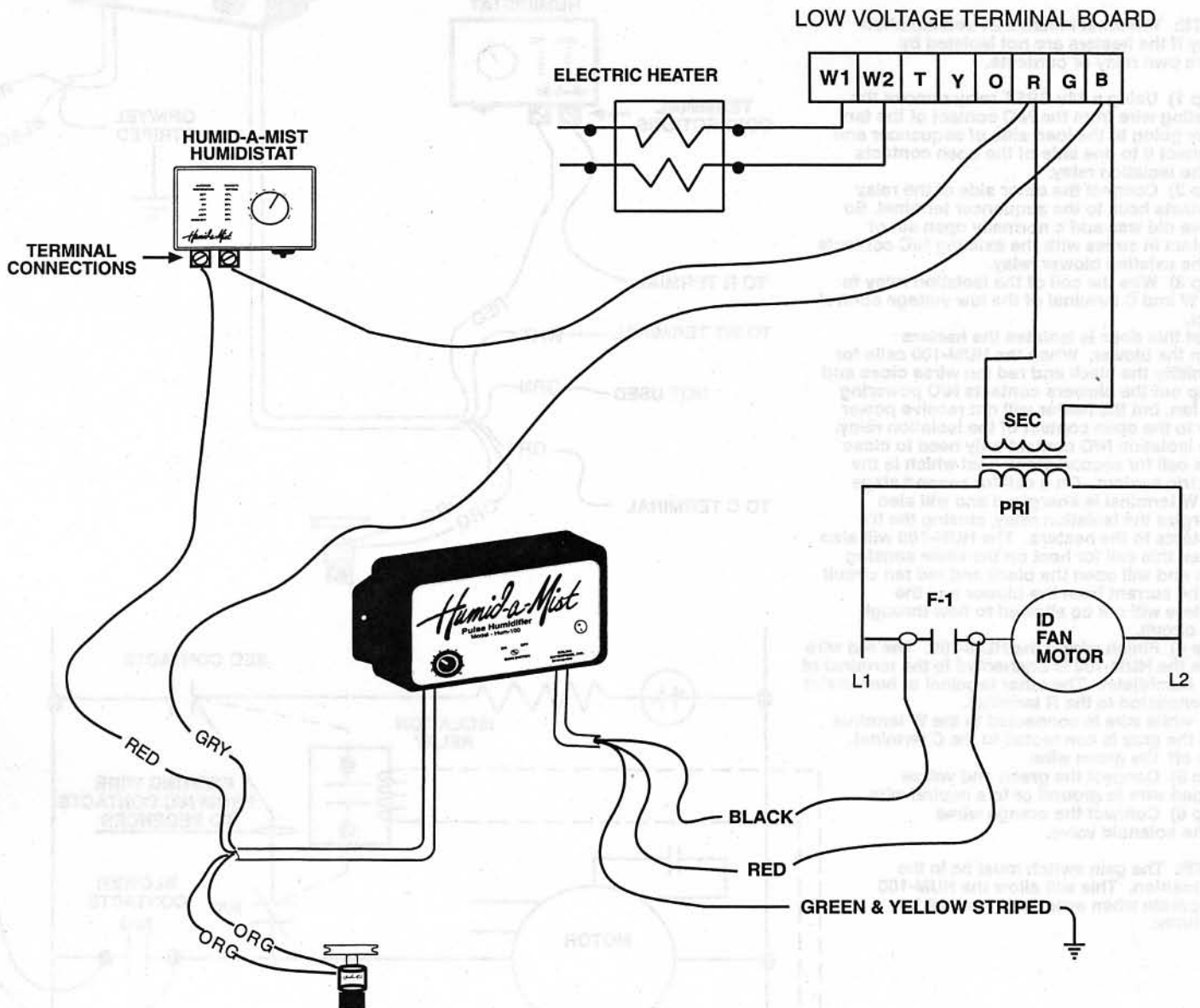

- Step 1)** The red wire is the 24v power to the HUM-100, and is connected to the humidistat terminal. The other terminal is connected to the R terminal or the 24 volt power supply.
- Step 2)** The gray lead is the common of the 24 volts and should be connected to the B terminal, or 24 volt common.
- Step 3)** The Green/Yellow striped wire must be connected to neutral of 120 volt or cabinet ground.
- Step 5)** The White and Green wire of the HUM-100 are not used.
- Step 6)** The Black and Red wires are the fan control leads. Black is connected to the blower relay L1. The red wire is connected to the load side of the blower relay.
- Step 7)** The orange wires are wired to the solenoid valve.

**NOTE:** If system has electric heaters they must be isolated from the fan (F1) relay to prevent them from being powered on a call for humidity. If they are not, the HUM-100 fan connections cannot be used to power fan due to excessive amp draw through HUM-100. A fan sensing switch should be used to prove fans operation.

**WIRING THE HUM-100 TO OPERATE WITH OR WITHOUT HEAT. FOLLOW THE INSTRUCTIONS AND WIRING BELOW.**

**NOTE:** You must install a 24 volt isolation relay if the heaters are not isolated by there own relay or contacts.

**Step 1)** Using a 24v SPST relay remove the existing wire from the N/C contact of the fan relay going to the load side of sequencer and connect it to one side of the open contacts of the isolation relay.  
**Step 2)** Connect the other side of the relay contacts back to the sequencer terminal. So all we did was add a normally open set of contact in series with the existing N/C contacts of the existing blower relay.  
**Step 3)** Wire the coil of the isolation relay to the W and C terminal of the low voltage control strip.  
 What this does is isolates the heaters from the blower. When the HUM-100 calls for humidity the black and red fan wires close and jump out the blowers contacts N/O powering the fan, but the heater will not receive power due to the open contact of the isolation relay. The isolation N/O contact only need to close on a call for second stage heat which is the electric heaters. On a call for second stage the W terminal is energized and will also energize the isolation relay, closing the it's contacts to the heaters. The HUM-100 will also sense this call for heat on the white sensing wire and will open the black and red fan circuit so the current from the blower and the heaters will not be allowed to flow through it's circuit.

**Step 4)** Finish wiring the HUM-100. The red wire from the HUM-100 is connected to the terminal of the humidistat. The other terminal of humidistat is connected to the R terminal. The white wire is connected to the W terminal and the gray is connected to the C terminal. Cap off the green wire.  
**Step 5)** Connect the green and yellow striped wire to ground or to a neutral wire.  
**Step 6)** Connect the orange wires to the solenoid valve.

**NOTE:** The gain switch must be in the on position. This will allow the HUM-100 to operate when ever there is a call for humidity.

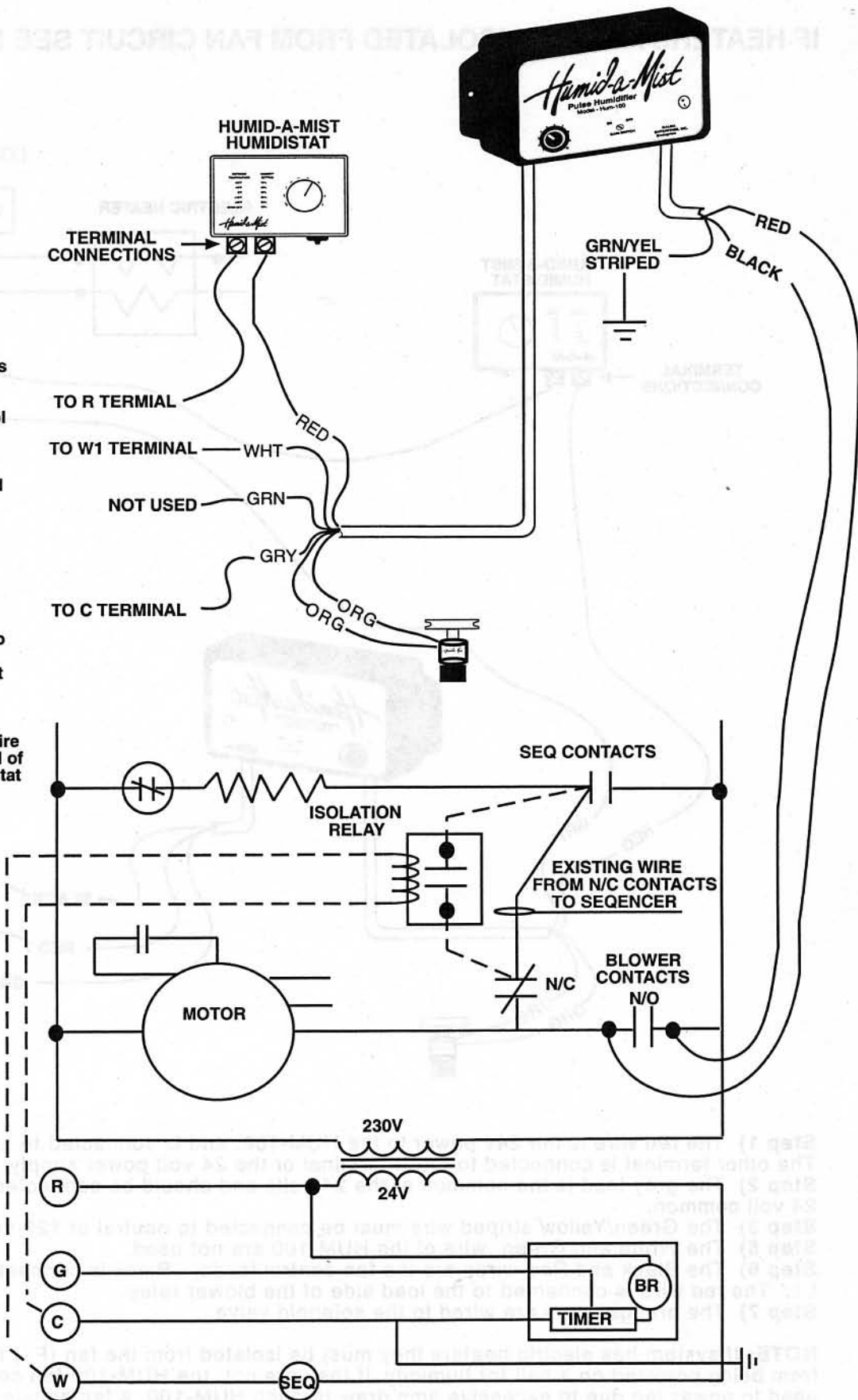



YOU CAN ALSO USE PAGE 6 FOR ELECTRIC HEAT

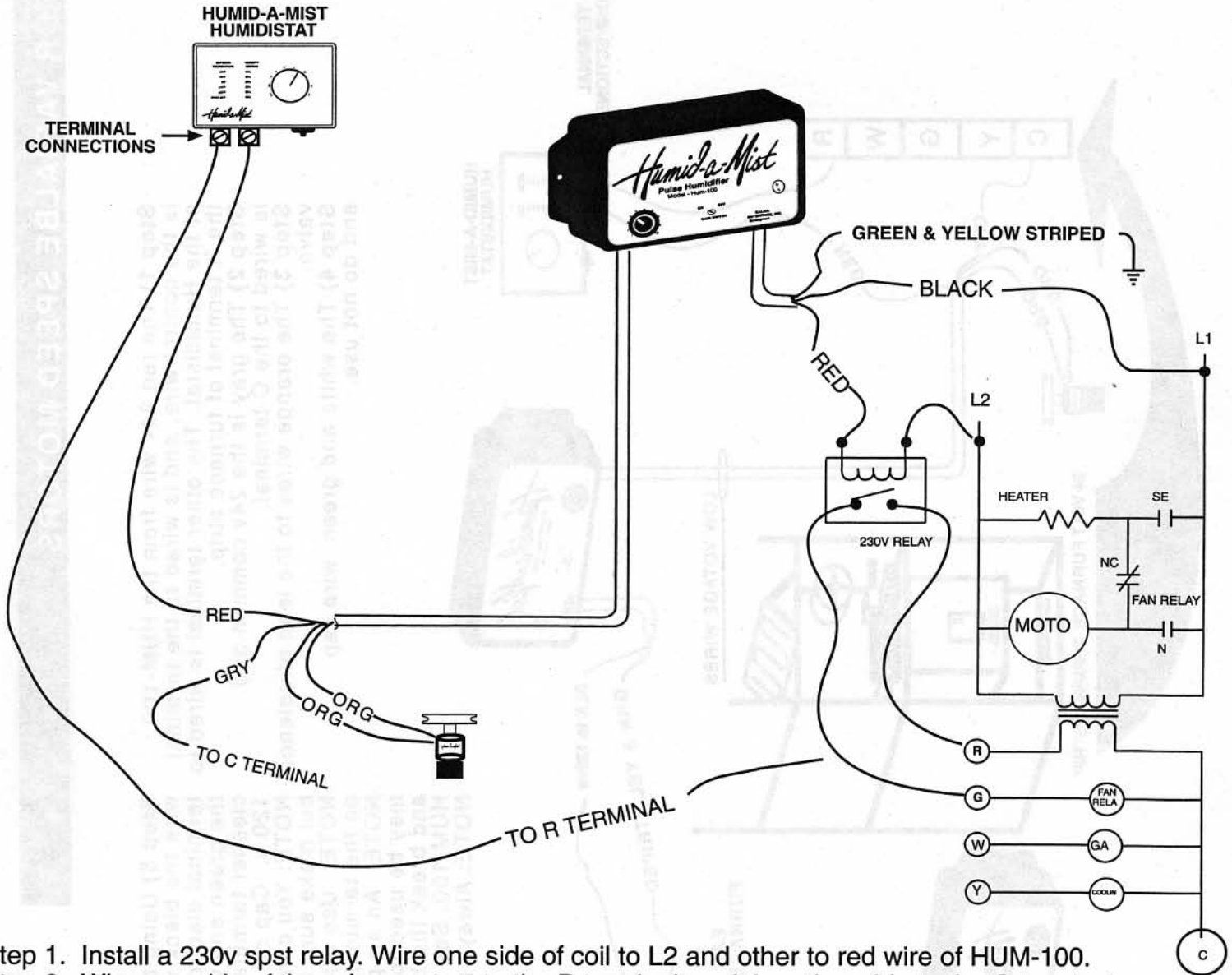

- Step 1. Install a 230v spst relay. Wire one side of coil to L2 and other to red wire of HUM-100.
- Step 2. Wire one side of the relay contact to the R terminal, and the other side to the G terminal.
- Step 3. Connect the green and yellow striped wire to cabinet ground.
- Step 4. Wire orange wires to solenoid valve.
- Step 5. Wire the red wire of the HUM-100 to the terminal of the humidistat, and the other terminal of humidistat to the R terminal. Do not use the white or green on the HUM-100.
- Step 6. Gain switch must be in the on position.

ON A CALL FOR HUMIDITY THE HUM-100 WILL POWER THE ISOLATION RELAY CLOSING CONTACTS TO TERMINAL R AND G POWERING FAN MOTOR AND OPENING THE NORMALLY CLOSED CONTACTS OF THE FAN RELAY TO REMOVE HEATER ELEMENTS FROM THE CIRCUIT.

**NOTE:** IF YOU ONLY WANT TO OPERATE WHEN HEAT IS RUNNING YOU DO NOT USE A ISOLATION RELAY. SIMPLY CAP OFF THE RED FAN WIRE, LEAVE BLACK ON L1. CONNECT THE YELLOW WIRE FROM HUMIDISTAT TO THE W TERMINAL INSTEAD OF THE R TERMINAL. ON A CALL FOR HEAT ONLY WILL HUMIDIFIER OPERATE.

# WIRING FOR VARIABLE SPEED MOTORS

- Step 1)** The red 24v wire from the HUM-100 is the control wire, and is wired to the terminal of the Humidistat. The other terminal is wired to the R terminal of furnace strip.
- Step 2)** The gray is the 24v common and is wired to the C terminal.
- Step 3)** The orange wires to the lead of solenoid valve.
- Step 4)** The white and green wire cap and do not use.

- Step 5)** Using the furnace logic board terminals, wire the black wire from the HUM-100 to the Line terminal electronic air cleaner terminals. Wire the green and yellow striped to the other air cleaner terminal, make sure its the neutral of the 120 v. Cap off the red wire from the HUM-100.
- NOTE:** You can use the terminals marked HUM but make sure the terminals are 120v.
- NOTE:** Use a meter to make the proper connection on the terminals.
- NOTE:** An air proving switch such as a sail switch may be used to prove air. The Switch would make and break the black line voltage wire from the HUM-100. See optional connection below.
- NOTE:** Always maintain over 500 cfm.

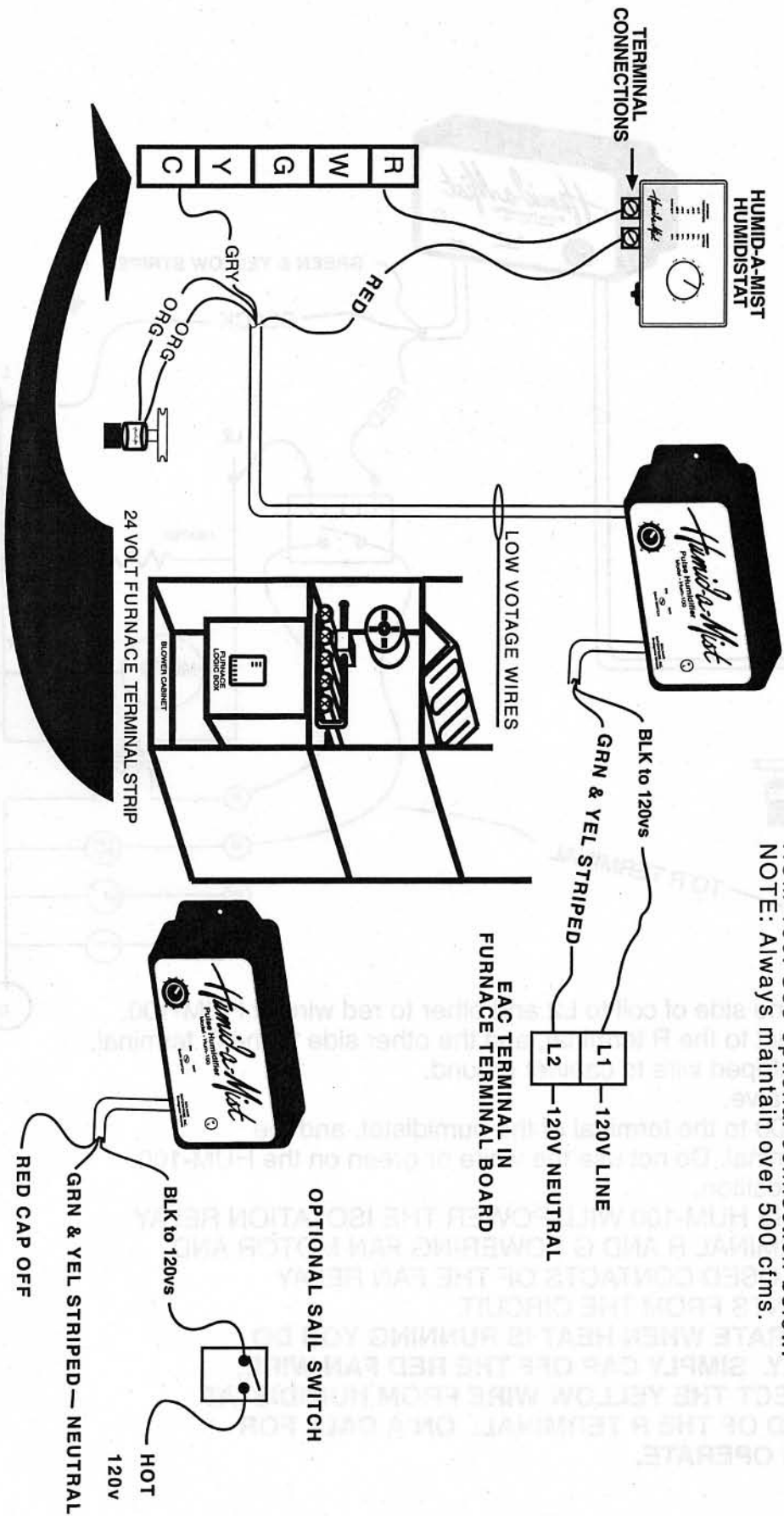

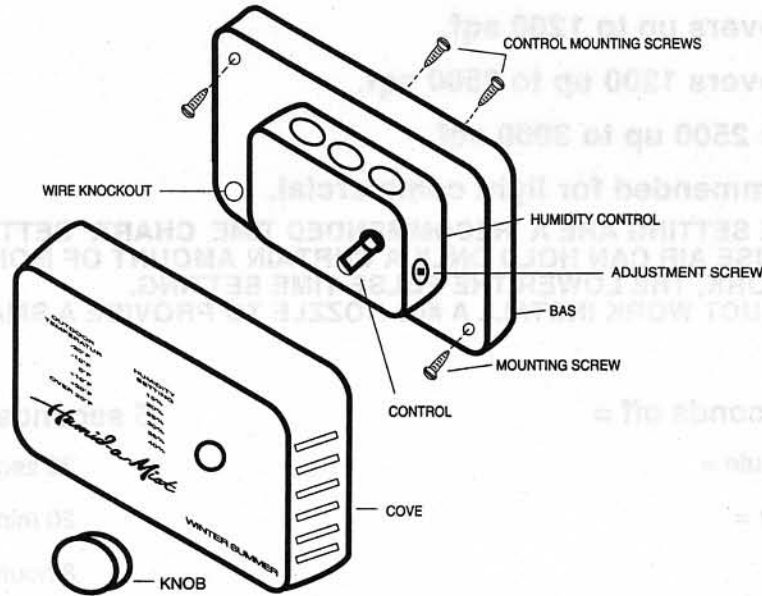

## WALL MOUNT

- Step 1. Remove knob and cover from base.
- Step 2. Place the base against wall and mark wire and mounting holes.
- Step 3. Drill two 3/16 " holes for the drywall anchors and insert anchors.
- Step 4. Drill a 1/2 " hole for the wires, and pull wires through base.
- Step 5. Secure the base to wall with mounting screws.
- Step 6. Using the solderless connectors provided, crimp connector on wires, and push onto humidistats terminals.
- Step 7. Re-install cover and base.

**NOTE: All controls are set at factory. If you need to recalibrate turn the**

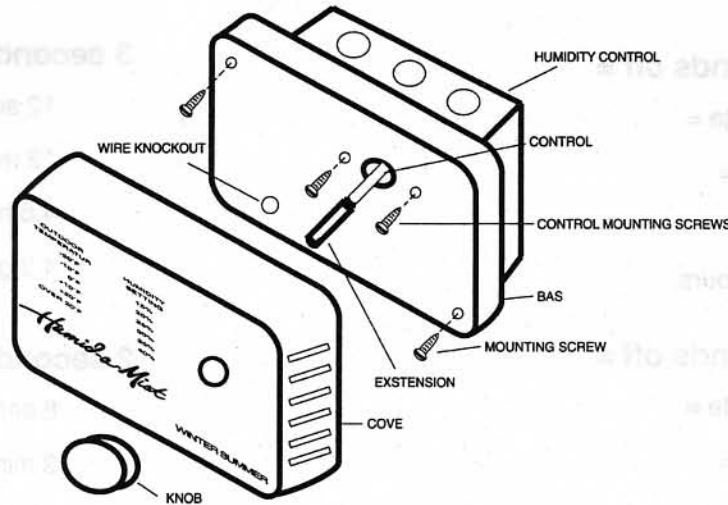

## DUCT MOUNT

- Step 1. Remove knob and cover from base (knob pulls off).
- Step 2. Remove control from base and mount on reverse side.
- Step 3. Connect extension shaft to control shaft.
- Step 4. Using the solderless connectors provided, crimp connector on wires, and push onto humidistats terminals.
- Step 5. Mark and cut out a 1 7/8 inch by 3 1/2 inch hole in return duct.
- Step 6. Place humidity control into hole in plenum and secure base to duct.
- Step 7. Re-install cover and knob.

**Recommended time setting:**

**1 to 3 seconds on covers up to 1200 sqf.**

**4 to 5 seconds on covers 1200 up to 2500 sqf.**

**6 seconds on covers 2500 up to 3000 sqf.**

**7 through 10 is recommended for light commercial.**

**NOTE: THE PULSE TIME SETTING ARE A RECOMMENDED TIME CHART. SETTING WILL VARY ON DUCT SIZES AND CFM. BECAUSE AIR CAN HOLD ONLY A CURTAIN AMOUNT OF MOISTURE AT ONE TIME, THE SMALLER THE DUCT WORK, THE LOWER THE PULSE TIME SETTING.**

**NOTE: FOR SMALLER DUCT WORK INSTALL A #08 NOZZLE TO PROVIDE A SMALLER MIST.**

**10 seconds on, 5 seconds off =**

40 seconds per minute =

40 minutes per hour =

16 hours per day=

14.4 gallons per 24 hours.

**5 seconds on, 10 seconds off =**

20 seconds per minute =

20 minutes per hour =

8 hours per day=

7.2 gallons per 24 hours.

**9 seconds on, 6 seconds off =**

36 seconds per minute =

36 minutes per hour =

14.4 hours per day=

12.1 gallons per 24 hours.

**4 seconds on, 11 seconds off =**

16 seconds per minute =

16 minutes per hour =

6.4 hours per day=

5.8 gallons per 24 hours.

**8 seconds on, 7 seconds off =**

32 seconds per minute =

32 minutes per hour =

12.8 hours per day=

11.5 gallons per 24 hours.

**3 seconds on, 12 seconds off =**

12 seconds per minute =

12 minutes per hour =

4.8 hours per day=

4.3 gallons per 24 hours.

**7 seconds on, 8 seconds off =**

28 seconds per minute =

28 minutes per hour =

11.2 hours per day=

10 gallons per 24 hours.

**2 seconds on, 13 seconds off =**

8 seconds per minute =

8 minutes per hour =

3.2 hours per day=

2.8 gallons per 24 hours.

**6 seconds on, 9 seconds off =**

24 seconds per minute =

24 minutes per hour =

9.6 hours per day=

8.6 gallons per 24 hours.

**1 seconds on, 14 seconds off =**

4 seconds per minute =

4 minutes per hour =

1.6 hours per day=

1.4 gallons per 24 hours.

The HUM-100 must have both 24 volt from the humidistat, and 120 volt from the fan before the board will operate.

Before trouble shooting the HUM-100 make sure of the following:  
 The room thermostat is in the auto position.  
 The thermostat is not calling for heat or cooling.  
 The humidistat is calling for humidity.  
 The humidistat switch is on winter position.  
 The gain switch is turned over to on position.  
 After checking the above items, if needed proceed with trouble shooting steps.

NOTE: If you need to change internal fuse, after closing cover on HUM-100 turn the pulse time setting dial counter clockwise until it stops. Then line up the white indicator line on knob with the number 1 setting and push the knob onto shaft.

**Step 1)** The red and gray wire is the 24v power to the HUM-100. You must have 24vs. If so go to step 2. If not check humidistat summer winter switch or wiring problem.

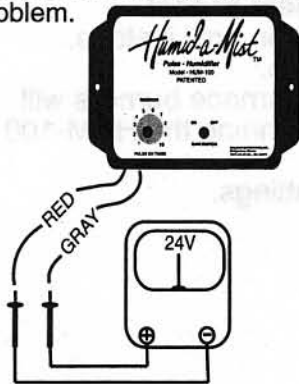

**Step 3)** Shut down power and disconnect the black and red fan wires and place ohm meter across wires. Turn power on. If you have 24v on the red and gray wires from step 1, your meter should read a closed circuit. If so go to step 4. If not, check two possible problems. Shut down power, using a small screwdriver pop the cover open and check the 15amp fuse. If blown replace fuse. If good replace cover and disconnect the green and white wire from the HUM-100 and repeat step 3. If you read a closed circuit your room thermostat is leaking voltage on the white or green leg. With power on, touch the white wire to the W terminal, and then the green to the G. If your meter reads an open circuit when you touch the white wire leave off. If circuit reads open with the green wire, replace your room thermostat.

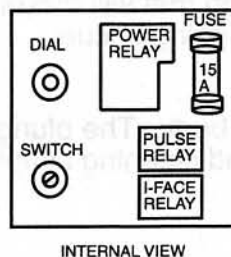
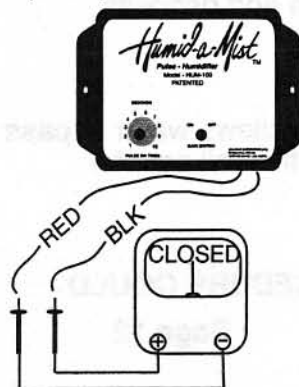

**Step 2)** Check for 120v on the black fan wire and the green/yellow striped wire. If yes, go to step 3. If not check wiring. You must have 120v across black and green/yellow striped.

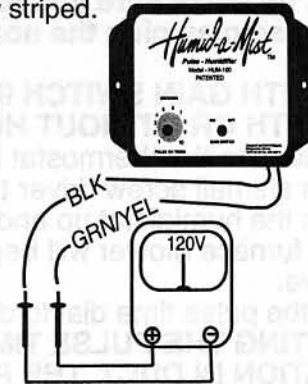

**Step 4)** Shut down power. Connect the red fan wire to 120v line voltage. Turn power on and check for 120v across the red fan wire and the green/yellow striped. If you read 120v go to step 5. If not check for improper wiring.

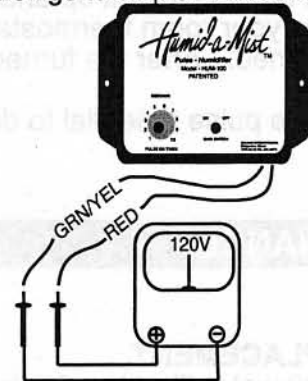

**Step 5)** If you have 24v, as in step one. And you have 120v as in step 4, you should read pulses of 24v across the two orange wires. Or the solenoid valve should begin to pulse at the time setting of the dial. If you read 24v or solenoid is pulsing, board is operational. If not board is defective.

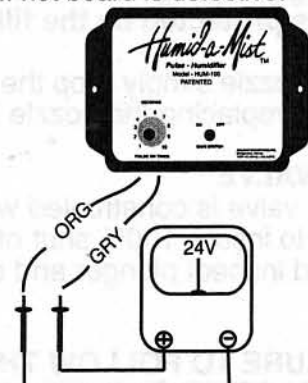

**CAUTION IS ADVISED WHEN TROUBLE SHOOTING LINE VOLTAGE:**

**Before start up make sure you have activated the filter and flushed the water tubing. Failure to do so may clog the nozzles and dripping may occur.**

**START UP WITH GAIN SWITCH IN ON POSITION. IN THE ON POSITION THE HUM-100 WILL OPERATE WITH OR WITHOUT HEAT.**

- Step 1) Make sure the thermostat is in the auto position and is not calling for heat or cool.
- Step 2) With a small screw driver turn the gain switch counter clockwise to the on position until it stops.
- Step 3) Turn the humidistat up and make sure the switch is in the winter position.
- Step 4) The furnace blower will begin to run. After a few seconds the pulse timer with power the solenoid valve.
- Step 5) Set the pulse time dial to desired time settings. See page 12 for time setting.

**NOTE: SETTING THE PULSE TIMES TO HIGH MAY CAUSE OVER HUMIDIFICATION OR CONDENSATION IN DUCT. THE PULSE TIMES ARE A GUIDE TO FOLLOW BUT MAY NOT BE CORRECT FOR EVERY APPLICATION. PULSE TIMES WILL VARY DEPENDING ON THE SIZE OF DUCT AND THE AIR VOLUME.**

**START UP WITH GAIN SWITCH IN THE OFF POSITION. IN THE OFF POSITION THE HUM-100 WILL OPERATE ONLY ON A CALL FOR HEAT, AND A CALL FOR HUMIDITY.**

- Step 1) Make sure the thermostat is in the auto position and is not calling for heat or cool.
- Step 2) With a small screw driver turn the gain switch clockwise to the off position until it stops.
- Step 3) Turn the humidistat up and make sure the switch is in the winter position.
- Step 4) Place your room thermostat to the heat position and turn up stat. The furnace burners will ignite as designed. After the furnace blower limit switch makes and blower is running the HUM-100 will begin to pulse.
- Step 5) Set the pulse time dial to desired time setting. See page 8 for time settings.

**MAINTENANCE****FILTER REPLACEMENT**

The HUM-100 water filter is a 5 micron filter and is made for the Humid-a-Mist system. Failure to use our filter may cause nozzles to clog and water damage may occur. Always replace with Humid-a-Mist water filter W-500.

**The water filter is good for one season only and must be changed be for each winter start up.** In some areas where water has a high mineral content the filter will have to be changed more often. Failure to replace filter may cause clogging of nozzles witch could lead to water damage.

**NOZZLE REPLACEMENT**

Our nozzle is made up of brass and stainless steel. A stainless ball bearing orifice spins when water passes through causing water to break down into a fine mist.

**The nozzle is protected by the filter but will have to be replaced or cleaned every season before start up.**

To clean the nozzle simply drop the nozzle in CLR or any solution that will dissolve lime and deposits. In most cases replacing the nozzle is the best solution when clogging occurs.

**SOLENOID VALVE**

The solenoid valve is constructed with a epoxy coil and a brass body. The plunger that allows water to pass is over sized to insure 100% shut off. If the solenoid should need cleaning simply turn the coil counter clockwise and inspect plunger and orifice for possible clogging.

**NOTE: FAILURE TO FOLLOW THE MAINTENANCE GUIDES OR START UP PROCEDURE COULD CAUSE DAMAGE TO SYSTEM OR CAUSE WATER DAMAGE.**

PART NUMBER	DESCRIPTION
HUM-100-P	PULSE BOARD



PART NUMBER	DESCRIPTION
W-500	WATER FILTER
FC-325	FILTER CLIP

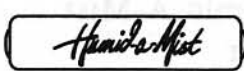

PART NUMBER	DESCRIPTION
F-15	15 AMP FUSE INTERNAL FUSE IN HUM-100



PART NUMBER	DESCRIPTION
HUM-200	STANDARD HUM-STAT



PART NUMBER	DESCRIPTION
NZ-08	1/2 GAL NOZZLE
NZ-012	1 GAL NOZZLE STANDARD IN KIT
NZ-015	1.5 GAL NOZZLE
NZ-120	2 GAL NOZZLE



PART NUMBER	DESCRIPTION
BR-1024	NOZZLE HOLDER



PART NUMBER	DESCRIPTION
NK-101	NOZZLES KIT FOR ADDING DUAL NOZZLES



PART NUMBER	DESCRIPTION
BR-4M4C	1/4MPTX1/4COMP FILTER FITTINGS
BR-8M4C	1/8MPTX1/4COMP SOLENOID FITTINGS
BR-8M4C90	1/8MPTX1/4 COMP

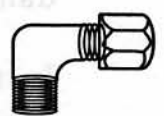
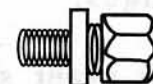
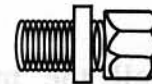

PART NUMBER	DESCRIPTION
S-24	SOLENOID



PART NUMBER	DESCRIPTION
SV-25	SADDLE VALVE



PART NUMBER	DESCRIPTION
PS-01	1/4" TUBING



HUMID-A-MIST  
PULSE HUMIDIFIER  
TWO YEAR WARRANTY

This warranty is extended to the original consumer purchaser, and applies to products purchased and retained for use in the U.S.A. All warranties are voided unless installed by qualified technician.

All parts of the Humid-A-Mist Product Line are warranted from defect in material and workmanship for a period of two years from date of purchase, excluding filter and nozzle.

Galmar Enterprise Inc. will replace free of charge, any warranted part which proves to be defective in material and/or workmanship, under normal installation, use and service. Any damage to the Humid-A-Mist Products, caused by misuse, abuse, neglect, accident, improper installation/application or any other use contrary to the instruction furnished by Galmar Enterprises Inc., and any consequential damage resulting there from will void the warranty and the manufacturer will not be liable for such damages.

In no event shall the manufacturer be liable for any incidental or consequential damages resulting from any failure of the Humid-A-Mist System due to damage caused by failure to follow recommended installation procedures. In no event shall the manufacturer be liable for any incidental or consequential damages resulting from contaminate in water being minerals, salts or any other agents.

This warranty is limited to the replacement of defective parts only. Labor charges incurred in the installation and/or replacement as well as incidental and consequential damages connected there with are excluded.

Certain states do not allow the exclusion or limitation of incidence or consequential damages, the above limitation or exclusion may not apply to you.

Replacement parts can be obtained from your local dealer and/or by returning the part to Galmar Enterprise Inc. Any parts returned for warranty, and test out to be operational by Galmar Enterprise, the parts will be returned at the cost of shipper. Transportation prepaid to our factory at the address listed below.

Galmar Enterprise Inc.  
New Lenox, IL 60451