

AIR CONDITIONER

Wall mounted type

SERVICE MANUAL

INDOOR



ASUH18LMAS



ASUH24LMAS

OUTDOOR



AOUH18LMAS1
AOUH24LMAS1

FUJITSU GENERAL LIMITED

Notices:

- Product specifications and design are subject to change without notice for future improvement.
- For further details, please check with our authorized dealer.

Trademarks

FGLair™ is trademark of Fujitsu General Limited in the United States, other countries or both.

Google Play™ is trademark of Google LLC.

App Store® is a service mark of Apple Inc., registered in the U.S. and other countries.

CONTENTS

1. GENERAL INFORMATION

2. TECHNICAL DATA AND PARTS LIST

3. TROUBLESHOOTING

4. CONTROL AND FUNCTIONS

5. FIELD WORKING

1. GENERAL INFORMATION

CONTENTS

1. GENERAL INFORMATION

1. Specifications	01-1
1-1. Indoor unit	01-1
1-2. Outdoor unit.....	01-3
2. Dimensions	01-4
2-1. Indoor unit	01-4
2-2. Outdoor unit.....	01-8

1. Specifications

1-1. Indoor unit

Type			Wall mounted		
			Inverter heat pump		
Model name			ASUH18LMAS	ASUH24LMAS	
Power supply			208/230 V ~ 60 Hz		
Power supply intake			Outdoor unit		
Available voltage range			187—253 V		
Capacity	Cooling	Rated	kW	5.28	6.45
			Btu/h	18,000	22,000
		Min.—Max.	kW	2.05—5.86	2.67—8.00
			Btu/h	7,000—20,000	9,100—27,300
	Heating	Rated	kW	6.33	7.39
			Btu/h	21,600	25,200
		Min.—Max.	kW	2.34—8.50	2.40—10.84
			Btu/h	8,000—29,000	8,200—37,000
	Heating (17°F) ¹	Rated	kW	3.99	4.60
			Btu/h	13,600	15,700
		Max.	kW	6.95	8.41
			Btu/h	23,700	28,700
Heating (5°F) ²	Rated	kW	6.33	7.33	
		Btu/h	21,600	25,000	
	Max.	kW	6.33	7.47	
		Btu/h	21,600	25,500	
Input power	Cooling	Rated	kW	1.38	1.76
		Min.—Max.		0.45—1.86	0.43—2.63
	Heating	Rated		1.58	1.87
		Min.—Max.		0.55—2.82	0.52—3.53
	Heating (17°F) ¹	Rated		1.28	1.51
		Max.		0.41—3.06	0.39—3.60
	Heating (5°F) ²	Rated		3.15	3.58
		Max.		3.15	3.60
Current	Cooling	Rated	A	6.2	7.8
	Heating		7.0	8.3	
EER2	Cooling	kW/kW	3.82	3.66	
		Btu/hW	13.0	12.5	
COP2	Heating	kW/kW	4.00	3.96	
		Btu/hW	13.6	13.5	
SEER2	Cooling	Btu/hW	21.1	22.5	
HSPF2	Heating	Btu/hW	11.5	11.4	
Power factor	Cooling	%	96.8	98.1	
	Heating		98.1	98.0	
Moisture removal			pints/h (L/h)	4.0 (1.9)	6.3 (3.0)
Maximum operating current ³			Cooling	A	13.4
			Heating		13.9
Fan	Airflow rate	Cooling	HIGH	577 (980)	647 (1,100)
			MED	489 (830)	530 (900)
			LOW	377 (640)	436 (740)
			QUIET	300 (510)	371 (630)
		Heating	HIGH	589 (1,000)	730 (1,240)
			MED	500 (850)	530 (900)
			LOW	377 (640)	436 (740)
			QUIET	300 (510)	371 (630)
	Type × Q _{ty}			Crossflow fan × 1	
	Motor output			W	59
Sound pressure level ⁴	Cooling	HIGH	dB (A)	46	46
		MED		41	42
		LOW		35	37
		QUIET		30	33
	Heating	HIGH		46	48
		MED		41	38
		LOW		35	34
		QUIET		30	30
Heat exchanger type	Dimensions (H × W × D)		in (mm)	Main 1: 8-1/4 × 31-5/16 × 1-1/16 (210 × 796 × 26.6) Main 2: 4-15/16 × 31-5/16 × 1-1/16 (126 × 796 × 26.6) Sub 1: 3-5/16 × 31-5/16 × 1/2 (84 × 796 × 13.3)	18-3/16 × 35-6/16 × 1-1/16 (462 × 898 × 26.6)
	Fin pitch		FPI (mm)	Main 1: 21 (1.2) Main 2: 21 (1.2) Sub 1: 18 (1.4)	21 (1.2)
	Rows × Stages			Main 1: 2 × 10 Main 2: 2 × 6 Sub 1: 1 × 4	2 × 22
	Pipe type			Copper	
	Fin type			Aluminum	
	Material			Polystyrene	
Enclosure	Color		White Approximate color of Munsell N 9.25/		
	Dimensions (H × W × D)	Net	in (mm)	11 × 38-9/16 × 9-7/16 (280 × 980 × 240)	13-6/16 × 45-4/16 × 11 (340 × 1,150 × 280)
Gross		12-11/16 × 42-7/16 × 13-5/8 (322 × 1,078 × 346)		15-15/16 × 50 × 17-11/16 (405 × 1,270 × 450)	
Weight	Net	lb (kg)	29 (13.0)	36 (16.5)	
	Gross		36 (16.5)	49 (22.0)	

Type				Wall mounted	
				Inverter heat pump	
Model name				ASUH18LMAS	ASUH24LMAS
Connection pipe	Size	Liquid	in (mm)	Ø3/8 (Ø9.52)	
		Gas		Ø5/8 (Ø15.88)	
	Method	Flare			
Drain hose	Material	PP+HDPE			
	Tip diameter		in (mm)	Ø17/32 (Ø13.8) (I.D.), Ø19/32 to 21/32 (Ø15.0 to 16.8) (O.D.)	
Operation range	Cooling		°F (°C)	64 to 90 (18 to 32)	
			%RH	80 or less	
	Heating		°F (°C)	86 (30) or less	
Remote controller type				Wireless (Wired, , Mobile app ^{*5} [FGLair™][option])	

NOTES:

- Specifications are based on the following conditions:
 - Cooling: Indoor temperature of 80°FDB (26.67°CDB) /67°F WB (19.44°CWB), and outdoor temperature of 95°FDB (35°CDB) / 75°F WB (23.9°CWB).
 - Heating: Indoor temperature of 70°FDB (21.11°CDB) /59°F WB (15.56°CWB), and outdoor temperature of 47°FDB (8.33°CDB) /43°F WB (6.11°CWB).
 - *1: Heating (17°F): Indoor temperature of 70°FDB (21.11°CDB) /60°F WB (15.56°CWB), and outdoor temperature of 17°FDB (-8.33°CDB) /15°F WB (-9.44°CWB).
 - *2: Heating (5°F): Indoor temperature of 70°FDB (21.11°CDB) /60°F WB (15.56°CWB), and outdoor temperature of 5°FDB (-15.0°CDB) /4°F WB (-15.56°CWB).
 - Test conditions are based on AHRI 210/240 2023.
 - Pipe length: 25 ft (7.5 m), Height difference: 0 ft (0 m). (Between outdoor unit and indoor unit.)
- Protective function might work when using it outside the operation range.
- *3: Maximum current is maximum value when operated within the operation range.
- *4: Sound pressure level:
 - Measured values in manufacturer's anechoic chamber.
 - Because of the surrounding sound environment, the sound levels measured in actual installation conditions might be higher than the specified values here.
- *5: Available on Google Play™ store or on App Store®. Optional WLAN adapter is also required. For details, refer to the setting manual.

M condition						
Model name				ASUH18LMAS	ASUH24LMAS	
Capacity	Cooling	Rated	kW	5.28	6.45	
			Btu/h	18,000	22,000	
		Min.—Max.	kW	2.05—5.86	2.67—8.00	
			Btu/h	7,000—20,000	9,100—27,300	
		Heating	Rated	kW	6.33	7.39
				Btu/h	21,600	25,200
	Min.—Max.		kW	2.34—8.50	2.40—10.84	
			Btu/h	8,000—29,000	8,200—37,000	
	Heating (17°F)*	Rated	kW	3.99	4.60	
			Btu/h	13,600	15,700	
		Max.	kW	6.95	8.41	
			Btu/h	23,700	28,700	
Input power	Cooling	Rated	kW	1.38	1.76	
				Min.—Max.	0.45—1.86	0.43—2.63
	Heating	Rated		1.58	1.87	
				Min.—Max.	0.55—2.82	0.52—3.53
	Heating (17°F)*	Rated		1.28	1.51	
				Max.	0.41—3.06	0.39—3.60
Current	Cooling	Rated	A	6.2	7.8	
	Heating		7.0	8.3		
EER	Cooling	kW/kW	3.80	3.66		
		Btu/hW	13.0	12.5		
COP	Heating	kW/kW	4.00	3.96		
		Btu/hW	13.6	13.5		
SEER	Cooling	Btu/hW	21.1	22.5		
HSPF	Heating	Btu/hW	12.5	12.0		
Power factor	Cooling	%	96.8	98.1		
	Heating		98.1	98.0		

NOTES:

Specifications are based on the following conditions:

- Cooling: Indoor temperature of 80°FDB (26.67°CDB) /67°F WB (19.44°CWB), and outdoor temperature of 95°FDB (35°CDB) /75°F WB (23.9°CWB).
- Heating: Indoor temperature of 70°FDB (21.11°CDB) /59°F WB (15.56°CWB), and outdoor temperature of 47°FDB (8.33°CDB) /43°F WB (6.11°CWB).
- *: Heating (17°F): Indoor temperature of 70°FDB (21.11°CDB) /60°F WB (15.56°CWB), and outdoor temperature of 17°FDB (-8.33°CDB) /15°F WB (-9.44°CWB).
- Test conditions are based on AHRI 210/240 2017.
- Pipe length: 25 ft (7.5 m), Height difference: 0 ft (0 m). (Between outdoor unit and indoor unit.)

1-2. Outdoor unit

Type			Inverter heat pump		
Model name			AOUH18LMAS1	AOUH24LMAS1	
Power supply			208/230 V ~ 60 Hz		
Power supply intake			Outdoor unit		
Available voltage range			187–253 V		
Starting current			A		
			7.0	8.3	
Fan	Airflow rate	Cooling	CFM (m ³ /h)	1,683 (2,860)	1,936 (3,290)
		Heating			
	Type × Q'ty	Propeller fan × 1			
Motor output			W	100	
Sound pressure level *1			Cooling	49	52
			Heating	50	54
Heat exchanger type			Dimensions (H × W × D)	Main 1: 29-3/4 × 35-5/8 × 11/16 (756 × 905 × 18.19) Main 2: 29-3/4 × 35-5/8 × 11/16 (756 × 905 × 18.19)	
			Fin pitch	Main 1: 18 (1.45) Main 2: 18 (1.45)	
			Rows × Stages	Main 1: 1 × 36 Main 2: 1 × 36	
			Pipe type	Copper	
			Fin type	Aluminum	
			Type (Material)	Blue fin	
			Surface treatment		
Compressor			Type	DC twin rotary	
			Motor output	W	
				1,360	
Refrigerant			Type	R410A	
			Charge	3 lb 15 oz	4 lb 10 oz
				1,800	2,100
Refrigerant oil			Type	POE (RB68)	
			Amount	in ³ (cm ³)	
				48.8 (800)	
Enclosure			Material	Steel sheet	
			Color	Beige	
				Approximate color of Munsell 10YR 7.5/1.0	
Dimensions (H × W × D)			Net	31 × 37 × 12-5/8 (788 × 940 × 320)	
			Gross	38-1/16 × 40-7/16 × 17-1/2 (966 × 1,027 × 445)	
Weight			Net	117 (53)	
			Gross	134 (61)	
Connection pipe			Size	Liquid	Ø3/8 (Ø9.52)
				Gas	Ø5/8 (Ø15.88)
			Method	Flare	
			Pre-charge length	49 (15)	66 (20)
			Max. length	164 (50)	
			Max. height difference	98 (30)	
Drain hose			Material	LDPE	
			Tip diameter	Ø1/2 (Ø13.0) (I.D.), Ø5/8 to 11/16 (Ø16.0 to 16.7) (O.D.)	
Operation range			Cooling	14 to 115 (-10 to 46)	
			Heating	5 to 75 (-15 to 24)	
NOTES:					
<ul style="list-style-type: none"> • Specifications are based on the following conditions: <ul style="list-style-type: none"> – Cooling: Indoor temperature of 80 °FDB (26.67 °CDB) / 67 °FWB (19.44 °CWB), and outdoor temperature of 95 °FDB (35 °CDB) / 75 °FWB (23.9 °CWB). – Heating: Indoor temperature of 70 °FDB (21.11 °CDB) / 59 °FWB (15 °CWB), and outdoor temperature of 47 °FDB (8.33 °CDB) / 43 °FWB (6.11 °CWB). – Pipe length: 25 ft (7.5 m), Height difference: 0 ft (0 m). (Between outdoor unit and indoor unit.) • Protective function might work when using it outside the operation range. • *1: Sound pressure level <ul style="list-style-type: none"> – Measured values in manufacturer's anechoic chamber. – Because of the surrounding sound environment, the sound levels measured in actual installation conditions might be higher than the specified values here. 					

2. Dimensions

2-1. Indoor unit

■ Model: ASUH18LMAS

Unit: in (mm)

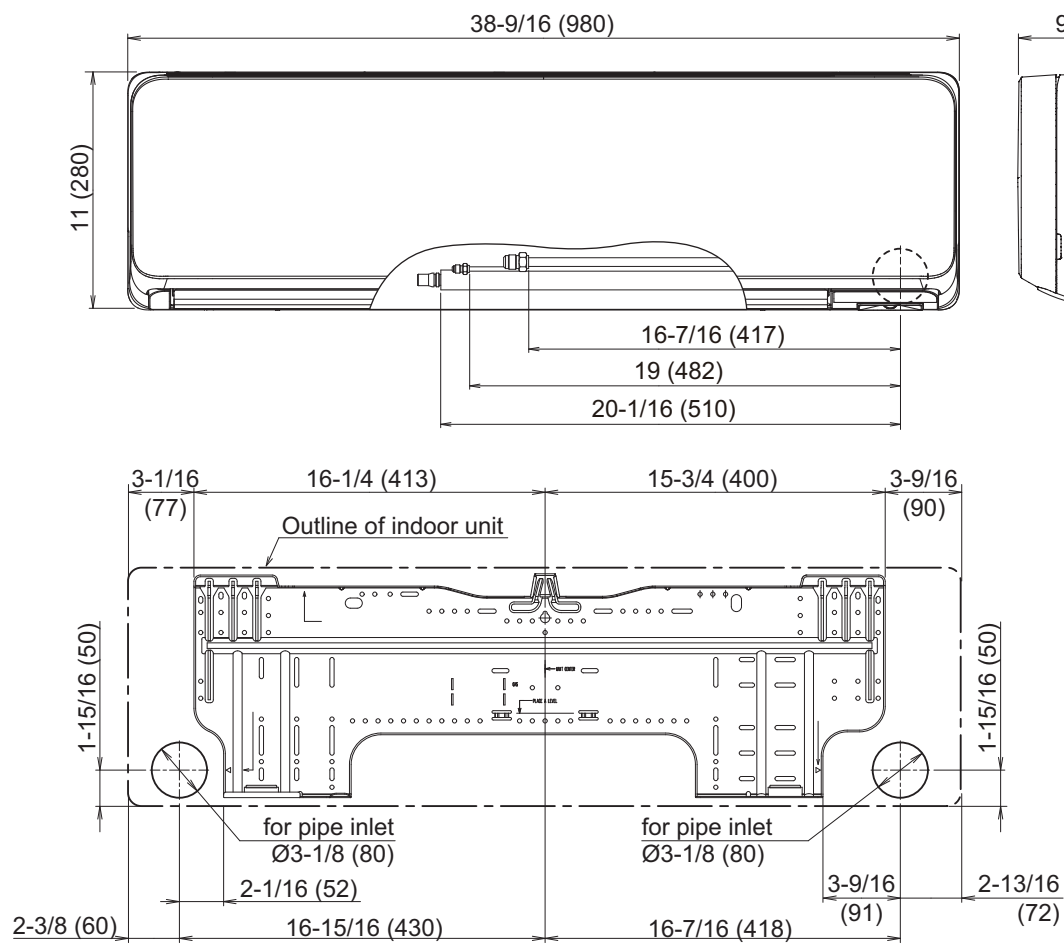

● Installation space requirement

Provide sufficient installation space for product safety.

⚠ CAUTION

Do not place any other electrical products or household belongings under the product. Condensation dripping from the product might get them wet, and may cause damage or malfunction to the property.

Unit: in (mm)

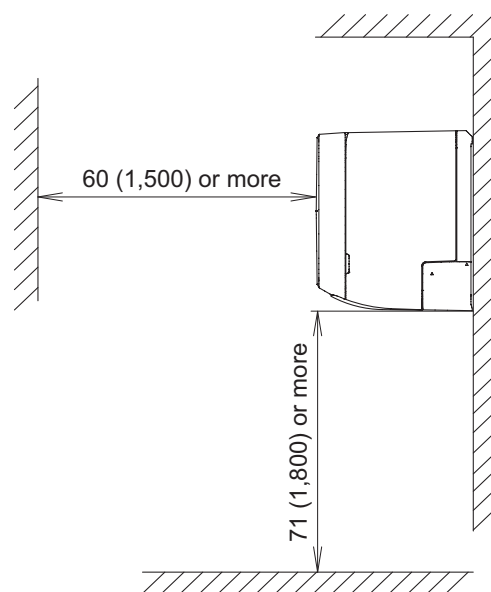
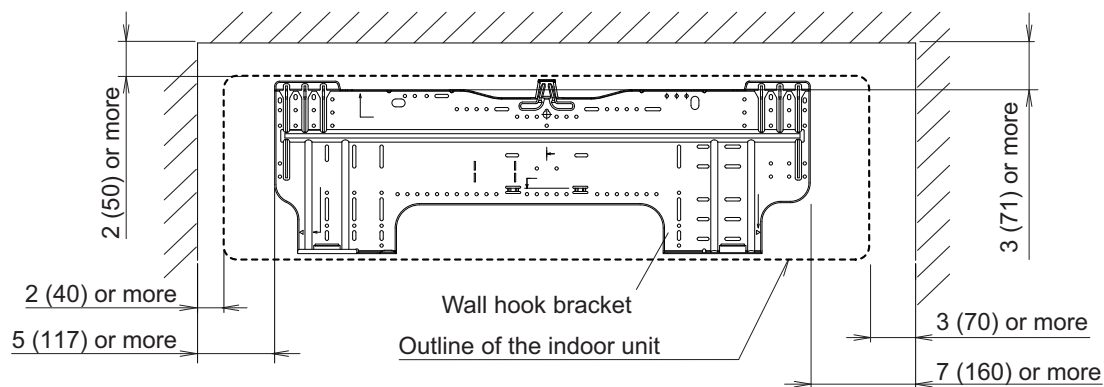

■ Model: ASUH24LMAS

Unit: in (mm)

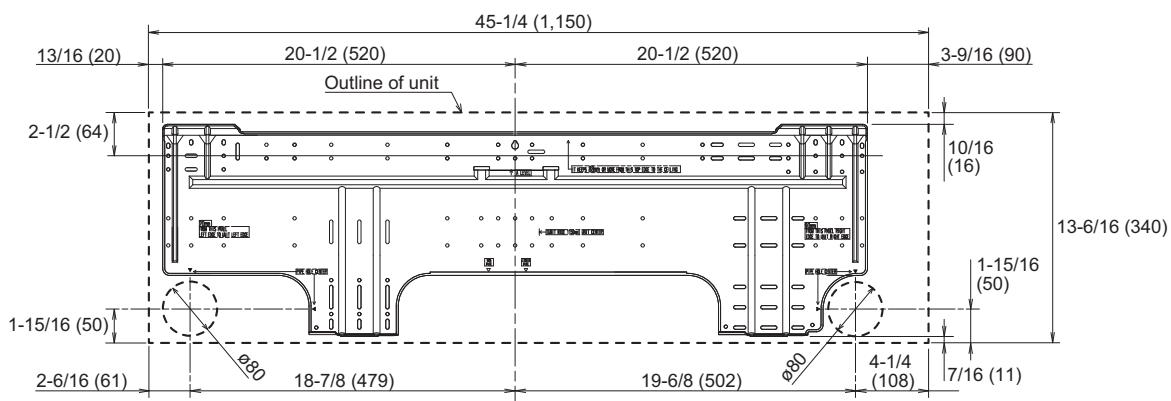
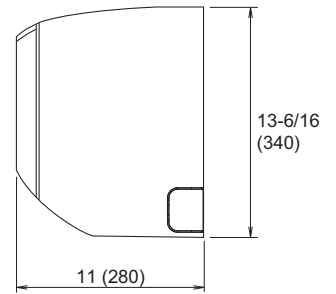
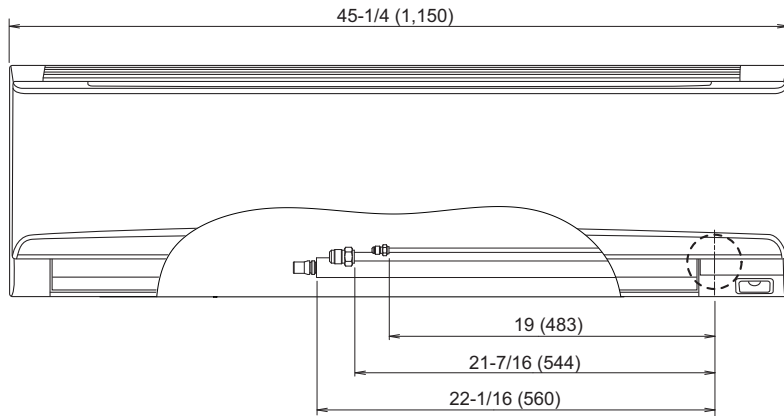

● Installation space requirement

Provide sufficient installation space for product safety.

⚠ CAUTION

Do not place any other electrical products or household belongings under the product. Condensation dripping from the product might get them wet, and may cause damage or malfunction to the property.

Unit: in (mm)

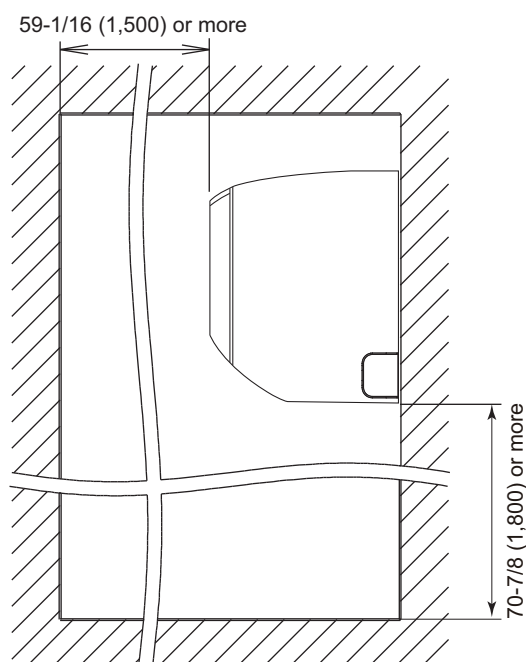
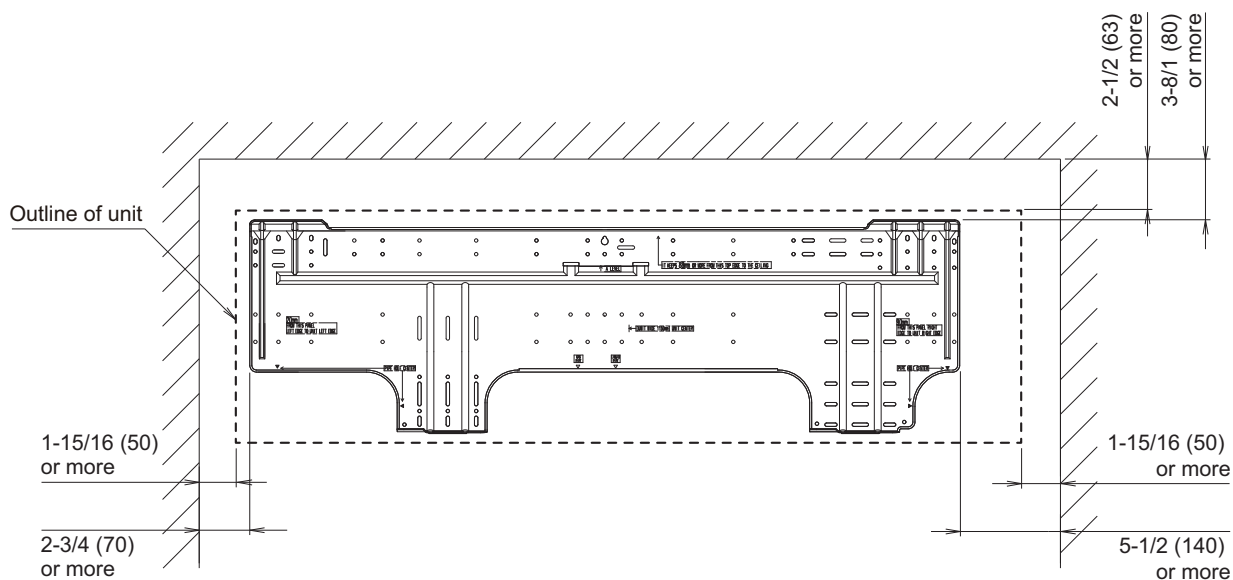

2-2. Outdoor unit

Models: AOUH18LMAS1 and AOUH24LMAS1

Unit: in (mm)

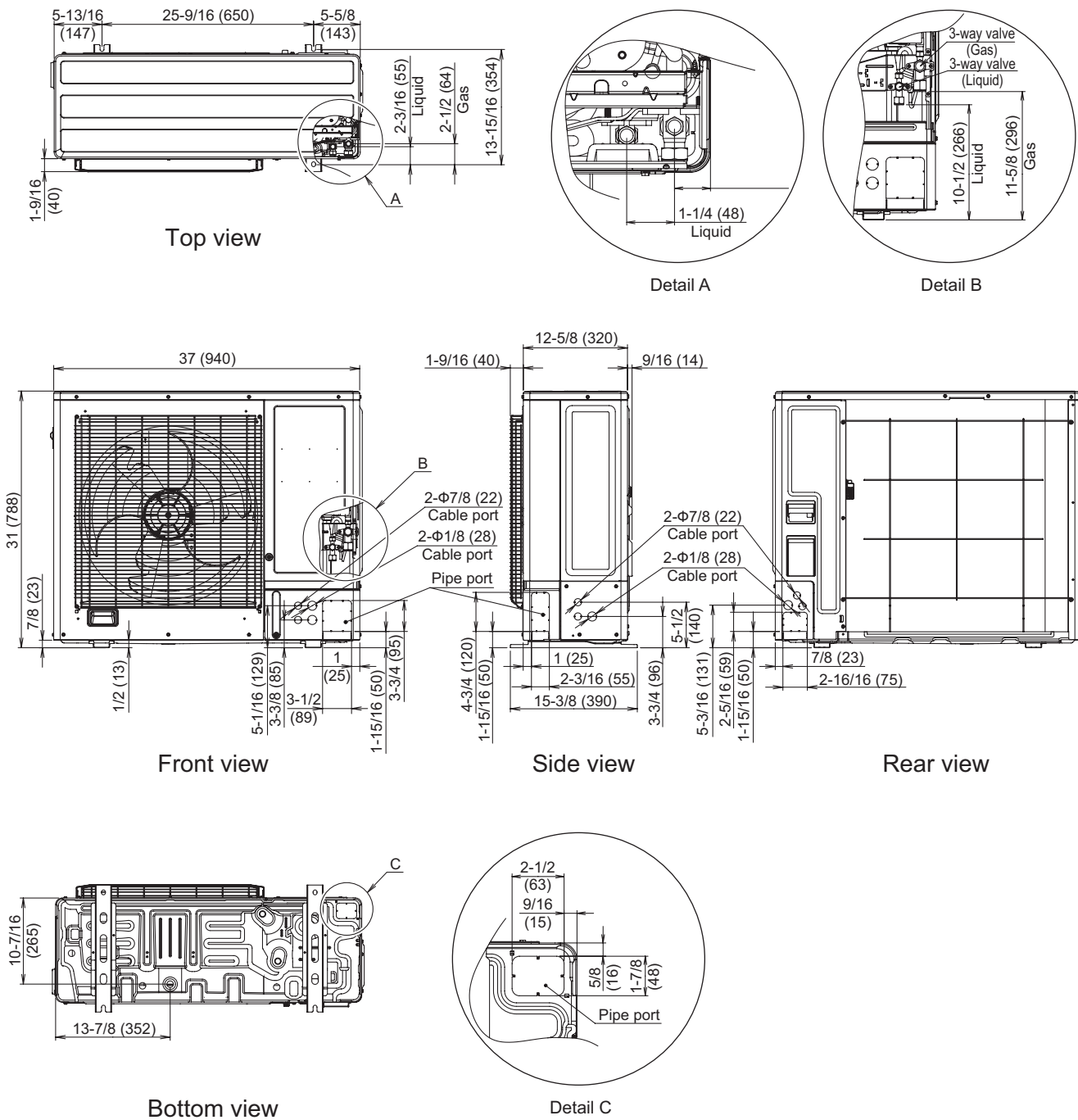

2. TECHNICAL DATA AND PARTS LIST

CONTENTS

2. TECHNICAL DATA AND PARTS LIST

1. Precautions	02-1
2. Indoor unit parts list	02-2
2-1. Model: ASUH18LMAS	02-2
2-2. Model: ASUH24LMAS	02-6
3. Outdoor unit parts list	02-10
3-1. Models: AOUH18LMAS1 and AOUH24LMAS1	02-10
4. Accessories	02-14
4-1. Indoor unit	02-14
4-2. Outdoor unit.....	02-16
5. Refrigerant system diagrams	02-17
5-1. Models: AOUH18LMAS1 and AOUH24LMAS1	02-17
6. Wiring diagrams	02-18
6-1. Indoor unit	02-18
6-2. Outdoor unit.....	02-19
7. PC board diagrams	02-20
7-1. Models: ASUH18LMAS and ASUH24LMAS.....	02-20
7-2. Models: AOUH18LMAS1 and AOUH24LMAS1	02-21

1. Precautions

When you start servicing, pay attention to the following points. For detailed precautions, refer to the installation manual of the products.

CAUTION

- Service personnel
 - Any person who is involved with working on or breaking into a refrigerant circuit should hold a current valid certificate from an industry-accredited assessment authority, which authorizes their competence to handle refrigerants safely in accordance with an industry recognized assessment specification.
 - Servicing shall only be performed as recommended by the equipment manufacturer. Maintenance and repair requiring the assistance of other skilled personnel shall be carried out under the supervision of the person competent in the use of flammable refrigerants.
 - Servicing shall be performed only as recommended by the manufacturer.
 - Work
 - Work in confined spaces shall be avoided.
 - The area around the workspace shall be sectioned off.
 - Electric shock may occur. After turning off the power, always wait 5 minutes before touching electrical components.
 - Do not touch the fins of the heat exchanger. Touching the heat exchanger fins could result in damage to the fins or personal injury such as skin rupture.
 - Do not place any other electrical products or household belongings under the product.
 - Condensation dripping from the product might get them wet, and may cause damage or malfunction to the property.
-
- Service parts information and design are subject to change without notice for product improvement.
 - For the latest information of the service parts, refer to our Service Portal.
<https://fujitsu-general.force.com/portal/>
 - Precise figure of the service parts listed in this manual may differ from the actual service parts.

2. Indoor unit parts list

2-1. Model: ASUH18LMAS

■ Exterior parts

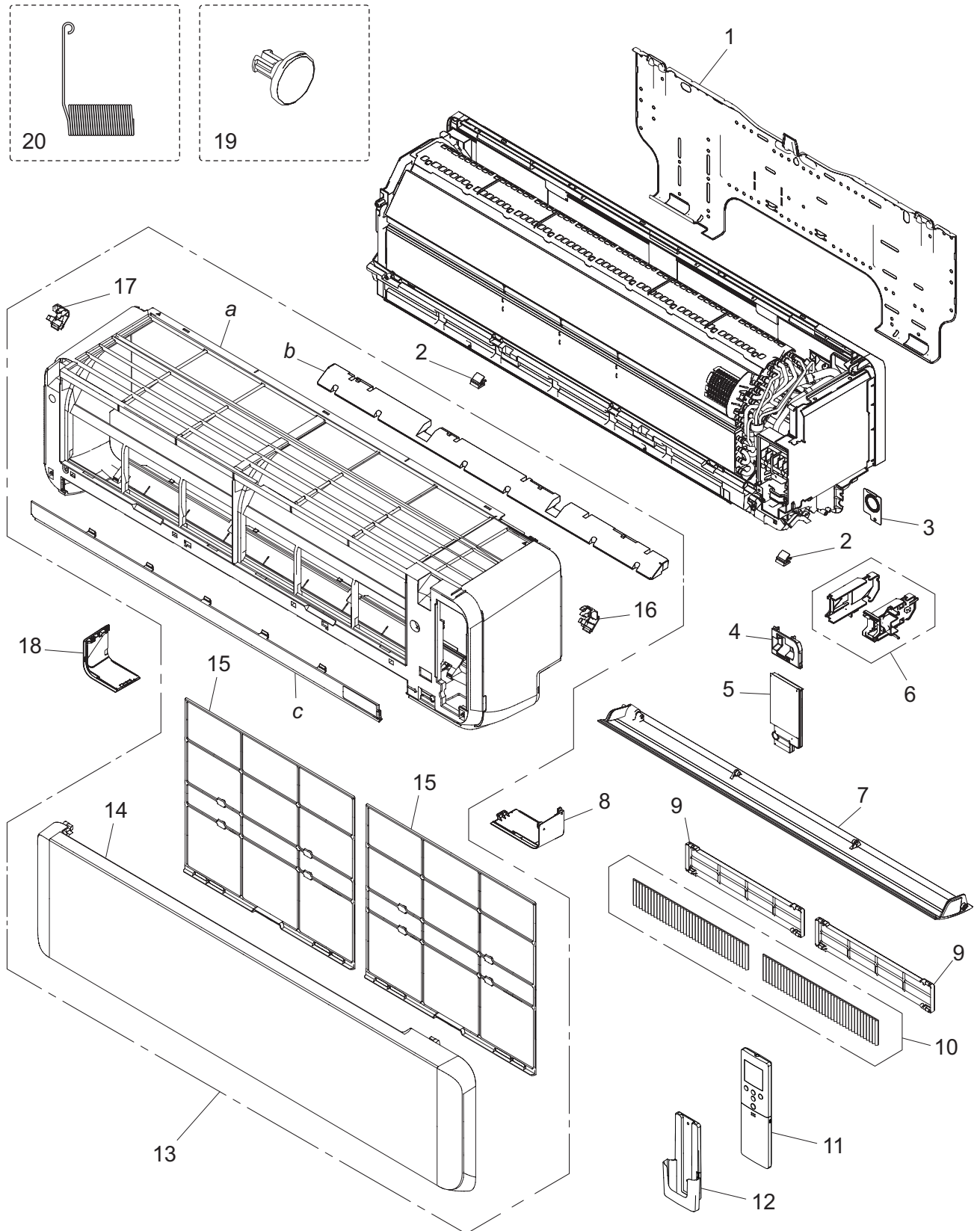

TECHNICAL DATA
AND PARTS LIST

TECHNICAL DATA
AND PARTS LIST

Item no.	Part no.	Part name	Service part
1	9388158013	Bracket panel	◆
2	9387476002	Screw cover	◆
3	9313951047	Conduit holder	◆
4	9383729027	Wire cover assy B	◆
5	9387597035	Wire cover assy	◆
6	9383765056	WLAN adapter holder assy	◆
7	9387479010	Louver assy (Up/Down)	◆
8	9323342033	Under cover R	◆
9	9332911008	Electric filter holder	◆
10	9317250009	Air cleaning filter assy	◆
11	9332438895	Wireless remote controller	◆
12	9318912005	Remote controller holder	◆
13	9384977007	Front panel total assy	◆
14	9387756210	Intake grille assy	◆
15	9323340008	Air filter	◆
16	9333719009	Grille clamper L	◆
17	9333704005	Grille clamper R	◆
18	9323341036	Under cover L	◆
19	9333608006	Bush	◆
20	9383730030	Louver spring	◆
<i>a</i>	—	Front panel	—
<i>b</i>	—	Panel cover	—
<i>c</i>	—	Front panel B	—

■ Chassis

TECHNICAL DATA
AND PARTS LIST

TECHNICAL DATA
AND PARTS LIST

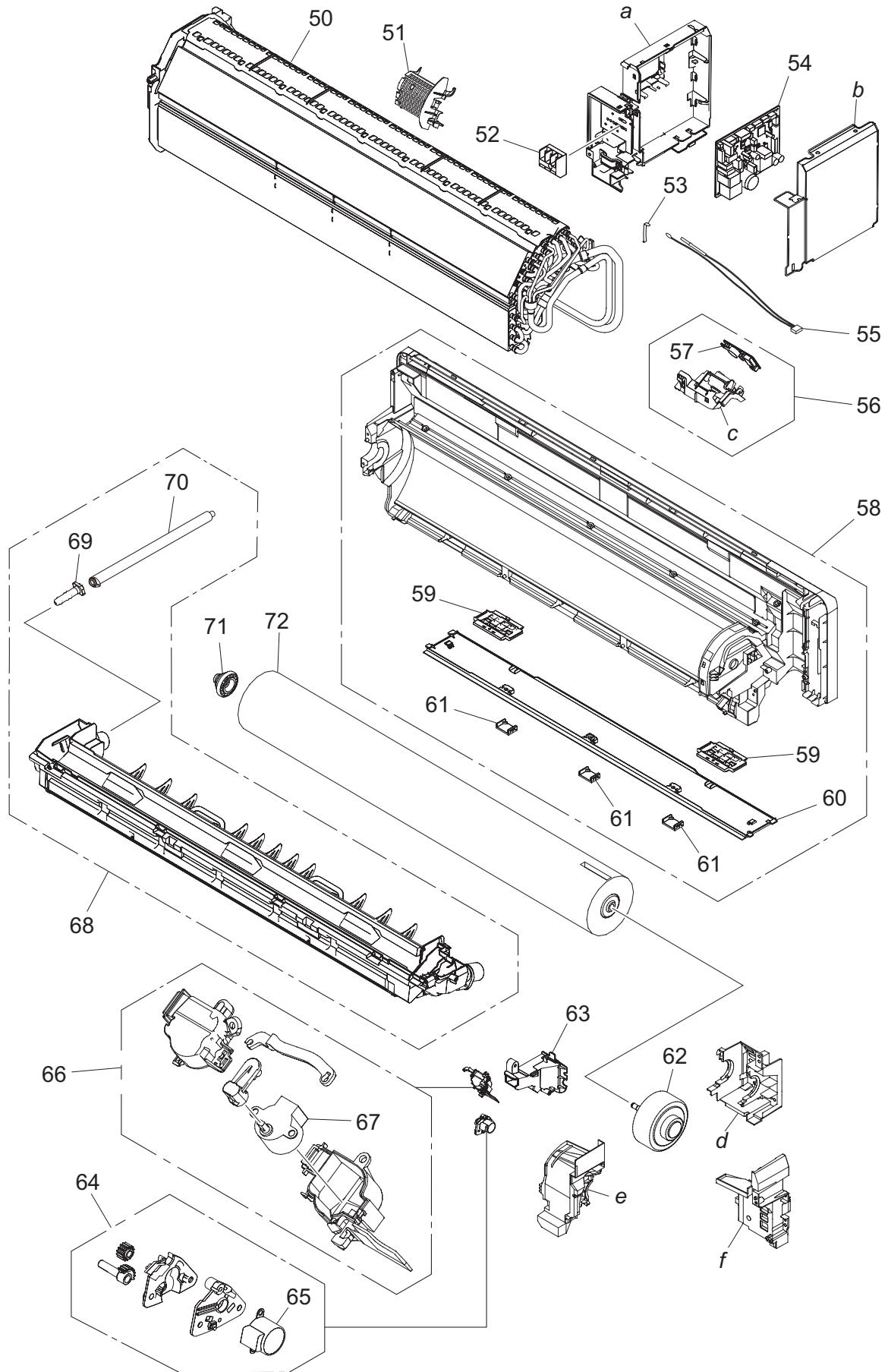

Item no.	Part no.	Part name	Service part
50	9383735158	Evaporator total assy	◆
51	9387467000	Room thermistor holder	◆
52	9901013010	Terminal 3P	◆
53	9316577008	Thermistor spring B	◆
54	9711732026	Main PCB	◆
55	9900627041	Thermistor assy	◆
56	9711146052	Display assy	◆
57	9711147011	Indicator PCB	◆
58	9387587173	Base assy	◆
59	9388150000	Pipe bracket A	◆
60	9388155005	Under cover C	◆
61	9388182001	Screw cover	◆
62	9603821005	DC fan motor	◆
63	9387488043	Cable guide	◆
64	9387714012	Gear case assy	◆
65	9901011016	Stepping motor	◆
66	9383728006	R and L louver SPM assy	◆
67	9901011023	Stepping motor	◆
68	9387590142	Drain pan total assy	◆
69	9316177017	Drain cap	◆
70	9316904002	Drain hose assy	◆
71	9333628004	Bearing D assy	◆
72	9387055054	Crossflow fan assy	◆
—	9901010071	Wire with connector (CN75 on Main PCB—WLAN adapter [option])	◆
<i>a</i>	—	Control box	—
<i>b</i>	—	Control cover	—
<i>c</i>	—	Display case	—
<i>d</i>	—	Motor case	—
<i>e</i>	—	Motor cover assy	—
<i>f</i>	—	Pipe bracket	—

2-2. Model: ASUH24LMAS

■ Exterior parts

TECHNICAL DATA
AND PARTS LIST

TECHNICAL DATA
AND PARTS LIST

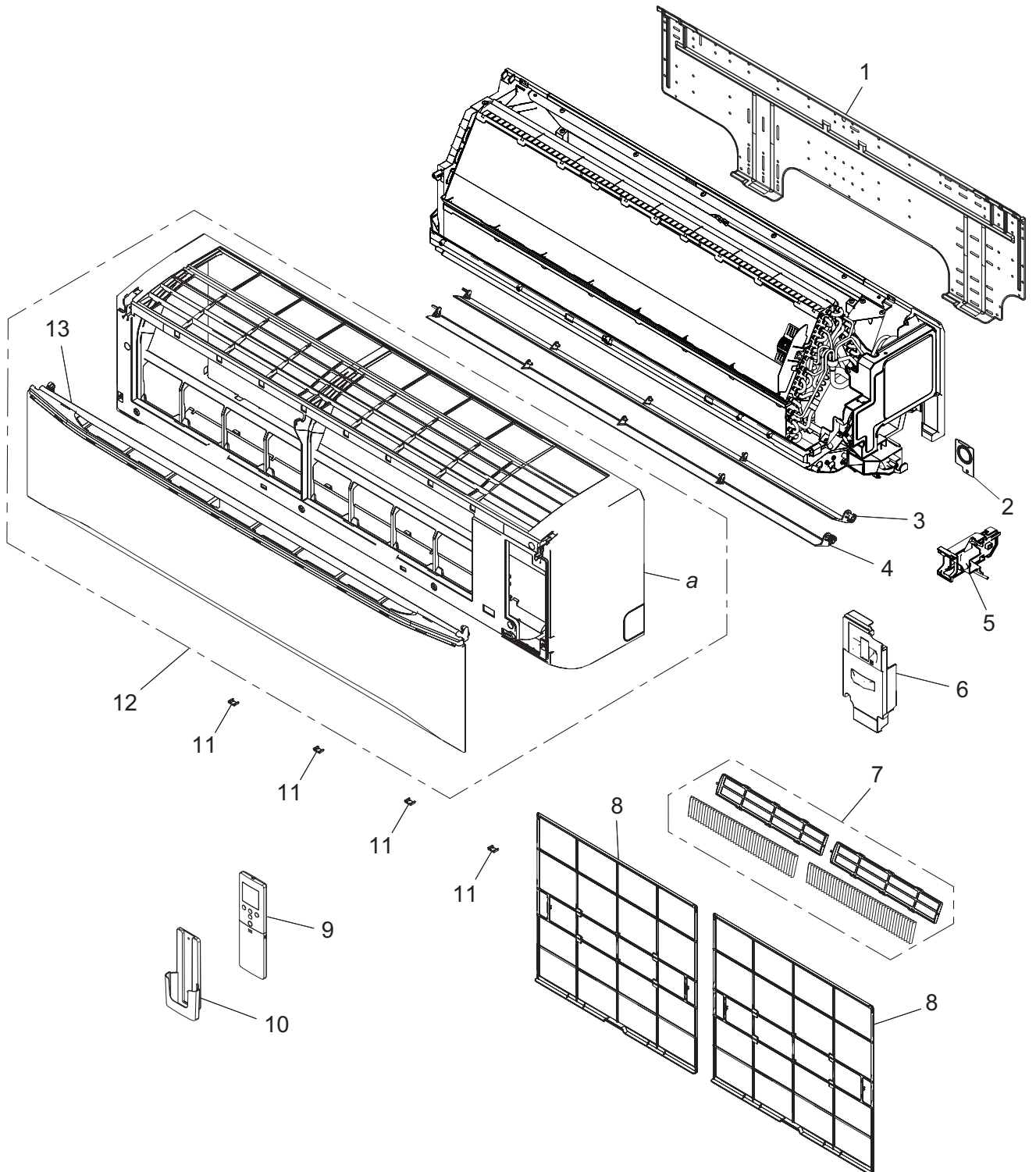

Item no.	Part no.	Part name	Service part
1	9386990004	Bracket panel	◆
2	9313951047	Conduit holder	◆
3	9386958004	Louver U	◆
4	9386959001	Louver Z	◆
5	9383765063	WLAN adapter holder assy	◆
6	9387074017	Wire cover assy	◆
7	9315212016	Air clean filter assy	◆
8	9386960007	Air filter	◆
9	9332438895	Wireless remote controller	◆
10	9318912005	Remote controller holder	◆
11	9386986007	Screw cover	◆
12	9387072211	Front panel total assy	◆
13	9382114039	Intake grille assy	◆
a	—	Front panel	—

■ Chassis

TECHNICAL DATA
AND PARTS LIST

TECHNICAL DATA
AND PARTS LIST

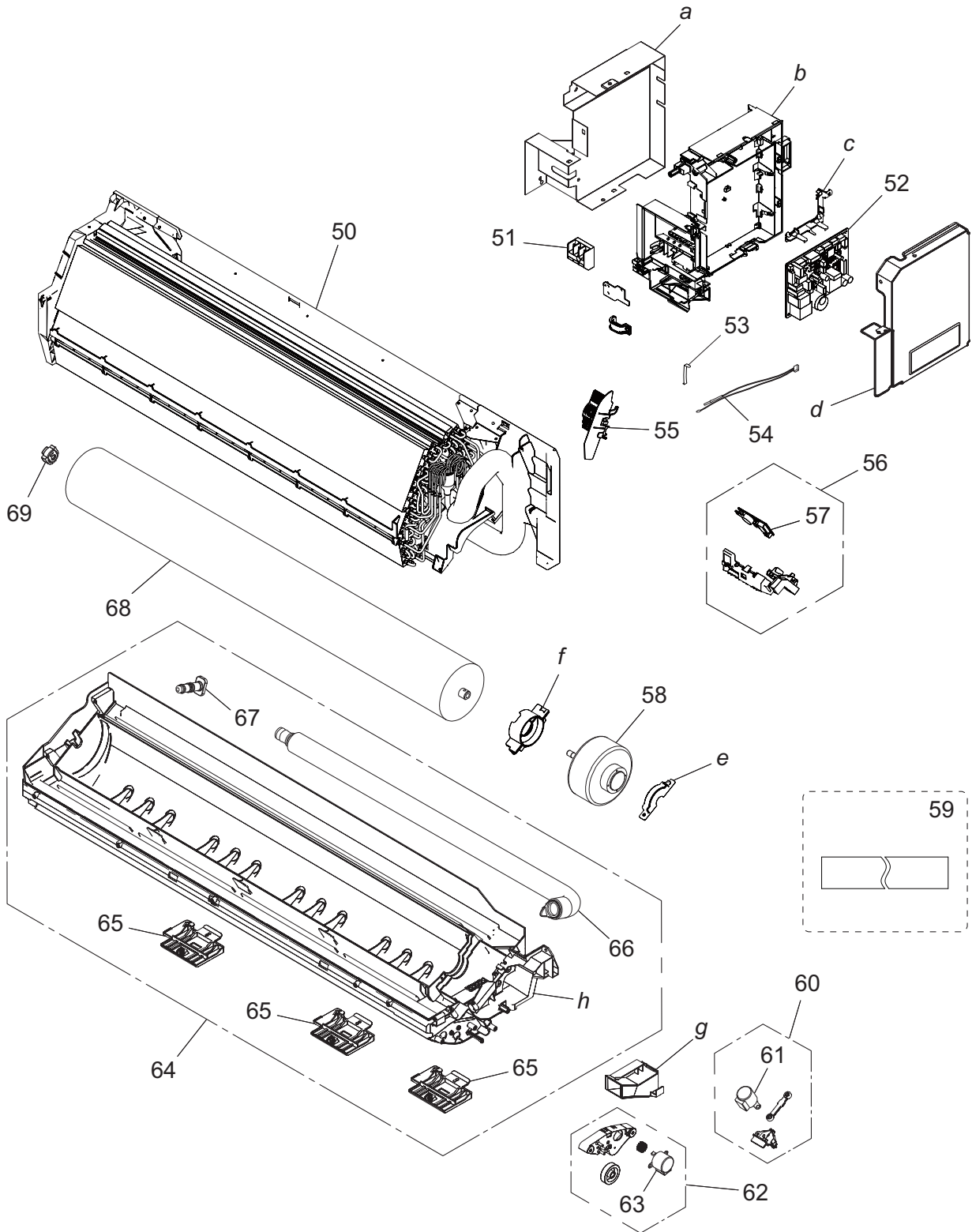

Item no.	Part no.	Part name	Service part
50	9387064155	Evaporator total assy	◆
51	9901013010	Terminal	◆
52	9711732033	Main PCB	◆
53	9316577008	Thermistor spring B	◆
54	9900627027	Thermistor assy	◆
55	9386988001	Room thermistor holder	◆
56	9711146090	Display assy	◆
57	9711147035	Indicator PCB	◆
58	9603933005	DC fan motor	◆
59	9361756007	Drain hose insulation T	◆
60	9387063004	Link holder assy	◆
61	9900139186	Step motor	◆
62	9387062007	Gear cover assy	◆
63	9900384234	Step motor	◆
64	9387060034	Casing assy	◆
65	9318743012	Pipe bracket	◆
66	9388540009	Drain hose assy	◆
67	9316177017	Drain cap	◆
68	9387055009	Crossflow fan assy	◆
69	9306628017	Bearing C assy	◆
<i>a</i>	—	Box shield assy	—
<i>b</i>	—	Control box	—
<i>c</i>	—	PCB holder A	—
<i>d</i>	—	Control cover	—
<i>e</i>	—	Motor cover	—
<i>f</i>	—	Motor cover	—
<i>g</i>	—	Cable guide	—
<i>h</i>	—	Casing	—

3. Outdoor unit parts list

3-1. Models: AOUH18LMAS1 and AOUH24LMAS1

■ Exterior parts and chassis

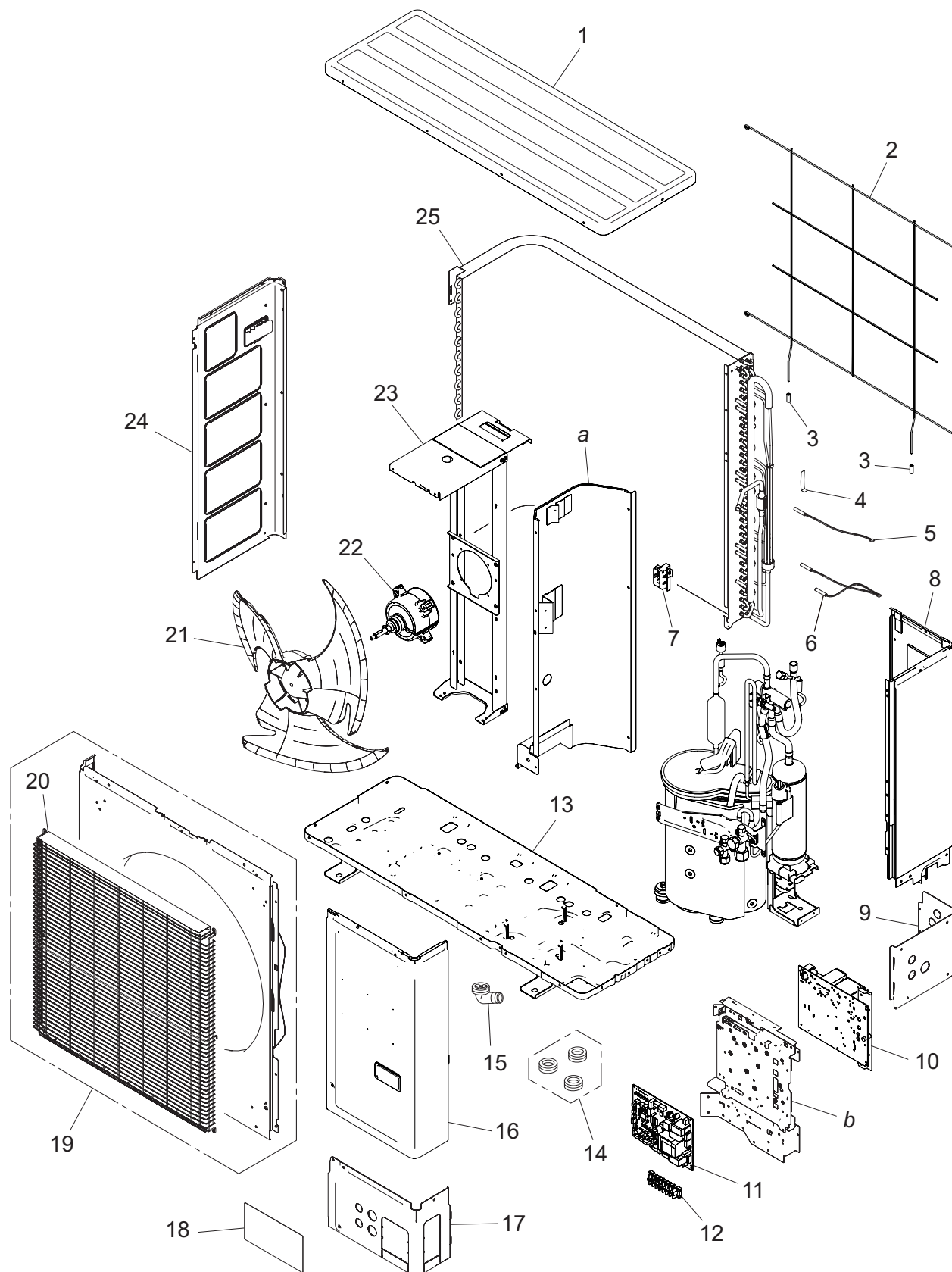

TECHNICAL DATA
AND PARTS LIST

TECHNICAL DATA
AND PARTS LIST

Item no.	Part no.	Part name	Service part
1	9383880001	Top panel assy	◆
2	9383779008	Protective net	◆
3	9375361013	Net rubber	◆
4	313728262708	Thermistor spring A	◆
5	9900984038	Thermistor (Heat exchanger temp.)	◆
6	9900727154	Thermistor assy (Evaporator and Compressor temp.)	◆
7	9383607004	Thermo holder	◆
8	9383874000	Right panel sub assy	◆
9	9384997005	Rear pipe cover	◆
10	9709686317	Inverter PCB	◆
11	9711431578	Main PCB (18 model)	◆
	9711431585	Main PCB (24 model)	◆
12	9900203085	Terminal	◆
13	9383871016	Base assy	◆
14	313166024302	Drain cap	◆
15	9303029015	Drain assy	◆
16	9383876004	Service panel sub assy	◆
17	9384196019	Front pipe cover	◆
18	9380114000	Emblem rear	◆
19	9383863035	Front panel assy	◆
20	9350680009	Fan guard assy	◆
21	9383336003	Propeller fan	◆
22	9603732011	DC fan motor	◆
23	9383862007	Motor bracket assy	◆
24	9383882005	Left panel sub assy	◆
25	9374420711	Condenser sub assy	◆
—	9711198006	Wire with connector (P108 on Main PCB—Terminal)	◆
—	9711203038	Wire with connector (P660 on Main PCB—P662 on Inverter PCB)	◆
—	9711204004	Wire with connector (P661 on Main PCB—P663 on Inverter PCB)	◆
—	9711205001	Wire with connector (P350 on Main PCB—P351 on Inverter PCB)	◆
—	9711212009	Wire with connector (P650 on Inverter PCB—DC fan motor)	◆
—	9711213006	Wire with connector (P770 on Inverter PCB)	◆
—	9711214003	Wire with connector (Pressure switch)	◆
<i>a</i>	—	Separate wall assy	—
<i>b</i>	—	Control box unit	—

Compressor

TECHNICAL DATA
AND PARTS LIST

TECHNICAL DATA
AND PARTS LIST

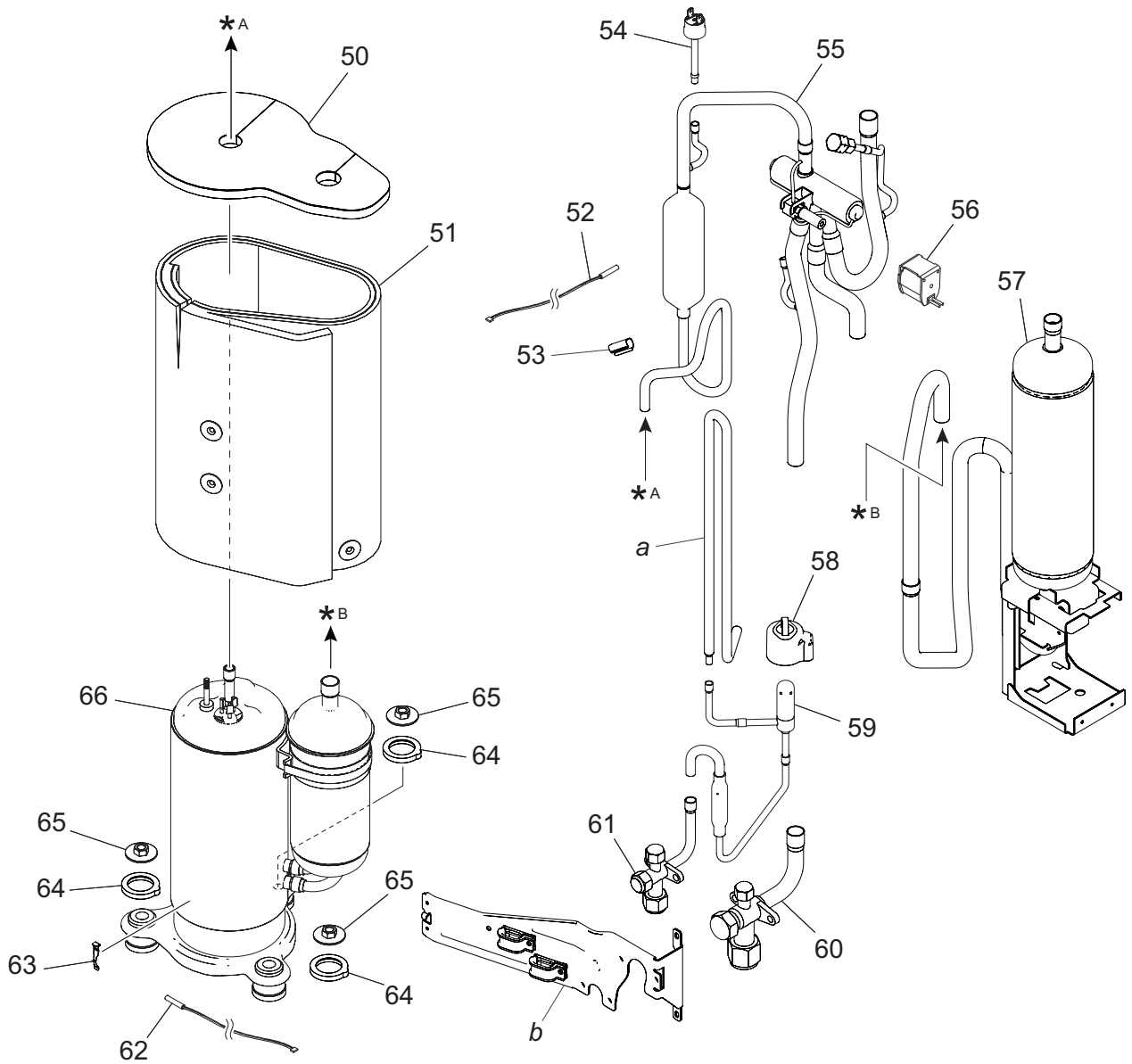







Item no.	Part no.	Part name	Service part
50	9380516064	Sound insulator (Top)	◆
51	9379647243	Sound insulator (Body)	◆
52	9900565091	Thermistor (Outdoor temp.)	◆
53	9357804002	Thermostat holder	◆
54	9900186029	Pressure switch	◆
55	9374425723	4-way valve assy	◆
56	9970194016	Solenoid	◆
57	9383855115	Refrigerant volume adjustment unit	◆
58	9970209000	Expansion valve coil	◆
59	9370947328	Expansion valve assy	◆
60	9379079013	3-way valve assy	◆
61	9377958037	3-way valve assy	◆
62	9900985035	Thermistor (Compressor temp.)	◆
63	9810028006	Thermistor stopper	◆
64	9379179096	Rubber washer G	◆
65	9377973016	Special nut	◆
66	9810666000	Compressor assy	◆
<i>a</i>	—	Joint pipe D	—
<i>b</i>	—	Wiring fixation unit	—

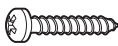

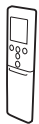

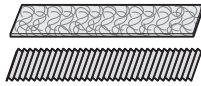
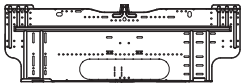

4. Accessories

4-1. Indoor unit

■ Model: ASUH18LMAS

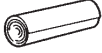
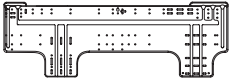
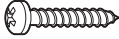

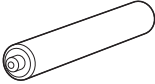
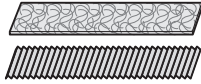
Part name	Exterior	Q'ty	Part name	Exterior	Q'ty
Operating manual		1	Tapping screw (large)		5
Installation manual		1	Tapping screw (small)		2
Remote controller		1	Battery		2
Remote controller holder		1	Filter holder		2
Cloth tape		1	Air cleaning filters		1
Wall hook bracket		1			

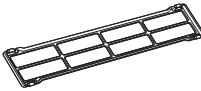
Model: ASUH24LMAS

Part name	Exterior	Q'ty	Part name	Exterior	Q'ty
Operating manual		1	Drain hose insulation		1
Installation manual		1	Cloth tape		1
Wall hook bracket		1	Tapping screw (large)		8
Remote controller		1	Tapping screw (small)		2
Battery		2	Air cleaning filters		1
Remote controller holder		1	Filter holder		2

4-2. Outdoor unit

■ Models: AOUE18LMA51 and AOUE24LMA51

Part name	Exterior	Q'ty	Part name	Exterior	Q'ty
Installation manual		1	Drain cap		3
Drain pipe		1			

5. Refrigerant system diagrams

5-1. Models: AOUH18LMAS1 and AOUH24LMAS1

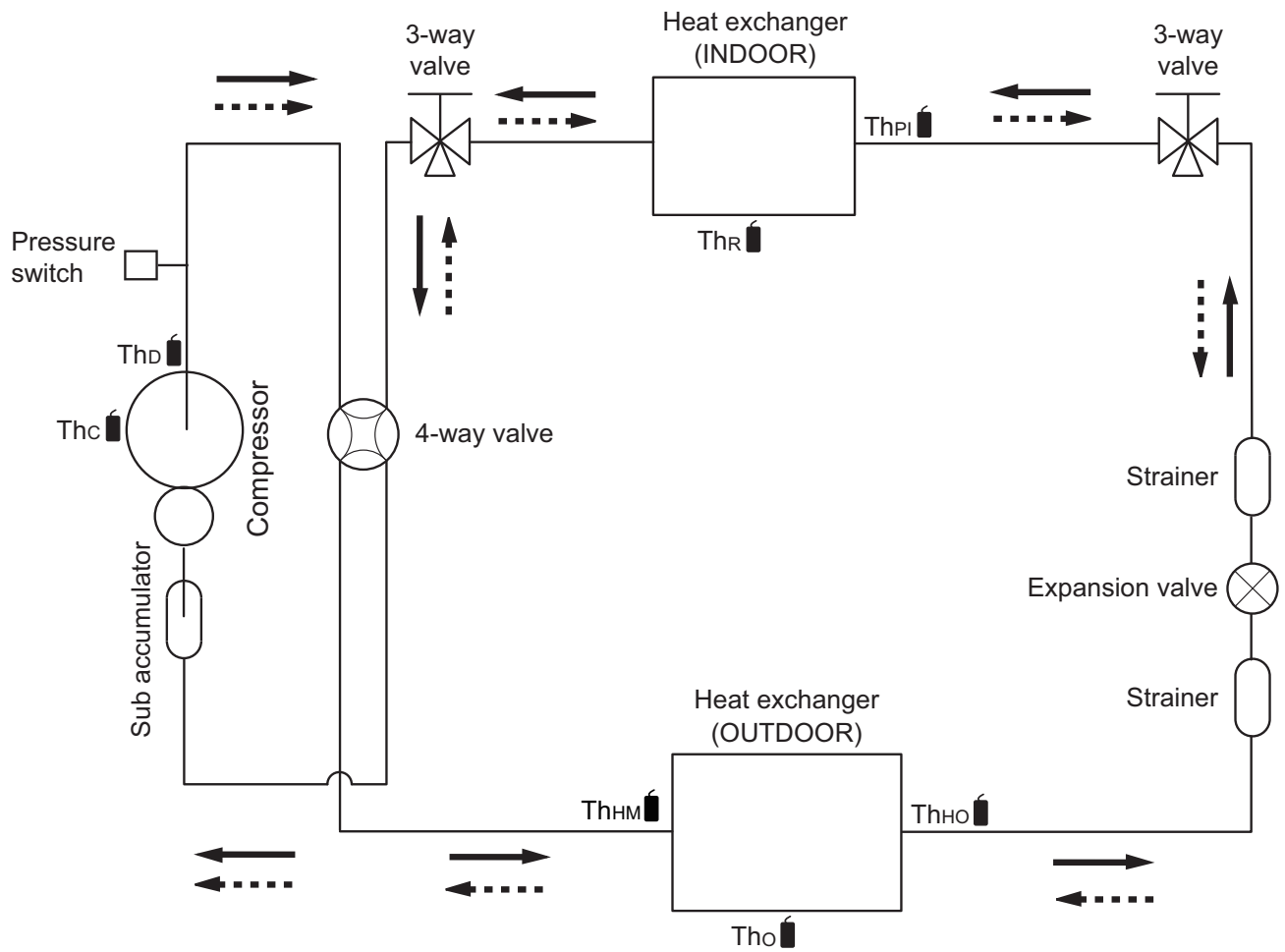

———→ : Cooling
 - - - - -→ : Heating

- Th_c : Thermistor (Compressor temperature)
- Th_d : Thermistor (Discharge temperature)
- Th_m : Thermistor (Heat exchanger middle temperature)
- Th_o : Thermistor (Outdoor temperature)
- Th_o : Thermistor (Heat exchanger out temperature)
- Th_{pi} : Thermistor (Pipe temperature)
- Th_r : Thermistor (Room temperature)

TECHNICAL DATA AND PARTS LIST

TECHNICAL DATA AND PARTS LIST

6. Wiring diagrams

6-1. Indoor unit

Models: ASUH18LMAS and ASUH24LMAS

TECHNICAL DATA AND PARTS LIST

TECHNICAL DATA AND PARTS LIST

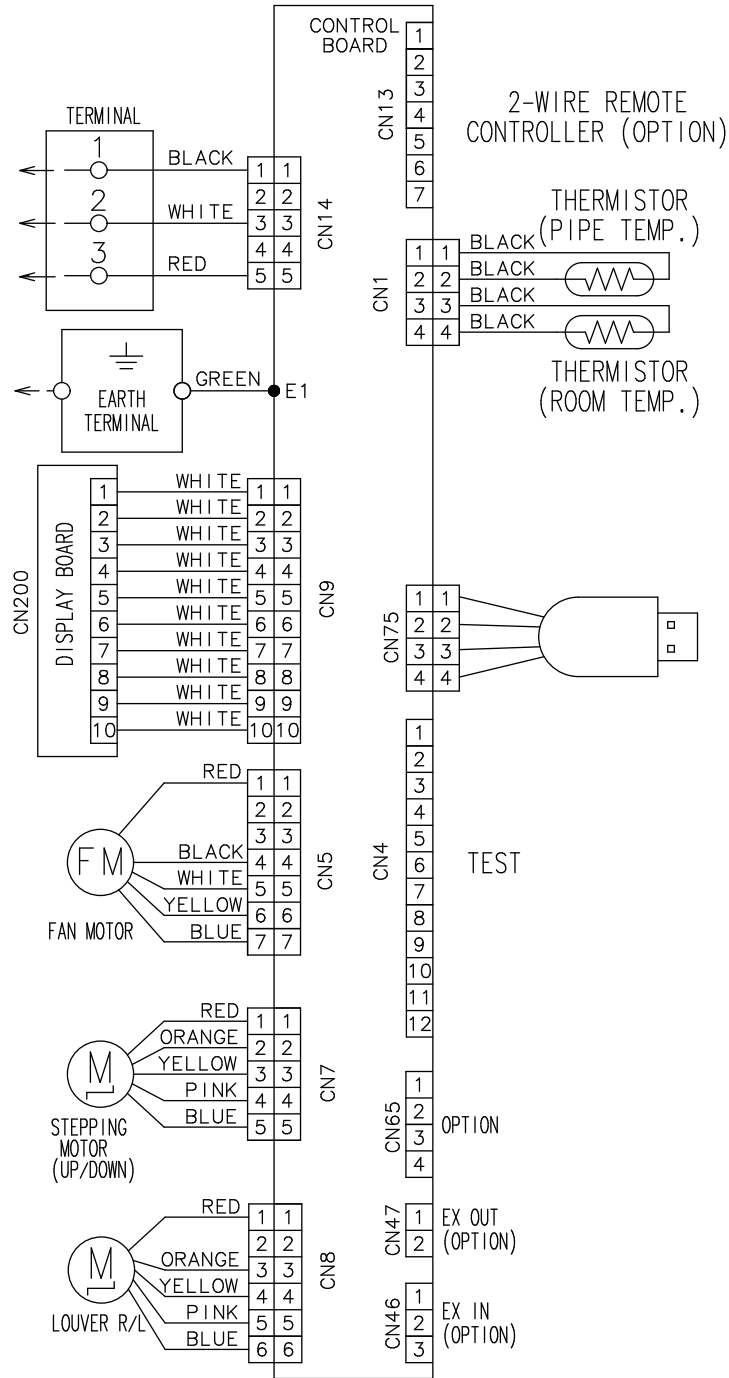

6-2. Outdoor unit

Models: AOUH18LMA51 and AOUH24LMA51

TECHNICAL DATA AND PARTS LIST

TECHNICAL DATA AND PARTS LIST

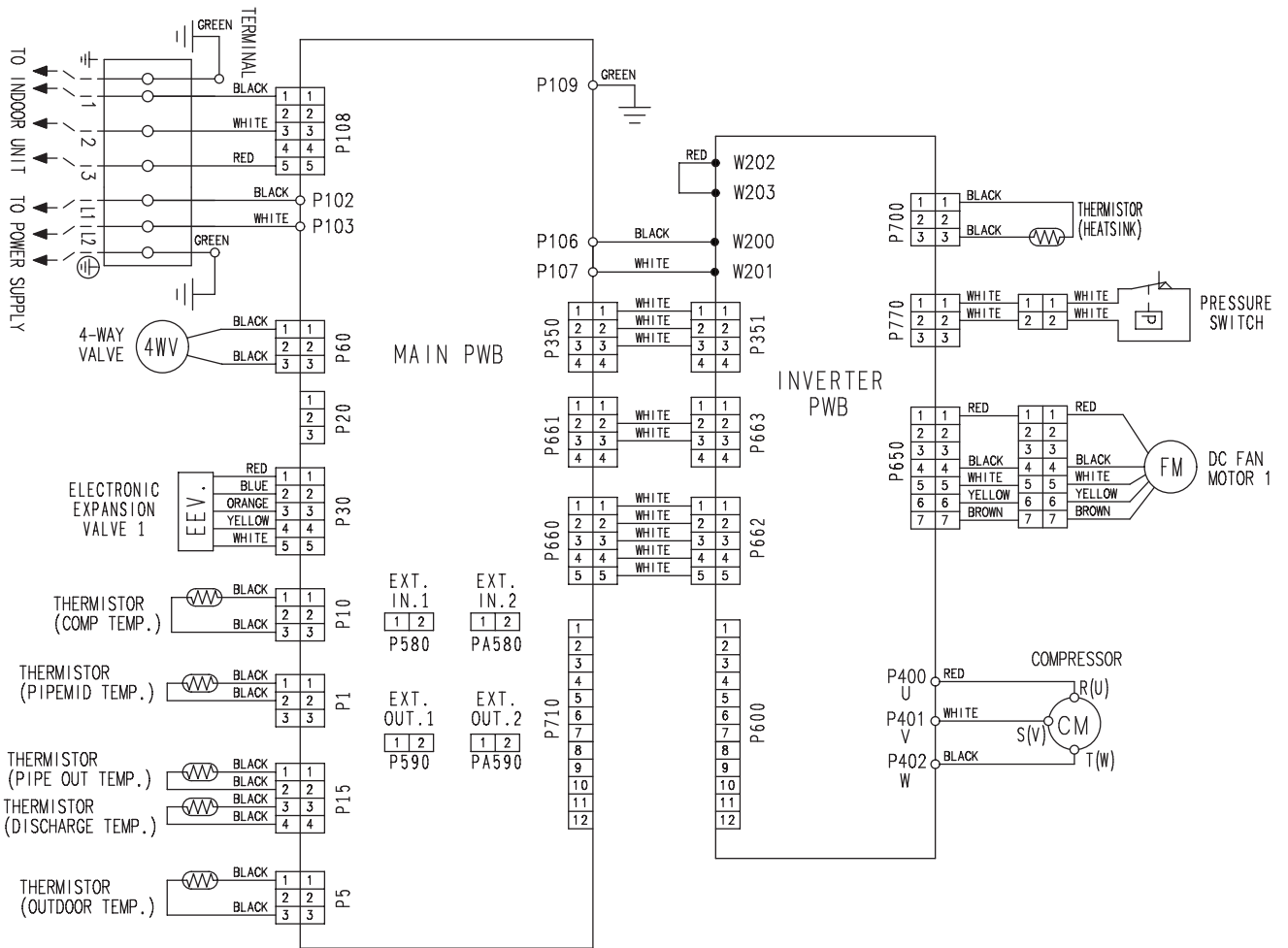

7. PC board diagrams

7-1. Models: ASUH18LMAS and ASUH24LMAS

TECHNICAL DATA AND PARTS LIST

TECHNICAL DATA AND PARTS LIST

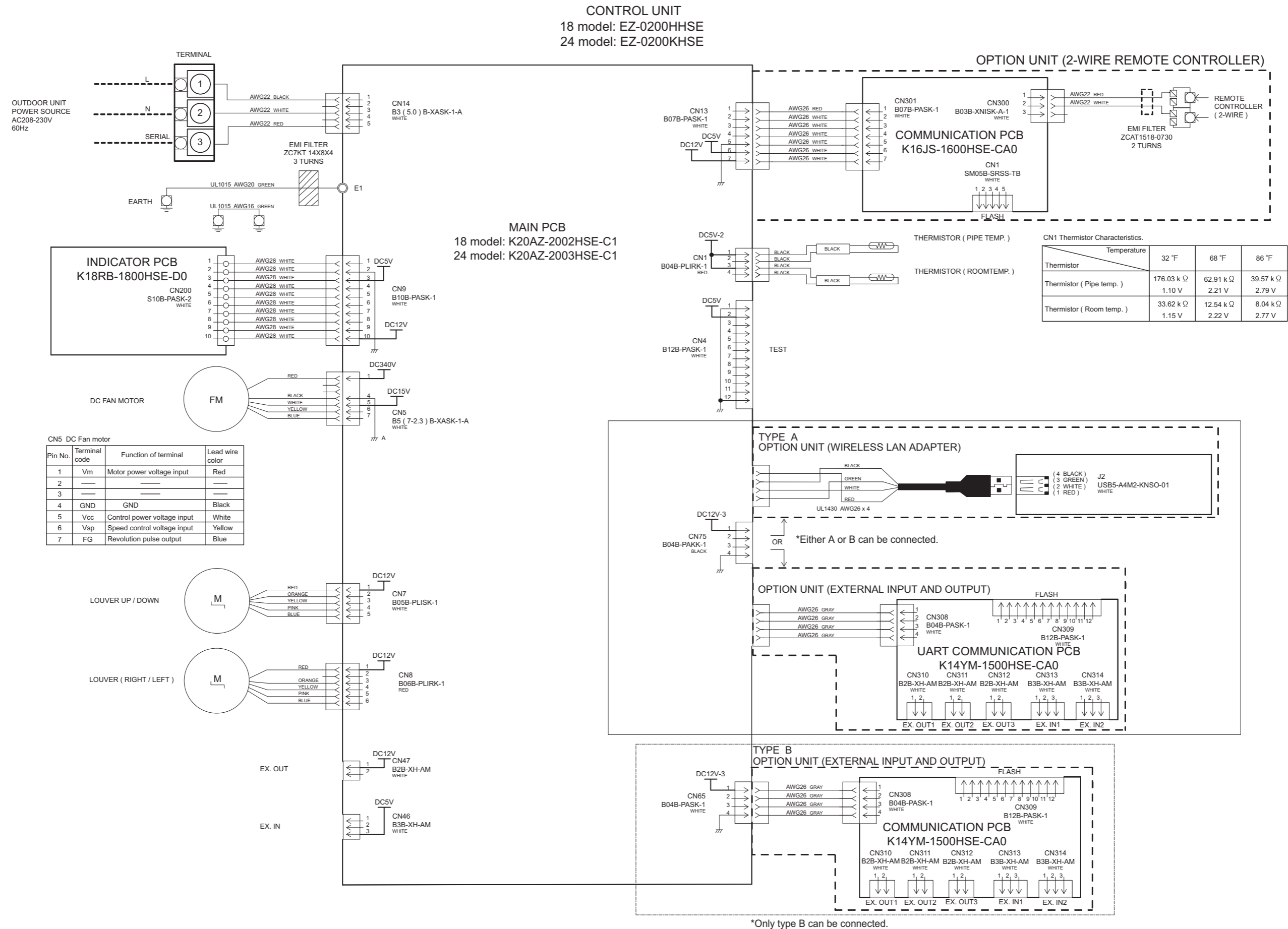

7-2. Models: AOUH18LMAS1 and AOUH24LMAS1

INVERTER ASSEMBLY
 18 model : EZ-02010HUE
 24 model : EZ-02010HUE

P700 Thermistor Characteristics.

Thermistor	Temperature	32 °F	68 °F	86 °F
Thermistor (Heatsink temp.)		15.83 k Ω	5.90 k Ω	3.78 k Ω
		0.43 V	1.01 V	1.42 V

TECHNICAL DATA AND PARTS LIST

TECHNICAL DATA AND PARTS LIST

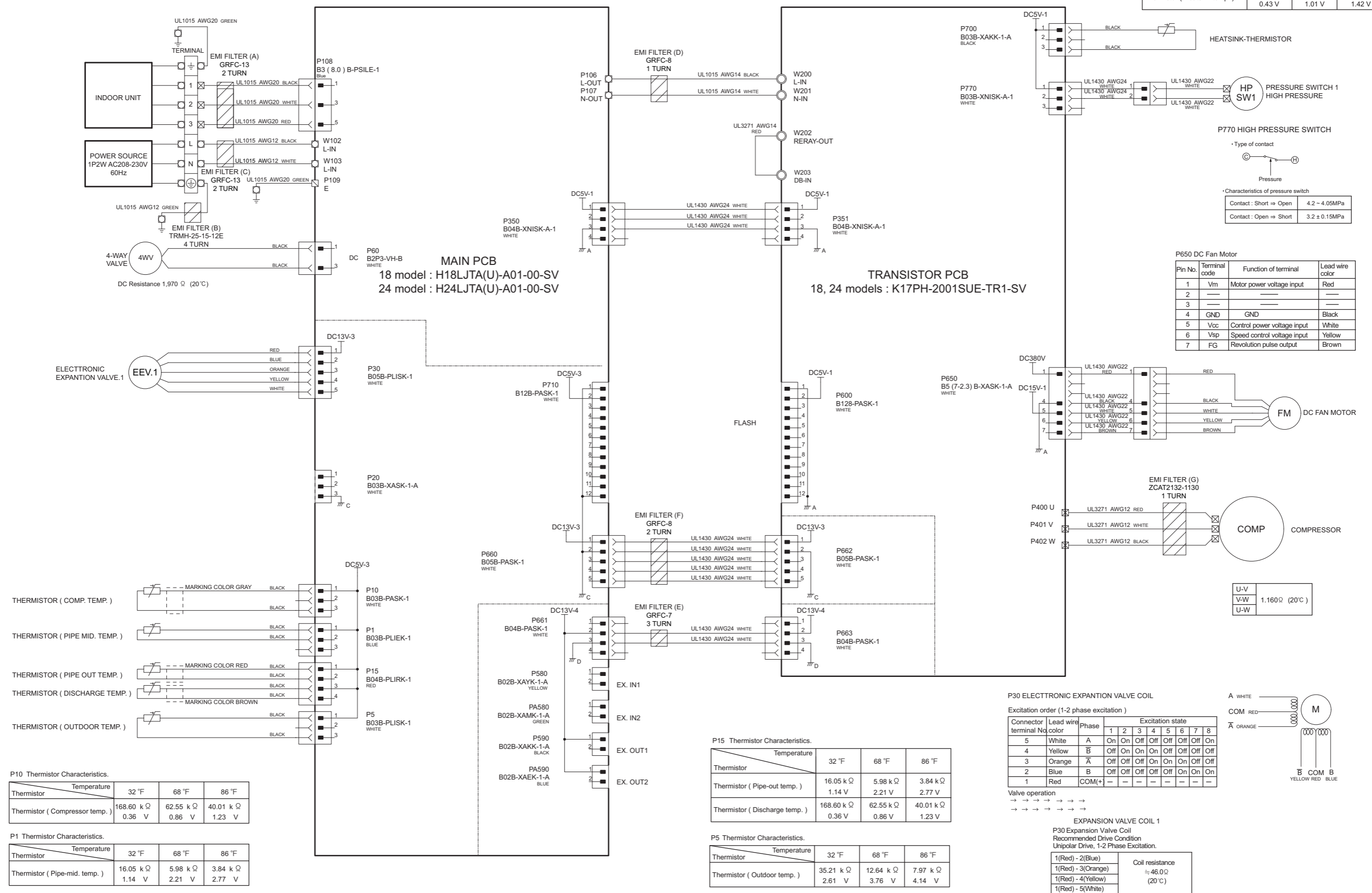

3. TROUBLESHOOTING

CONTENTS

3. TROUBLESHOOTING

1. Error code	03-1
1-1. How to check the error memory.....	03-1
1-2. How to erase the error memory	03-1
1-3. Error code table (Indoor unit and wired remote controller).....	03-2
1-4. Error code table (Outdoor unit).....	03-4
1-5. Error code table (Wireless LAN indicator).....	03-6
1-6. Error code table (Mobile App).....	03-7
1-7. Error message for wireless LAN control (Mobile App)	03-9
2. Troubleshooting with error code	03-13
2-1. E: 11.X. Serial communication error (Serial reverse transfer error) (Outdoor unit)	03-13
2-2. E: 11.X. Serial communication error (Serial forward transfer error) (Indoor unit)	03-15
2-3. E: 12.X. Wired remote controller communication error (Indoor unit)	03-17
2-4. E: 18.X. External communication error (Indoor unit)	03-18
2-5. E: 23.X. Combination error (Outdoor unit)	03-19
2-6. E: 26.X. Address setting error in wired remote controller (Indoor unit)	03-20
2-7. E: 29.X. Connected unit number error (Indoor unit)	03-21
2-8. E: 32.X. Indoor unit main PCB error (Indoor unit)	03-22
2-9. E: 35.X. MANUAL AUTO button error (Indoor unit)	03-23
2-10. E: 3A.X. Indoor unit communication circuit error (Indoor unit).....	03-24
2-11. E: 41.X. Room temperature sensor error (Indoor unit).....	03-26
2-12. E: 42.X. Indoor unit heat exchanger sensor error (Indoor unit)	03-27
2-13. E: 51.X. Indoor unit fan motor error (Indoor unit)	03-28
2-14. E: 58.X. Intake grille error (Indoor unit).....	03-29
2-15. E: 62.X. Outdoor unit main PCB error (Outdoor unit).....	03-30
2-16. E: 63.X. Inverter error (Outdoor unit)	03-31
2-17. E: 64.X. PFC circuit error (Outdoor unit).....	03-32
2-18. E: 65.X. Trip terminal L error (Outdoor unit)	03-33
2-19. E: 71.X. Discharge thermistor error (Outdoor unit)	03-34
2-20. E: 73.X. Heat exchanger (Middle/Outlet) temperature thermistor error (Outdoor unit).....	03-35
2-21. E: 74.X. Outdoor temperature thermistor error (Outdoor unit)	03-36
2-22. E: 77.X. Heat sink thermistor error (Outdoor unit)	03-37
2-23. E: 84.X. Current sensor error (Outdoor unit).....	03-38
2-24. E: 86.X. High pressure switch error (Outdoor unit)	03-39
2-25. E: 86.X. Pressure sensor error (Outdoor unit)	03-40
2-26. E: 94.X. Trip detection (Outdoor unit)	03-41
2-27. E: 95.X. Compressor motor control error (Outdoor unit)	03-42
2-28. E: 97.X. Outdoor unit fan motor error (Outdoor unit).....	03-43
2-29. E: 99.X. 4-way valve error (Outdoor unit)	03-45
2-30. E: A1.X. Discharge temperature error (Outdoor unit).....	03-47
2-31. E: A5.X. Low pressure error (Outdoor unit)	03-49
2-32. E: AC.X. Heat sink temperature error (Outdoor unit)	03-51

CONTENTS (continued)

3. Troubleshooting without error code.....	03-52
3-1. Indoor unit—No power.....	03-52
3-2. Outdoor unit—No power.....	03-53
3-3. No operation (Power is on).....	03-54
3-4. No cooling/No heating.....	03-55
3-5. Abnormal noise.....	03-57
3-6. Water leaking.....	03-58
3-7. Too warm.....	03-59
3-8. Too cool.....	03-63
4. Troubleshooting with error code (For wireless LAN adapter).....	03-67
4-1. E: 18.X. External communication error between indoor unit and WLAN adapter.....	03-67
4-2. Wireless LAN adapter error.....	03-68
4-3. Network communication error between wireless LAN router and WLAN adapter.....	03-69
4-4. E: 18.X. Communication error.....	03-71
4-5. E: 18.X. Wireless LAN adapter non-energized.....	03-73
4-6. Wireless LAN adapter Sleep mode (Indoor unit).....	03-74
4-7. Mobile app setting method.....	03-75
5. Service parts information.....	03-80
5-1. Compressor.....	03-80
5-2. Inverter compressor.....	03-81
5-3. Outdoor unit Electronic Expansion Valve (EEV).....	03-82
5-4. Indoor unit fan motor.....	03-84
5-5. Outdoor unit fan motor.....	03-85
5-6. Pressure switch.....	03-86
5-7. 4-way valve coil (solenoid coil)/4-way valve.....	03-87
6. Thermistor resistance values.....	03-88
6-1. Indoor unit.....	03-88
6-2. Outdoor unit.....	03-89

1. Error code

When a problem occurs in the system or the connected device, the error content is notified by displaying the code.

NOTE: This function is only available in a system with indoor or IR receiver units equipped with indicator lamps to show the error content.

Errors, once displayed, will be automatically stored in the PC board of the indoor unit. Even if the power is disconnected, the memory containing the error history will not be erased.

If another error occurs later, the stored error memory will be updated automatically and replaced with the new one. (Previous error will be erased.)

1-1. How to check the error memory

When an error occurs, the operation lamp (Green) and the timer lamp (Orange) indicate the error content by blinking. To check the error memory, follow the procedures below.

1. Stop the operation of the air conditioner, and then disconnect the power supply.
2. Reconnect the power supply.
3. In one of the following two methods, the memorized error is only displayed during the “3 minutes ST”^{*} state period.
 - Start the operation and then press the TEST RUN button on the remote controller.
 - Press the MANUAL AUTO button on the indoor unit for 10 seconds or more.

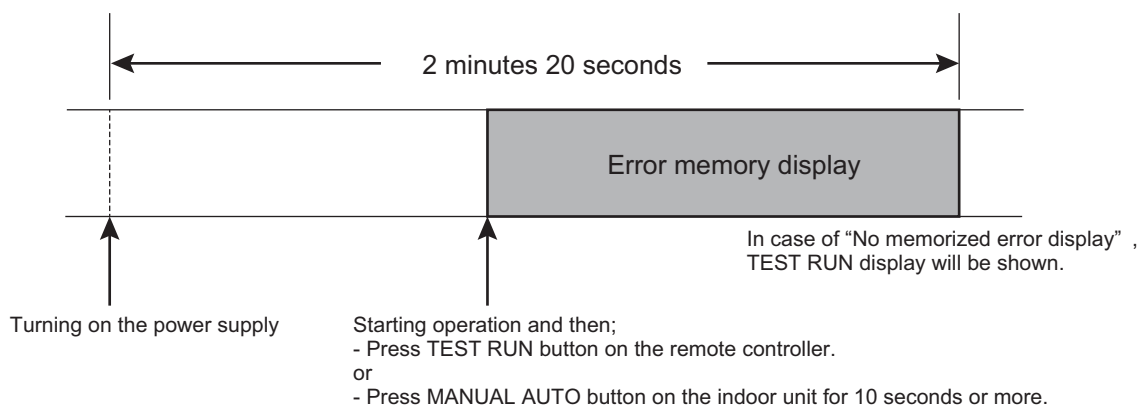

*: The “3 minutes ST” period lasts 2 minutes and 20 seconds after turning on the power supply.

1-2. How to erase the error memory

The error memory can be erased in one of the following two methods.

- Manual erase: Pressing the MANUAL AUTO button on the indoor unit while the “Error memory display” is being shown. (Short beep emits for about 3 seconds.)
- Automatic erase: After continuing the normal operation of the air conditioner without error for 2 hours or longer after displaying the error memory as described in [How to check the error memory](#). (Except FAN operation mode.)

1-3. Error code table (Indoor unit and wired remote controller)

The operation, timer, and economy indicators operate according to the error contents.

For confirmation of the error contents, refer the flashing pattern as follows.

Error contents	Indoor unit display			Wired remote controller display
	Operation [I] (Green)	Timer [⌚] (Orange)	Economy [E] (Green)	
E: 11.X. Serial communication error (Serial reverse transfer error) (Outdoor unit)	1 times	1 times	Continuous	11
E: 11.X. Serial communication error (Serial forward transfer error) (Indoor unit)	1 times	1 times	Continuous	11
E: 12.X. Wired remote controller communication error (Indoor unit)	1 times	2 times	Continuous	12
E: 18.X. External communication error (Indoor unit)	1 times	8 times	Continuous	18
E: 18.X. External communication error between indoor unit and WLAN adapter	1 times	8 times	Continuous	18
E: 18.X. Communication error	1 times	8 times	Continuous	18
E: 18.X. Wireless LAN adapter non-energized	1 times	8 times	Continuous	18
E: 23.X. Combination error (Outdoor unit)	2 times	3 times	Continuous	23
E: 26.X. Address setting error in wired remote controller (Indoor unit)	2 times	6 times	Continuous	26
E: 29.X. Connected unit number error (Indoor unit)	2 times	9 times	Continuous	29
E: 32.X. Indoor unit main PCB error (Indoor unit)	3 times	2 times	Continuous	32
E: 35.X. MANUAL AUTO button error (Indoor unit)	3 times	5 times	Continuous	35
E: 3A.X. Indoor unit communication circuit error (Indoor unit)	3 times	10 times	Continuous	3A
E: 41.X. Room temperature sensor error (Indoor unit)	4 times	1 times	Continuous	41
E: 42.X. Indoor unit heat exchanger sensor error (Indoor unit)	4 times	2 times	Continuous	42
E: 51.X. Indoor unit fan motor error (Indoor unit)	5 times	1 times	Continuous	51
E: 58.X. Intake grille error (Indoor unit)	5 times	8 times	Continuous	58
E: 62.X. Outdoor unit main PCB error (Outdoor unit)	6 times	2 times	Continuous	62
E: 63.X. Inverter error (Outdoor unit)	6 times	3 times	Continuous	63
E: 64.X. PFC circuit error (Outdoor unit)	6 times	4 times	Continuous	64
E: 65.X. Trip terminal L error (Outdoor unit)	6 times	5 times	Continuous	65
E: 71.X. Discharge thermistor error (Outdoor unit)	7 times	1 times	Continuous	71
E: 73.X. Heat exchanger (Middle/Outlet) temperature thermistor error (Outdoor unit)	7 times	3 times	Continuous	73
E: 74.X. Outdoor temperature thermistor error (Outdoor unit)	7 times	4 times	Continuous	74
E: 77.X. Heat sink thermistor error (Outdoor unit)	7 times	7 times	Continuous	77
E: 84.X. Current sensor error (Outdoor unit)	8 times	4 times	Continuous	84
E: 86.X. High pressure switch error (Outdoor unit)	8 times	6 times	Continuous	86
E: 86.X. Pressure sensor error (Outdoor unit)	8 times	6 times	Continuous	86
E: 94.X. Trip detection (Outdoor unit)	9 times	4 times	Continuous	94

Error contents	Indoor unit display			Wired remote controller display
	Operation [I] (Green)	Timer [⏰] (Orange)	Economy [E] (Green)	
E: 95.X. Compressor motor control error (Outdoor unit)	9 times	5 times	Continuous	95
E: 97.X. Outdoor unit fan motor error (Outdoor unit)	9 times	7 times	Continuous	97
E: 99.X. 4-way valve error (Outdoor unit)	9 times	9 times	Continuous	99
E: A1.X. Discharge temperature error (Outdoor unit)	10 times	1 times	Continuous	A1
E: A5.X. Low pressure error (Outdoor unit)	10 times	5 times	Continuous	A5
E: AC.X. Heat sink temperature error (Outdoor unit)	10 times	12 times	Continuous	AC

1-4. Error code table (Outdoor unit)

The operation status is determined by the lighting up and blinking of the LED lamp.

After check that ERROR LED lamp blinks, press the ENTER button once.

NOTE: For the positions of LED lamp and buttons, refer to "Function settings (Outdoor unit)" in Chapter 5. FIELD WORKING on page 05-13.

Error contents	POWER/ MODE	ERROR	PUMP DOWN	LOW NOISE		PEAK CUT		
			L1	L2	L3	L4	L5	L6
E: 11.X. Serial communication error (Serial forward transfer error) (Indoor unit) (Occurs immediately after starting operation)	■ 2	●	■ 1	■ 1	○	○	●	●
E: 11.X. Serial communication error (Serial forward transfer error) (Indoor unit) (Occurs during operation)	■ 2	●	■ 1	■ 1	○	●	○	○
E: 12.X. Wired remote controller communication error (Indoor unit)	■ 2	●	■ 5	■ 15	○	○	○	●
E: 18.X. External communication error (Indoor unit)	■ 2	●	■ 5	■ 15	○	○	○	●
E: 23.X. Combination error (Outdoor unit)	■ 2	●	■ 5	■ 15	○	○	○	●
E: 26.X. Address setting error in wired remote controller (Indoor unit)	■ 2	●	■ 5	■ 15	○	○	○	●
E: 29.X. Connected unit number error (Indoor unit)	■ 2	●	■ 5	■ 15	○	○	○	●
E: 32.X. Indoor unit main PCB error (Indoor unit)	■ 2	●	■ 5	■ 15	○	○	○	●
E: 35.X. MANUAL AUTO button error (Indoor unit)	■ 2	●	■ 5	■ 15	○	○	○	●
E: 3A.X. Indoor unit communication circuit error (Indoor unit)	■ 2	●	■ 5	■ 15	○	○	○	●
E: 41.X. Room temperature sensor error (Indoor unit)	■ 2	●	■ 5	■ 15	○	○	○	●
E: 42.X. Indoor unit heat exchanger sensor error (Indoor unit)	■ 2	●	■ 5	■ 15	○	○	○	●
E: 51.X. Indoor unit fan motor error (Indoor unit)	■ 2	●	■ 5	■ 15	○	○	○	●
E: 62.X. Outdoor unit main PCB error (Outdoor unit)	■ 2	●	■ 6	■ 2	○	○	○	●
E: 63.X. Inverter error (Outdoor unit)	■ 2	●	■ 6	■ 3	○	○	○	●
E: 65.X. Trip terminal L error (Outdoor unit)	■ 2	●	■ 6	■ 5	○	○	●	●
E: 71.X. Discharge thermistor error (Outdoor unit)	■ 2	●	■ 7	■ 1	○	○	○	●
E: 73.X. Heat exchanger (Middle/Outlet) temperature thermistor error (Outdoor unit)	■ 2	●	■ 7	■ 3	○	○	●	○
E: 74.X. Outdoor temperature thermistor error (Outdoor unit)	■ 2	●	■ 7	■ 4	○	○	○	●
E: 77.X. Heat sink thermistor error (Outdoor unit)	■ 2	●	■ 7	■ 7	○	○	○	●
E: 84.X. Current sensor error (Outdoor unit)	■ 2	●	■ 8	■ 4	○	○	○	●
E: 86.X. High pressure switch error (Outdoor unit)	■ 2	●	■ 8	■ 6	○	●	●	○

Error contents	POWER/ MODE	ERROR	PUMP DOWN	LOW NOISE		PEAK CUT		
			L1	L2	L3	L4	L5	L6
E: 86.X. Pressure sensor error (Outdoor unit)	■ 2	●	■ 8	■ 6	○	●	●	○
E: 94.X. Trip detection (Outdoor unit)	■ 2	●	■ 9	■ 4	○	○	○	●
E: 95.X. Compressor motor control error (Outdoor unit)	■ 2	●	■ 9	■ 5	○	○	○	●
E: 97.X. Outdoor unit fan motor error (Outdoor unit)	■ 2	●	■ 9	■ 7	○	○	●	●
E: 99.X. 4-way valve error (Outdoor unit)	■ 2	●	■ 9	■ 9	○	○	○	●
E: A1.X. Discharge temperature error (Outdoor unit)	■ 2	●	■ 10	■ 1	○	○	○	●
E: A5.X. Low pressure error (Outdoor unit)	■ 2	●	■ 10	■ 5	○	○	○	●
E: AC.X. Heat sink temperature error (Outdoor unit)	■ 2	●	■ 10	■ 12	○	○	●	●

● : Light on ○ : Light off ■ (n) : n Times blinking

1-5. Error code table (Wireless LAN indicator)

- Wireless LAN control system diagram example

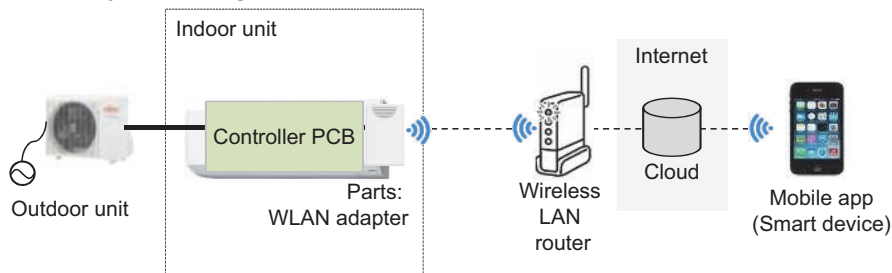

- Name of parts

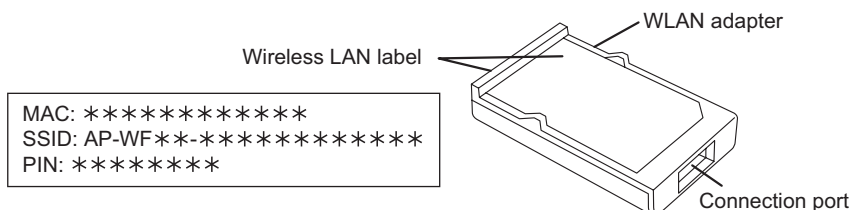

- Wireless LAN indicator lamps

For confirmation of the error contents, refer to the following flashing patterns.

Wireless LAN indicator lamp (orange) on the indoor unit operate according to the error contents.

Error contents	Wireless LAN LED (orange)	Error code
E: 18.X. External communication error between indoor unit and WLAN adapter	On: Connection information with router is available Off: Connection information with router is unavailable	18
Wireless LAN adapter error	Flashing slow	No error
Network communication error between wireless LAN router and WLAN adapter	On	No error
E: 18.X. Communication error	Flashing slow	18
E: 18.X. Wireless LAN adapter non-energized	Off	18
Wireless LAN adapter Sleep mode (Indoor unit)	Off	No error

Flashing slowly: Repeating 7 seconds on/2 seconds off

TROUBLESHOOTING

TROUBLESHOOTING

1-6. Error code table (Mobile App)

- Error display

If there is an abnormality on the air conditioning, refer to ⚠ as follows.

When the ⚠ (error button) on the home screen is tapped, error code and error name is displayed.

– For Android

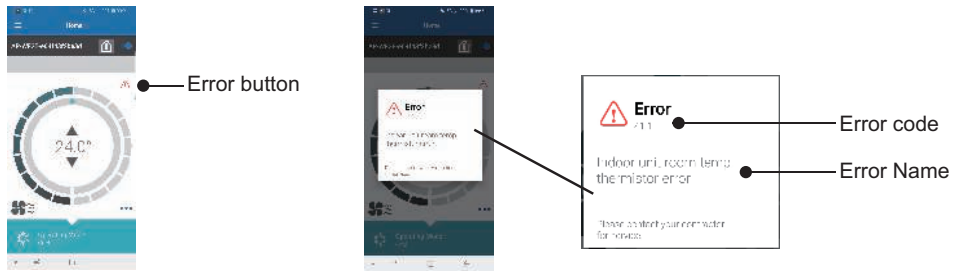

– For iOS

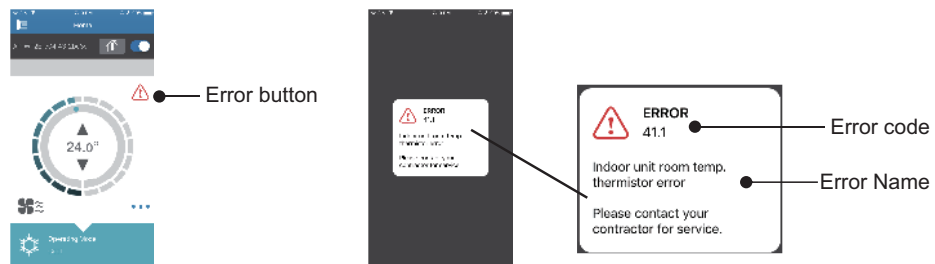

TROUBLESHOOTING

TROUBLESHOOTING

- Error code

Error message	Error contents	Error code
Serial communication error (Serial Reverse Transfer Error)	E: 11.X. Serial communication error (Serial reverse transfer error) (Outdoor unit)	11.1
		11.2
Serial communication error (Serial Forward Transfer Error)	E: 11.X. Serial communication error (Serial forward transfer error) (Indoor unit)	11.3
		11.4
Wired remote controller communication error	E: 12.X. Wired remote controller communication error (Indoor unit)	12.1
Indoor unit PCB model information error	E: 32.X. Indoor unit main PCB error (Indoor unit)	32.1
Manual auto switch error	E: 35.X. MANUAL AUTO button error (Indoor unit)	35.1
Room temp. sensor error	E: 41.X. Room temperature sensor error (Indoor unit)	41.1
Indoor unit Heat Ex. Middle temp. sensor error	E: 42.X. Indoor unit heat exchanger sensor error (Indoor unit)	42.2
Indoor unit fan motor error	E: 51.X. Indoor unit fan motor error (Indoor unit)	51.1
		51.2
Outdoor unit main PCB model information error	E: 62.X. Outdoor unit main PCB error (Outdoor unit)	62.1
		62.2
Inverter error	E: 63.X. Inverter error (Outdoor unit)	63.1
		63.2
PC circuit error	E: 64.X. PFC circuit error (Outdoor unit)	64.1
		64.3
		64.4
		64.8
Discharge temp. sensor error	E: 71.X. Discharge thermistor error (Outdoor unit)	71.1
Outdoor temp. sensor error	E: 74.X. Outdoor temperature thermistor error (Outdoor unit)	74.1
Current sensor error	E: 84.X. Current sensor error (Outdoor unit)	84.1
Trip detection	E: 94.X. Trip detection (Outdoor unit)	94.1
Compressor rotor position detection error	E: 95.X. Compressor motor control error (Outdoor unit)	95.1
		95.3
Outdoor unit fan motor error	E: 97.X. Outdoor unit fan motor error (Outdoor unit)	97.3
4-way valve error	E: 99.X. 4-way valve error (Outdoor unit)	99.1
Discharge temp. error	E: A1.X. Discharge temperature error (Outdoor unit)	A1.1

1-7. Error message for wireless LAN control (Mobile App)

- Error display
If there is an abnormality on the wireless control system, refer to error messages as follows.
The error message disappears after 5 seconds and the normal screen is displayed.

For Android

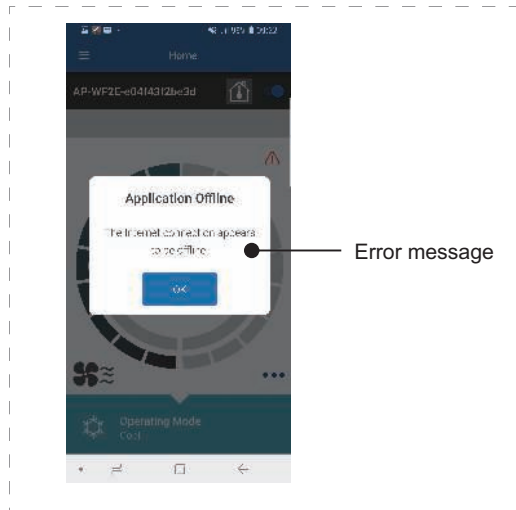

For iOS

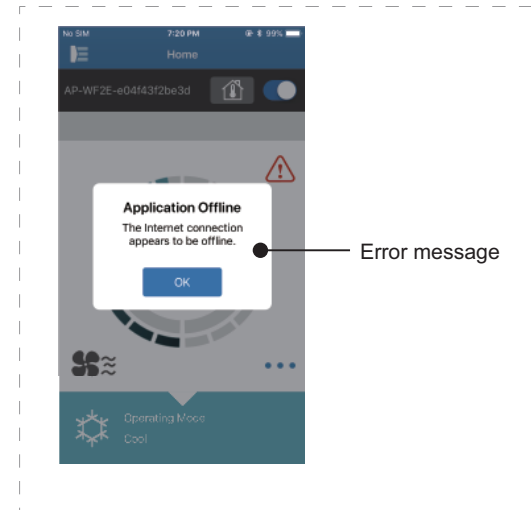

- Error message list
 - For Android

Registration error		
Error message	Cause	Solution
Wi-Fi must be enabled to set up new device	The user has disabled the wireless LAN connection on the smart device.	Enable the wireless LAN connection on the smart device.
We weren't able to sign you onto null. Please goto the Wi-Fi settings and join the network from there. Return to the app when you're done.	The smart device and air conditioner are connected to difference wireless LAN networks when attempting to register.	Connect the mobile device to the same network as air conditioner, then retry the registration.
Could not connect to the device at this time. Please reset the device and try again.	The air conditioner is not connected to the wireless LAN.	Check if the router connected to the air conditioner has Internet access. (You can check by connecting the smart device to the router, then opening the website.) If there is no access, connect the router to the Internet.
	Smart device is not connected to the same network as the air conditioner.	Connect the mobile device to the same network as the air conditioner, then retry the registration.
The device failed to connect with service.	Your Internet access may be down or a firewall may be blocking requests to the service.	Check if the router connected to the air conditioner has Internet access. (You can check by connecting the smart device to the router, then opening the website.) If there is no access, connect the router to the Internet.
Could not register the device. Make sure the device is ready for registration.	The air conditioner is not connected to the router.	Enter the wireless LAN setting on the smart device, then check if the SSID of the air conditioner (AP-WF**-*-*-*-*-*-*-**) is connected. If the air conditioner is connected, retry the registration.
	The router the air conditioner is connected to, has no Internet access.	Check if the router connected to the air conditioner has Internet access. (You can check by connecting the smart device to the router, then opening the website.) If there is no access, connect the router to the Internet.
	The air conditioner is already registered.	If there is a smart device that has already been registered to the air conditioner, unregister by using the registered smart device. Retry the registration with the smart device you wish to register. If you do not own the smart device registered to the air conditioner (lost, property of previous owner, etc.), ask your manufacturer service to unregister the smart device. Inform them the MAC address of the WLAN Adapter as written on the Wireless LAN label.
	If the problem persists even if the all of the above is conducted, contact your dealer or authorized service personnel. When asking for advice, inform them the MAC address of the WLAN Adapter as written on the Wireless LAN label.	
Please ensure your air conditioner is ready to pair, and that you have entered its SSID and password correctly.	Occurs when pairing is executed, when the user erroneously enter the SSID of the adapter.	Enter the SSID literally. (Uppercase and lowercase letters also match)

General error		
Error message	Cause	Solution
No connectivity to Wi-Fi or the cloud. Please check your network connection.	The smart device has no Internet access.	Connect the mobile device to the Internet.
An error occurred while trying to update your profile. Please try again later.		
Device is off-line and cannot be modified.	The router the air conditioner is connected to, has no Internet access.	Check if the router connected to the air conditioner has Internet access. (You can check by connecting the mobile device to the router, then opening the website.) If there is no access, connect the router to the Internet.
	The air conditioner is not connected to the router.	Check the wireless LAN indicator lamps on the air conditioner. If the indicator lamp is flashing or off, refer to "Error code table (Wireless LAN indicator)" on page 03-6

Sign in error		
Error message	Cause	Solution
Could not reach service.	The smart device has no Internet access.	Connect the smart device to the Internet.

– For iOS

Registration error		
Error message	Cause	Solution
You need an Internet connection to add new devices.	The user has disabled the wireless LAN connection on their smart device.	Enable the wireless LAN connection from the iOS setting.
Could not register same LAN device. Make sure both devices are in the same LAN and try again to register.	The smart device and air conditioner are connected to different wireless LAN networks when attempting to register.	Connect the smart device to the same network as the air conditioner, then retry the registration.
No registrable device was found. Make sure Wi-Fi setup was successful. This method only works if the Wi-Fi was recently performed.	The air conditioner is not connected to the wireless LAN.	Check if the router connected to the air conditioner has Internet access. (You can check by connecting the smart device to the router, then opening the website.) If there is no access, connect the router to the Internet.
	Smart device is not connected to the same network as the air conditioner.	Connect the mobile device to the same network as the air conditioner, then tap register button.
Could not register the device. Make sure the device is ready for registration.	The air conditioner is not connected to the router.	Enter the wireless LAN setting on the smart device, then check if the SSID of the air conditioner (AP-WF**-*****-*****) is connected. If the air conditioner is connected, retry the registration.

Registration error		
Error message	Cause	Solution
Could not register the device. Make sure the device is ready for registration.	The router the air conditioner is connected to, has no Internet access.	Check if the router connected to the air conditioner has Internet access. (You can check by connecting the smart device to the router, then opening the website.) If there is no access, connect the router to the Internet, then retry the registration.
	The air conditioner is already registered.	If there is a smart device that has already been registered to the air conditioner, unregister by using the registered smart device. Retry the registration with the smart device you wish to register. If you do not own the smart device registered to the air conditioner (lost, property of previous owner, etc.), ask your manufacturer service to unregister the smart device. Inform them the MAC address of the WLAN Adapter as written on the Wireless LAN label.
	If the problem persists even if the all of the above is conducted, contact your dealer or authorized service personnel. When asking for advice, inform them the MAC address of the WLAN Adapter as written on the Wireless LAN label.	
Please ensure your air conditioner is ready to pair, and that you have entered its SSID and password correctly.	Occurs when pairing is executed, when the user erroneously enter the SSID of the adapter.	Enter the SSID literally. (Uppercase and lowercase letters also match)

General error		
Error message	Cause	Solution
Failed to change password. Cloud not determine service reachability. Failed to update property. Could not retrieve schedules. The operation couldn't be completed. Operation timed out.	The smart device has no Internet access.	Connect the mobile device to the Internet.
"Device name" is off-line. (Device name varies depending on the air conditioner)	The router the air conditioner is connected to has no Internet access.	Check if the router connected to the air conditioner has Internet access. (You can check by connecting the mobile device to the router, then opening the website to check access.) If there is no access, connect the router to the Internet.
	The air conditioner is not connected to the router.	Check the wireless LAN indicator lamps on the air conditioner. If the indicator lamp is flashing or off, refer to " Error code table (Wireless LAN indicator) " on page 03-6

Sign in error		
Error message	Cause	Solution
Could not reach service.	The smart device has no Internet access.	Connect the smart device to the Internet.

2. Troubleshooting with error code

2-1. E: 11.X. Serial communication error (Serial reverse transfer error) (Outdoor unit)

Indicator	Indoor unit	Operation indicator	1 time flash
		Timer indicator	1 time flash
		Economy indicator	Continuous flash
		Error code	E: 11
	outdoor unit	Refer to " Error code table (Outdoor unit) " on page 03-4	
Detective actuator	Outdoor unit	Main PCB	When the indoor unit cannot receive the serial signal from outdoor unit more than 2 minutes after power on, or the indoor unit cannot receive the serial signal more than 15 seconds during normal operation.
		Fan motor	
Forecast of cause		Connection failure	
		External cause	
		Main PCB failure	
		Outdoor unit fan motor failure	

Check point 1. Reset the power and operate

Does error indication show again?

→ If no, go to "[Check point 1-2](#)".



Check point 2. Check connection

Check any loose or removed connection line of indoor unit and outdoor unit.

Check connection condition is control unit. (If there is loose connector, open cable or mis-wiring.)

→ If there is an abnormal condition, correct it by referring to the installation manual or the "DESIGN & TECHNICAL MANUAL".



Check point 3. Check the voltage of power supply

Check the voltage of power supply

Check if AC 187 V (AC 208 V -10%) to AC 253 V (AC 230 V +10%) appears at outdoor unit terminal L—N.

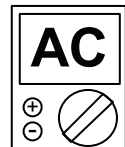

Check point 4. Check serial signal (Reverse transfer signal)

Check serial signal (Reverse transfer signal)

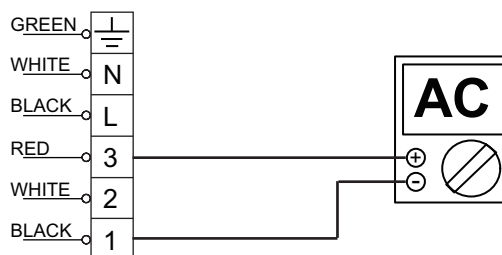

- Check if indicated value swings between AC 90 V and AC 270 V at the outdoor unit terminal 1—3.
- If it is abnormal, check the parts below.
 - Outdoor unit fan motor in "[Service parts information](#)" on page 03-80
- If outdoor fan motor is abnormal, replace outdoor unit fan motor and main PCB.
- If the checked parts are normal, replace the main PCB.



End

Check point 1-2. Check external cause such as noise

- Check the complete insulation of the grounding.
- Check if there is any equipment that causes harmonic wave near the power cable (Neon light bulb or any electronic equipment which causes harmonic wave).



End

2-2. E: 11.X. Serial communication error (Serial forward transfer error) (Indoor unit)

Indicator	Indoor unit	Operation indicator	1 time flash
		Timer indicator	1 time flash
		Economy indicator	Continuous flash
		Error code	E: 11
	Outdoor unit	Refer to " Error code table (Outdoor unit) " on page 03-4	
Detective actuator	Indoor unit	Main PCB	When the indoor unit cannot receive the serial signal from outdoor unit more than 2 minutes after power on, or the indoor unit cannot receive the serial signal more than 15 seconds during normal operation.
		Fan motor	
Forecast of cause		Connection failure	
		External cause	
		Main PCB failure	
		Indoor unit fan motor failure	

Check point 1. Reset the power and operate

Does error indication show again?

→ If no, go to "[Check point 1-2](#)".



Check point 2. Check connection

Check any loose or removed connection line of indoor unit and outdoor unit.

Check connection condition is control unit. (If there is loose connector, open cable or mis-wiring.)

→ If there is an abnormal condition, correct it by referring to the installation manual or the *DESIGN & TECHNICAL MANUAL*.



Check point 3. Check the voltage of power supply

Check the voltage of power supply

Check if AC 187 V (AC 208 V -10%) to AC 253 V (AC 230 V +10%) appears at outdoor unit terminal L—N.

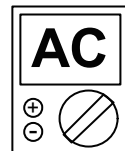

Check point 4. Check serial signal (reverse transfer signal)

Check serial signal (Forward transfer signal)

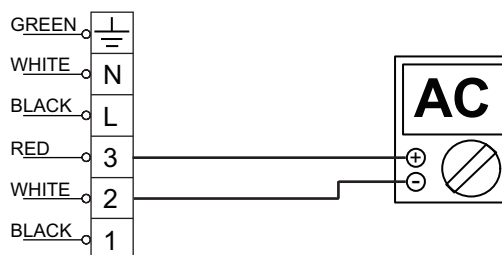

- Check if indicated value swings between AC 30 V and AC 130 V at outdoor unit terminal 2—3.
- If it is abnormal, replace main PCB.
- If it is abnormal, check indoor unit fan motor. (Indoor unit fan motor in "[Service parts information](#)" on page 03-80)
- If indoor unit fan motor is abnormal, replace indoor unit fan motor and main PCB.



End

Check point 1-2. Check external cause such as noise

- Check the complete insulation of the grounding.
- Check if there is any equipment that causes harmonic wave near the power cable (Neon light bulb or any electronic equipment which causes harmonic wave).



End

2-3. E: 12.X. Wired remote controller communication error (Indoor unit)

Indicator	Indoor unit	Operation indicator	1 time flash
		Timer indicator	2 time flash
		Economy indicator	Continuous flash
		Error code	E: 12
	outdoor unit		Refer to " Error code table (Outdoor unit) " on page 03-4
Detective actuator	Indoor unit	Main PCB	When the indoor unit cannot receive the signal from Wired remote controller more than 1 minute during normal operation.
	Wired remote control		
Forecast of cause			Terminal connection abnormal
			Wired remote control failure
			Main PCB failure

Check point 1. Check the connection of terminal

After turning off the power, check & correct the followings.

- Check the connection of terminal between remote controller and indoor unit, and check if there is a disconnection of the cable.



Check point 2. Check connection

Check voltage at CN2 (terminal 1—3) of UTY-TWRXZ2 (Communication kit) (for 18 model). Check voltage at CN12 of main PCB (terminal 1—2) (for 24 model). (Power supply to the remote controller)



Upon correcting the removed connector or mis-wiring, reset the power.

- If it is DC 5 V (for 18 model) or DC 12 V (for 24 model), remote controller is failure. (Main PCB is normal)
 - Replace Remote Control
- If it is DC 0 V, main PCB is failure. (Check remote controller once again)
 - Replace main PCB



End

2-4. E: 18.X. External communication error (Indoor unit)

Indicator	Indoor unit	Operation indicator	1 time flash
		Timer indicator	8 time flash
		Economy indicator	Continuous flash
		Error code	E: 18
	outdoor unit		Refer to " Error code table (Outdoor unit) " on page 03-4
Detective actuator	Indoor unit	External communication error	After receiving a signal from the external input and output PCB, the same signal has not been received for 15 seconds.
Forecast of cause			Connection failure
			WLAN adapter failure
			Main PCB

Check point 1. Check the connection

- Check any loose or removed connection between the main PCB to the WAN adapter.
-> If there is an abnormal condition, correct it by refer to the installation manual or the "DESIGN & TECHNICAL MANUAL".
- Check the connection condition on the WLAN adapter and the main PCB (If there is loose connector, open cable or mis-wiring.)



Check point 2. Replace the WLAN adapter

If check point 1 do not improve the symptom, change WLAN adapter.



Check point 3. Replace main PCB

If check point 2 do not improve the symptom, change main PCB



End

2-5. E: 23.X. Combination error (Outdoor unit)

Indicator	Indoor unit	Operation indicator	2 time flash
		Timer indicator	3 time flash
		Economy indicator	Continuous flash
		Error code	E: 23
	Outdoor unit	Refer to " Error code table (Outdoor unit) " on page 03-4	
Detective actuator	Indoor unit	The outdoor unit receives the serial signal of applied refrigerant information from indoor unit.	
Forecast of cause		Incorrect indoor unit is selected.	

Check point 1. Check the type of indoor unit

- Check the type of the connected indoor unit.
-> If there is an abnormal condition, correct it by refer to the installation manual or the "DESIGN & TECHNICAL MANAL".



Check point 2. Replace main PCB

If check point 1 do not improve the symptom, replace main PCB of the outdoor unit.



End

2-6. E: 26.X. Address setting error in wired remote controller (Indoor unit)

Indicator	Indoor unit	Operation indicator	2 time flash
		Timer indicator	6 time flash
		Economy indicator	Continuous flash
		Error code	E: 26
	outdoor unit	Refer to " Error code table (Outdoor unit) " on page 03-4	
Detective actuator	Wired remote controller (2-wire)	<ul style="list-style-type: none"> When the address number set by auto setting and manual setting are mixed in one remote controller group When the duplicated address number exists in one remote controller group 	
	Indoor unit controller PCB		
Forecast of cause			Wrong wiring of remote controller group
			Wrong remote controller address setting
			Indoor unit main PCB failure
			Remote controller failure

Check point 1. Wire installation

- Check the wire connection in the remote controller group (For installation method, refer to installation manual)
-> If there is an abnormal condition, correct it by refer to the installation manual or the "DESIGN & TECHNICAL MANUAL".



Check point 2. Wrong remote controller group setting

- The given address number by auto setting (00) and the manual set number (except 00) are not existing in one remote controller group.
- The remote controller address setting by UI is not existing same address.
- The duplicate address number is not existing in one remote controller group.



Check point 3. Check indoor unit main PCB

- Check if main PCB is damaged.
- Change main PCB and check the error after setting remote controller address.



End

2-7. E: 29.X. Connected unit number error (Indoor unit)

Indicator	Indoor unit	Operation indicator	2 time flash
		Timer indicator	9 time flash
		Economy indicator	Continuous flash
		Error code	E: 29
	outdoor unit	Refer to " Error code table (Outdoor unit) " on page 03-4	
Detective actuator	Wired remote controller (2-wire)	When the number of the connected indoor unit exceeds the limitation.	
	Indoor unit main PCB		
Forecast of cause	Wrong wiring of indoor unit or remote controller		
	Number of indoor unit or remote controller in remote controller group		
	Indoor unit main PCB failure		

Check point 1. Wire installation

- Wrong number of connected indoor unit
-> If there is an abnormal condition, correct it by refer to the installation manual or the "DESIGN & TECHNICAL MANUAL".



Check point 2. Check indoor unit main PCB

- Check if main PCB is damaged.
- Change main PCB and check the error after setting remote controller address.



End

2-8. E: 32.X. Indoor unit main PCB error (Indoor unit)

Indicator	Indoor unit	Operation indicator	3 time flash
		Timer indicator	2 time flash
		Economy indicator	Continuous flash
		Error code	E: 32
	outdoor unit	Refer to " Error code table (Outdoor unit) " on page 03-4	
Detective actuator	Indoor unit	main PCB	When power is on and there is some below case. 1. When model information of EEPROM is incorrect. 2. When the access to EEPROM failed.
Forecast of cause			External cause
			Defective connection of electric components
			Main PCB failure

Check point 1. Reset power supply and operate

Does error indication show again?

→ If no, go to "[Check point 1-2](#)".



Check point 2. Check Indoor unit electric components

- Check all connectors. (loose connector or incorrect wiring)
- Check any shortage or corrosion on PCB.



Check point 3. Replace main PCB

Change main PCB.



End

Check point 1-2. Check external cause such as noise

- Check if the ground connection is proper.
- Check if there is any equipment that causes harmonic wave near the power cable (Neon light bulb or any electronic equipment which causes harmonic wave).



End

NOTE: EEPROM

EEPROM (Electrically Erasable and Programmable Read Only Memory) is a non-volatile memory which keeps memorized information even if the power is turned off. It can change the contents electronically. To change the contents, it uses higher voltage than normal, and it cannot change a partial contents. (Rewriting shall be done upon erasing the all contents.) There is a limit in a number of rewriting.

2-9. E: 35.X. MANUAL AUTO button error (Indoor unit)

Indicator	Indoor unit	Operation indicator	3 time flash
		Timer indicator	5 time flash
		Economy indicator	Continuous flash
		Error code	E: 35
	outdoor unit	Refer to " Error code table (Outdoor unit) " on page 03-4	
Detective actuator	Indoor unit controller PCB	When the MANUAL AUTO button becomes on for consecutive 30 (for 18 model) or 60 (for 24 model) or more seconds.	
	Indicator PCB		
	Manual auto switch		
Forecast of cause	MANUAL AUTO button failure		
	Controller PCB and indicator PCB failure		

Check point 1. Check the MANUAL AUTO button

- Check if MANUAL AUTO button is kept pressed.
- Check On/Off switching operation by using a meter.



If MANUAL AUTO button is disabled (on/off switching), replace it.



Check point 2. Replace main PCB and indicator PCB

If Check Point 1 does not improve the symptom, change main PCB and indicator PCB.



End

2-10. E: 3A.X. Indoor unit communication circuit error (Indoor unit)

Indicator	Indoor unit	Operation indicator	3 time flash
		Timer indicator	10 time flash
		Economy indicator	Continuous flash
		Error code	E: 3A
	outdoor unit	Refer to " Error code table (Outdoor unit) " on page 03-4	
Detective actuator	Wired remote controller (2-wire)	When the indoor unit detects the configuration of remote controller group abnormal or the indoor unit detects lack of the primary remote controller	
	Indoor unit controller PCB circuit		
Forecast of cause			Terminal connection abnormal
			Wired remote controller failure
			Indoor unit main PCB defective

Check point 1. Check the connection of terminal

- After turning off the power supply, check and correct as follows:
Indoor unit: Check the connection of the terminal between the remote controller and indoor unit, or between indoor units and check if there is a disconnection or short of the cable.



Check point 2. Check the indoor unit main PCB

- Check terminal voltage of CN2 (terminal 1—3) of UTY-TWRXZ2 (Communication kit) (for 18 model). Check voltage at CN12 of main PCB (terminal 1—2) (for 24 model) (Power supply for remote)
If terminal voltage is DC 5 V (for 18 model) or DC 12 V (for 24 model), remote controller failure (Control PCB is OK).
If terminal voltage is DC 0 V, main PCB failure (Remote controller is OK).





NOTE: In case of re-installation is done due to removed connector or incorrect wiring, turn on the power again.



End

Tip

Depending on the connected remote controller type, following setting is required:

Connected remote controller	DIP switch	Jumper (JM9)
2-wire type	 2WIRE/3WIRE Factory setting: 2WIRE	 JM9 Disconnected
3-wire type	 2WIRE/3WIRE Factory setting: 3WIRE	 JM9 Connected (Factory setting)

- 2-wire type remote main PCB
 If the communication PCB is not connected and JM9 is disconnected, 3A error is displayed.
 If the communication PCB is connected and JM9 is connected, the 2-wire remote controller does not work.
 If the DIP switch is 3-wire side, the 2-wire type remote controller does not work.
- 3-wire type remote main PCB
 If the DIP switch is 2-wire side, the 3-wire type remote controller does not work.

2-11. E: 41.X. Room temperature sensor error (Indoor unit)

Indicator	Indoor unit	Operation indicator	4 time flash
		Timer indicator	1 time flash
		Economy indicator	Continuous flash
		Error code	E: 41
	outdoor unit	Refer to " Error code table (Outdoor unit) " on page 03-4	
Detective actuator	Indoor unit main PCB	Room temperature thermistor is open or short is detected always.	
	Room temperature thermistor		
Forecast of cause		Connector failure	
		Thermistor failure	
		Main PCB failure	

Check point 1. Check connection of connector

- Check if connector is loose or removed.
- Check erroneous connection.
- Check if thermistor cable is open

-> Reset power when reinstalling due to removed connector or incorrect wiring.



Check point 2. Remove connector and check thermistor resistance value

- For the room thermistor resistance value, refer to "[Thermistor resistance values](#)" on page 03-88.
- If thermistor is either open or shorted, replace it and reset the power.

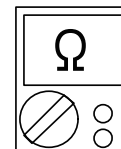

Check point 3. Check voltage of main PCB

Make sure circuit diagram of each indoor unit and check terminal voltage at thermistor (DC 5.0 V).

NOTE: For details of thermistor connector, refer to "[Wiring diagrams](#)" in Chapter 2. TECHNICAL DATA AND PARTS LIST on page 02-18.



If the voltage does not appear, replace main PCB.



End

2-12. E: 42.X. Indoor unit heat exchanger sensor error (Indoor unit)

Indicator	Indoor unit	Operation indicator	4 time flash
		Timer indicator	2 time flash
		Economy indicator	Continuous flash
		Error code	E: 42
	outdoor unit	Refer to " "Error code table (Outdoor unit)" on page 03-4	
Detective actuator	Indoor unit main PCB	When heat exchanger temperature thermistor open or short circuit is detected.	
	Heat exchanger temperature thermistor		
Forecast of cause		Connector connection failure	
		Thermistor failure	
		Main PCB failure	

Check point 1. Check connection of connector

- Check if connector is loose or removed.
- Check erroneous connection.
- Check if thermistor cable is open

-> Reset power when reinstalling due to removed connector or incorrect wiring.



Check point 2. Remove connector and check thermistor resistance value

- For the heat exchanger thermistor resistance value, refer to "["Thermistor resistance values"](#) on page 03-88.
- If thermistor is either open or shorted, replace it and reset the power.

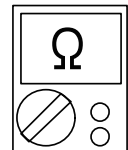

Check point 3. Check voltage of main PCB

Make sure circuit diagram of each indoor unit and check terminal voltage at thermistor (DC 5.0 V).

NOTE: For details of thermistor connector, refer to "["Wiring diagrams"](#) in Chapter 2. TECHNICAL DATA AND PARTS LIST on page 02-18.



If the voltage does not appear, replace main PCB.



End

2-13. E: 51.X. Indoor unit fan motor error (Indoor unit)

Indicator	Indoor unit	Operation indicator	5 time flash
		Timer indicator	1 time flash
		Economy indicator	Continuous flash
		Error code	E: 51
	outdoor unit		Refer to " Error code table (Outdoor unit) " on page 03-4
Detective actuator	Indoor unit	main PCB	When the actual rotation number of the indoor unit fan motor is below 1/3 of the target rotation number continuously for more than 56 seconds.
		Fan motor	
Forecast of cause			Fan rotation failure
			Fan motor winding open
			Motor protection by surrounding temperature rise
			Control PCB failure
			Indoor unit fan motor failure

Check point 1. Check rotation of fan

Rotate the fan by hand when operation is off. (Check if fan is caught, dropped off or locked motor)
→ If fan or bearing is abnormal, replace it.



Check point 2. Check ambient temperature around motor

Check excessively high temperature around the motor. (If there is any surrounding equipment that causes heat)
→ Upon the temperature coming down, restart operation.



Check point 3. Check indoor unit fan motor

Check Indoor unit fan motor. (Refer to indoor unit fan motor in "[Service parts information](#)" on page 03-80.)
→ If Indoor unit fan motor is abnormal, replace Indoor unit fan motor.



Check point 4. Replace main PCB

If Check Point 1 to 3 do not improve the symptom, replace main PCB.



End

2-14. E: 58.X. Intake grille error (Indoor unit)

Indicator	Indoor unit	Operation indicator	5 time flash
		Timer indicator	8 time flash
		Economy indicator	Continuous flash
		Error code	E: 58
	Outdoor unit	Refer to " Error code table (Outdoor unit) " on page 03-4	
Detective actuator	Indoor unit main PCB	When the Micro switch is detected open while running the compressor.	
	Micro switch		
Forecast of cause			Micro switch failure
			Shorted connector/wire
			Main PCB failure

Check point 1. Check limit switch

- Check operation of Micro switch. (any blocking by dust, etc.)
- Remove Micro switch and check ON/OFF switching operation by using a meter.

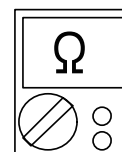

-> If micro switch is detective, replace it.



Check point 2. Check connector (CN11)/wire

Check loose contact of CN11/shorted wire (pinched wire).

-> Replace micro switch if the wire is abnormal



Check point 3. Replace main PCB

If Check Point 1 and 2 do not improve the symptom, change main PCB.



End

2-15. E: 62.X. Outdoor unit main PCB error (Outdoor unit)

Indicator	Indoor unit	Operation indicator	6 time flash
		Timer indicator	2 time flash
		Economy indicator	Continuous flash
		Error code	E: 62
	outdoor unit	Refer to " Error code table (Outdoor unit) " on page 03-4	
Detective actuator	Outdoor unit	Main PCB	Access to EEPROM failed due to some cause after outdoor unit started.
Forecast of cause			External cause (Noise, temporary open, voltage drop)
			Main PCB failure

Check point 1. Reset power supply and operate

Does error indication show again?

If no, go to "[Check point 1-2](#)".



Check point 2. Replace main PCB

Change main PCB.



End

Check point 1-2. Check external cause

- Check if temporary voltage drop was not generated.
- Check if momentary open was not generated.
- Check if ground is connection correctly or there are no related cables near the power line.



End

2-16. E: 63.X. Inverter error (Outdoor unit)

Indicator	Indoor unit	Operation indicator	6 time flash
		Timer indicator	3 time flash
		Economy indicator	Continuous flash
		Error code	E: 63
	outdoor unit	Refer to " Error code table (Outdoor unit) " on page 03-4	
Detective actuator	Outdoor unit	Inverter PCB	Error information received from inverter PCB
Forecast of cause			External cause
			Power supply to inverter PCB wiring disconnection or open
			Inverter PCB failure

Check point 1. Turn the power on again?

Error displayed again?

If no, go to "[Check point 1-2](#)".



Check point 2. Check the wiring (power supply to inverter PCB)

- Connector and wiring connection state check
- Cable open check



Check point 3. Replace inverter PCB

Replace inverter PCB



End

Check point 1-2. Check external cause

- Check if temporary voltage drop was not generated.
- Check if momentary open was not generated.
- Check if ground is connection correctly or there are no related cables near the power line.



End

2-17. E: 64.X. PFC circuit error (Outdoor unit)

Indicator	Indoor unit	Operation indicator	6 time flash
		Timer indicator	4 time flash
		Economy indicator	Continuous flash
		Error code	E: 64
	outdoor unit	Refer to " Error code table (Outdoor unit) " on page 03-4	
Detective actuator	Outdoor unit	Main PCB	<ul style="list-style-type: none"> When inverter input DC voltage is higher than 420 V for over 3 seconds, the compressor stops. If the same operation is repeated 5 times, the compressor stops permanently.
Forecast of cause			External cause
			Connector connection failure
			Main PCB failure

Check point 1. Check external cause at indoor and outdoor (Voltage drop or Noise)

- Instant drop: Check if there is a large load electric apparatus in the same circuit.
- Momentary power failure: Check if there is a defective contact or leak current in the power supply circuit.
- Noise: Check if there is any equipment causing harmonic wave near electric line. (Neon bulb or electric equipment that may cause harmonic wave)
Check the complete insulation of grounding.



Check point 2. Check connection of Connector

- Check if connector is removed.
- Check erroneous connection.
- Check if cable is open.

→ Upon correcting the removed connector or mis-wiring, reset the power.



Check point 3. Replace main PCB

If check point 1 to 2 do not improve the symptom, change main PCB.



End

2-18. E: 65.X. Trip terminal L error (Outdoor unit)

Indicator	Indoor unit	Operation indicator	6 time flash
		Timer indicator	5 time flash
		Economy indicator	Continuous flash
		Error code	E: 65
	outdoor unit	Refer to " Error code table (Outdoor unit) " on page 03-4	
Detective actuator	Outdoor unit	Main PCB	When the signal from FO terminal of IPM is "L" (0 V) during the compressor stopping.
Forecast of cause			Main PCB failure

Check point 1. Check main PCB

Replace the outdoor unit main PCB.



End

2-19. E: 71.X. Discharge thermistor error (Outdoor unit)

Indicator	Indoor unit	Operation indicator	7 time flash
		Timer indicator	1 time flash
		Economy indicator	Continuous flash
		Error code	E: 71
	outdoor unit	Refer to " Error code table (Outdoor unit) " on page 03-4	
Detective actuator	Outdoor unit main PCB	When discharge pipe temperature thermistor open or short circuit is detected at power on or while running the compressor	
	Discharge pipe temperature thermistor		
Forecast of cause			Connector failure
			Thermistor failure
			Main PCB failure

Check point 1. Check connection of connector

- Check if connector is loose or removed.
- Check erroneous connection.
- Check if thermistor cable is open

→ Reset power when reinstalling due to removed connector or incorrect wiring.



Check point 2. Remove connector and check thermistor resistance value

- For the discharge temperature thermistor resistance value, refer to "[Thermistor resistance values](#)" on page 03-88.
- If thermistor is either open or shorted, replace it and reset the power.

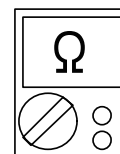

Check point 3. Check voltage of main PCB

Make sure circuit diagram of outdoor unit and check terminal voltage at thermistor (DC 5.0 V).

NOTE: For details of thermistor connector, refer to "[Wiring diagrams](#)" in Chapter 2. TECHNICAL DATA AND PARTS LIST on page 02-18.



If the voltage does not appear, replace main PCB.



End

2-20. E: 73.X. Heat exchanger (Middle/Outlet) temperature thermistor error (Outdoor unit)

Indicator	Indoor unit	Operation indicator	7 time flash
		Timer indicator	3 time flash
		Economy indicator	Continuous flash
		Error code	E: 73
	outdoor unit	Refer to " Error code table (Outdoor unit) " on page 03-4	
Detective actuator	Heat exchanger liquid temperature thermistor	• Heat exchanger liquid temperature thermistor short or open detected	
	Heat exchanger middle temperature thermistor	• Heat exchanger middle temperature thermistor short or open detected	
Forecast of cause		Connector failure	
		Thermistor failure	
		Main PCB failure	

Check Point 1 : Check the connector connection and cable open

- Connector connection state check
- Cable open check



Check Point 2 : Check the thermistor

- For the outdoor unit heat exchanger thermistor resistance value, refer to "[Thermistor resistance values](#)" on page 03-88.
- If thermistor is either open or shorted, replace it and reset the power.

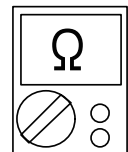

Check point 3. Check voltage of main PCB

Make sure circuit diagram of outdoor unit and check terminal voltage at thermistor (DC 5.0 V).

NOTE: For details of thermistor connector, refer to "[Wiring diagrams](#)" in Chapter 2. TECHNICAL DATA AND PARTS LIST on page 02-18.



If the voltage does not appear, replace main PCB.



End

2-21. E: 74.X. Outdoor temperature thermistor error (Outdoor unit)

Indicator	Indoor unit	Operation indicator	7 time flash
		Timer indicator	4 time flash
		Economy indicator	Continuous flash
		Error code	E: 74
	outdoor unit	Refer to " Error code table (Outdoor unit) " on page 03-4	
Detective actuator	Outdoor unit main PCB	When outdoor temperature thermistor open or short circuit is detected at power on or while running the compressor	
	Outdoor temperature thermistor		
Forecast of cause			Connector failure
			Thermistor failure
			Main PCB failure

Check point 1. Check connection of connector

- Check if connector is loose or removed.
- Check erroneous connection.
- Check if thermistor cable is open

-> Reset power when reinstalling due to removed connector or incorrect wiring.



Check point 2. Remove connector and check thermistor resistance value

- For the outdoor temperature thermistor resistance value, refer to "[Thermistor resistance values](#)" on page 03-88.
- If thermistor is either open or shorted, replace it and reset the power.

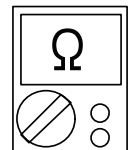

Check point 3. Check voltage of main PCB

Make sure circuit diagram of outdoor unit and check terminal voltage at thermistor (DC 5.0 V).

NOTE: For details of thermistor connector, refer to "[Wiring diagrams](#)" in Chapter 2. TECHNICAL DATA AND PARTS LIST on page 02-18.



If the voltage does not appear, replace main PCB.



End

2-22. E: 77.X. Heat sink thermistor error (Outdoor unit)

Indicator	Indoor unit	Operation indicator	7 time flash
		Timer indicator	7 time flash
		Economy indicator	Continuous flash
		Error code	E: 77
	outdoor unit	Refer to " Error code table (Outdoor unit) " on page 03-4	
Detective actuator	Heat sink temperature thermistor	Heat sink temperature thermistor short or open detected	
Forecast of cause		Connector failure	
		Thermistor failure	
		Inverter PCB failure	

Check point 1. Check connection of connector

- Check if connector is loose or removed.
- Check erroneous connection.
- Check if thermistor cable is open

-> Reset power when reinstalling due to removed connector or incorrect wiring.



Check point 2. Remove connector and check thermistor resistance value

- For the Heat sink thermistor resistance value, refer to "[Thermistor resistance values](#)" on page 03-88.
- If thermistor is either open or shorted, replace it and reset the power.

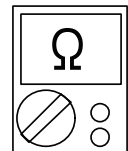

Check point 3. Check voltage of inverter PCB

Make sure circuit diagram of outdoor unit and check terminal voltage at thermistor (DC 5.0 V).

NOTE: For details of thermistor connector, refer to "[Wiring diagrams](#)" in Chapter 2. TECHNICAL DATA AND PARTS LIST on page 02-18.

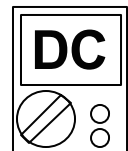

If the voltage does not appear, replace inverter PCB.



End

2-23. E: 84.X. Current sensor error (Outdoor unit)

Indicator	Indoor unit	Operation indicator	8 time flash
		Timer indicator	4 time flash
		Economy indicator	Continuous flash
		Error code	E: 84
	outdoor unit	Refer to " Error code table (Outdoor unit) " on page 03-4	
Detective actuator	Outdoor unit	main PCB	When input current sensor has detected 0 A, while inverter compressor is operating at higher than 56 rps, after 1 minute upon starting the compressor. (Except during the defrost operation)
Forecast of cause			Defective connection of electric components
			External cause
			Main PCB failure

Check point 1. Reset power supply and operate

Does error indication show again?

If no, go to "[Check point 1-2](#)".



Check point 2. Check connections of outdoor unit electrical components

- Check if the terminal connection is loose.
- Check if connector is removed.
- Check erroneous connection.
- Check if cable is open.

Upon correcting the removed connector or miswiring, reset the power.



Check point 3. Replace main PCB

If Check point 1, 2 do not improve the symptom, change main PCB.



End

Check point 1-2. Check external cause at Indoor and Outdoor (Voltage drop or Noise)

- Instant drop: Check if there is a large load electric apparatus in the same circuit.
- Momentary power failure: Check if there is a defective contact or leak current in the power supply circuit.
- Noise: Check if there is any equipment causing harmonic wave near electric line. (Neon bulb or electric equipment that may cause harmonic wave)
Check the complete insulation of grounding.



End

2-24. E: 86.X. High pressure switch error (Outdoor unit)

Indicator	Indoor unit	Operation indicator	8 time flash
		Timer indicator	6 time flash
		Economy indicator	Continuous flash
		Error code	E: 86
	outdoor unit	Refer to " Error code table (Outdoor unit) " on page 03-4	
Detective actuator	Outdoor unit main PCB	When pressure switch open is detected in 10 seconds after the power is turned on.	
	High pressure switch		
Forecast of cause	High pressure switch connector disconnection or open		
	High pressure switch characteristics failure		
	Main PCB failure		

Check point 1. Check the high pressure switch connection state

- Check connector and wiring connection state.
- Check if cable is open

-> Reset power when reinstalling due to removed connector or incorrect wiring.



Check point 2. Check the high pressure switch characteristics

- Check switch characteristics.
For the characteristics of the high pressure switch, refer to below.



Check point 3. Replace main PCB

Change main PCB and check operation again.



End

- Type of contact

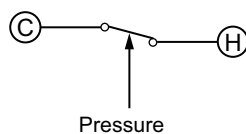

- Characteristics of pressure switch

Pressure switch 1	
Contact: Short → Open	4.2 ±0.1 MPa
Contact: Open → Short	3.2 ±0.15 MPa

18/24 model: P770

2-25. E: 86.X. Pressure sensor error (Outdoor unit)

Indicator	Indoor unit	Operation indicator	8 time flash
		Timer indicator	6 time flash
		Economy indicator	Continuous flash
		Error code	E: 86
	Outdoor unit	Refer to " Error code table (Outdoor unit) " on page 03-4	
Detective actuator	Outdoor unit main PCB	30 seconds or more after power-on, when pressure sensor detection value detects the condition below continuously for 30 seconds or more. $P_s \leq 0$ or $P_s \geq 5$ [MPa]	
	High pressure switch		
Forecast of cause			Connector connection failure
			Pressure sensor failure
			Main PCB failure

Check point 1. Check connection of the pressure sensor

- Check if the terminal connection is loose.
- Check if connector is removed.
- Check erroneous connection.
- Check if cable is open.

-> Upon correcting the removed connector or mis-wiring, reset the power.



Check point 2. Check output voltage of main PCB

Make sure circuit diagram of outdoor unit and check terminal voltage at thermistor (DC 5.0 V \pm 5%).

NOTE: For details of thermistor connector, refer to "[Wiring diagrams](#)" in Chapter 2. TECHNICAL DATA AND PARTS LIST on page 02-18.

If the voltage is not correct, replace main PCB.



Check point 3. Check output voltage of pressure sensor

Make sure circuit diagram of outdoor unit and check terminal voltage. Voltage is refer to the following graph.

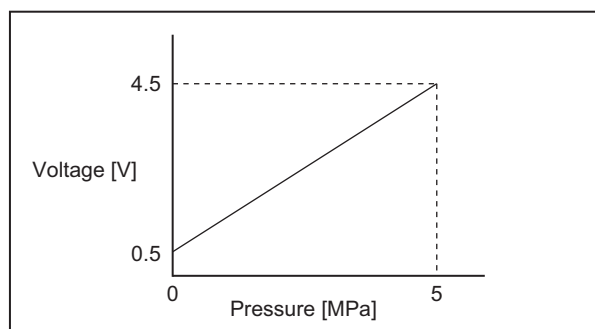

If the voltage is not correct, replace pressure sensor.



End

2-26. E: 94.X. Trip detection (Outdoor unit)

Indicator	Indoor unit	Operation indicator	9 time flash
		Timer indicator	4 time flash
		Economy indicator	Continuous flash
		Error code	E: 94
	outdoor unit	Refer to " Error code table (Outdoor unit) " on page 03-4	
Detective actuator	Outdoor unit	Inverter PCB	Protection stop by over-current generation after inverter compressor start processing completed generated consecutively 10 times. NOTE: The number of generations is reset when the compressor starts up.
		Main PCB	
		Compressor	
Forecast of cause			Outdoor unit fan operation defective, foreign matter on heat-exchanger, excessive rise of ambient temperature
			Main PCB failure
			Inverter compressor failure (lock, winding short)
			Inverter PCB

Check point 1. Check the outdoor unit fan operation, heat-exchanger, ambient temperature

- No obstructions in air passages?
- Heat exchange fins clogged
- Outdoor unit fan motor check
- Ambient temperature not raised by the effect of other heat sources?
- Discharged air not sucked in?



Check point 2. Replace inverter PCB

If Check point 1 do not improve the symptom, change inverter PCB.



Check point 3. Replace main PCB

If Check point 1, 2 do not improve the symptom, change main PCB.



Check point 4. Replace compressor

If Check point 3 do not improve the symptom, change compressor.



End

2-27. E: 95.X. Compressor motor control error (Outdoor unit)

Indicator	Indoor unit	Operation indicator	9 time flash
		Timer indicator	5 time flash
		Economy indicator	Continuous flash
		Error code	E: 95
	outdoor unit	Refer to " Error code table (Outdoor unit) " on page 03-4	
Detective actuator	Outdoor unit	Inverter PCB	<ol style="list-style-type: none"> When running the compressor, if the detected rotor location is out of phase with actual rotor location more than 90°, the compressor stops. After the compressor restarts, if the same operation is repeated within 40 seconds, the compressor stops again. If 1. and 2. repeats 5 times, the compressor stops permanently.
		Main PCB	
		Compressor	
Forecast of cause		Defective connection of electrical components	
		Inverter PCB failure	
		Main PCB failure	
		Compressor failure	

Check point 1. Check noise from compressor

Turn on power and check operation noise.
→ If an abnormal noise show, replace compressor.



Check point 2. Check connection of around the compressor components

For compressor terminal, main PCB

- Check if connector is removed.
- Check erroneous connection.
- Check if cable is open. (Refer to inverter compressor in "[Service parts information](#)" on page 03-80.)

→ Upon correcting the removed connector or mis-wiring, reset the power.



Check point 3. Replace inverter PCB

If Check point 1, 2 do not improve the symptom, change inverter PCB.



Check point 4. Replace main PCB

If Check point 1 to 3 do not improve the symptom, change main PCB.



Check point 5. Replace compressor

If Check point 4 do not improve the symptom, change compressor.



End

2-28. E: 97.X. Outdoor unit fan motor error (Outdoor unit)

Indicator	Indoor unit	Operation indicator	9 time flash
		Timer indicator	7 time flash
		Economy indicator	Continuous flash
		Error code	E: 97
	outdoor unit		Refer to " Error code table (Outdoor unit) " on page 03-4
Detective actuator	Outdoor unit	Inverter PCB	<ol style="list-style-type: none"> When outdoor fan rotation speed is less than 100 rpm in 20 seconds after fan motor starts, fan motor stops. After fan motor restarts, if the same operation within 60 seconds is repeated 3 times in a row, compressor and fan motor stops. If 1. and 2. repeats 5 times in a row, compressor and fan motor stops permanently.
		Main PCB	
		Fan motor	
Forecast of cause			Fan rotation failure
			Motor protection by surrounding temperature rise
			Inverter PCB failure
			Main PCB failure
			Outdoor unit fan motor

Check point 1. Check rotation of fan

Rotate the fan by hand when operation is off. (Check if fan is caught, dropped off or locked motor)
→ If fan or bearing is abnormal, replace it.



Check point 2. Check ambient temperature around motor

Check excessively high temperature around the motor. (If there is any surrounding equipment that causes heat)
→ Upon the temperature coming down, restart operation.



Check point 3. Check outdoor unit fan motor

Check outdoor unit fan motor. (Refer to outdoor unit fan motor in "[Service parts information](#)" on page 03-80.)
→ If outdoor unit fan motor is abnormal, replace outdoor unit fan motor and main PCB.



Check point 4. Check output voltage of inverter PCB

Check outdoor unit circuit diagram and the voltage. (Measure at inverter PCB side connector)

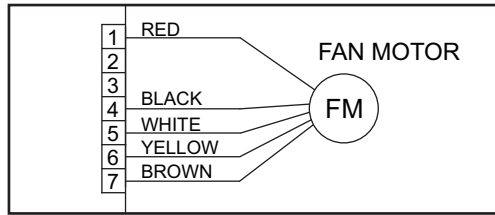

NOTE: For details of wiring diagram, refer to "[Wiring diagrams](#)" in Chapter 2. TECHNICAL DATA AND PARTS LIST on page 02-18.

Read wire	DC voltage
Red—Black	280 V (AC 220 V -10 %) to 373 V (AC 240 V +10 %)
White—Black	15±1.5 V

-> If the voltage is not correct, replace inverter PCB.



Check point 5. Replace main PCB

If Check point 1 to 4 do not improve the symptom, change main PCB.



End

2-29. E: 99.X. 4-way valve error (Outdoor unit)

Indicator	Indoor unit	Operation indicator	9 time flash
		Timer indicator	9 time flash
		Economy indicator	Continuous flash
		Error code	E: 99
	outdoor unit	Refer to " Error code table (Outdoor unit) " on page 03-4	
Detective actuator	Indoor unit	main PCB	When the indoor heat exchanger temperature is compared with the room temperature, and either following condition is detected continuously two times, the compressor stops. Indoor heat exchanger temp. - Room temp. > 20 °F (10 °C) (Cooling or Dry operation) Indoor heat exchanger temp. - Room temp. < -20 °F (-10 °C) (Heating operation) If the same operation is repeated 5 times, the compressor stops permanently.
	Heat exchanger temperature thermistor		
	Room temperature thermistor		
	4-way valve		
Forecast of cause	Air filter clogged		
	Connector connection failure		
	Thermistor failure		
	Coil failure		
	4-way valve failure		
	Main PCB failure		

Check point 1. Check air filter condition

Check air filter dirty.

→ If the air filter dirty, clean up the air filter.



Check point 2. Check connection of connector

- Check if connector is removed.
- Check erroneous connection.
- Check if thermistor cable is open.

→ Upon correcting the removed connector or mis-wiring, reset the power.



Check point 3. Check each thermistor

- Isn't it fallen off the holder?
- Is there a cable pinched?

Check characteristics of room thermistor and indoor unit heat exchanger thermistor.

For the thermistor resistance value, refer to "[Thermistor resistance values](#)" on page 03-88.

→ If defective, replace the thermistor.



Check point 4. Check the solenoid coil and 4-way valve

NOTE: Refer solenoid coil and 4-way valve in "[Service parts information](#)" on page 03-80.

- **Solenoid coil**
Remove P60 from PCB and check the resistance value of coil. Resistance value is 1.97 kΩ.
→ If it is open or abnormal resistance value, replace solenoid coil.
- **4-way valve**
Check each piping temperature, and the location of the valve by the temperature difference.
If the value location is not proper, replace 4-way valve.

**Check point 5. Replace main PCB**

If Check Point 1 to 4 do not improve the symptom, replace main PCB.



End

2-30. E: A1.X. Discharge temperature error (Outdoor unit)

Indicator	Indoor unit	Operation indicator	10 time flash
		Timer indicator	1 time flash
		Economy indicator	Continuous flash
		Error code	E: A1
	outdoor unit	Refer to " Error code table (Outdoor unit) " on page 03-4	
Detective actuator	Outdoor unit main PCB	Protection stop by discharge temperature ≥ 230 °F (110 °C) during compressor operation generated 2 times within 24 hours.	
	Discharge temperature thermistor		
Forecast of cause	3-way valve not opened		
	EEV or capillary tube defective, strainer clogged		
	Outdoor unit operation failure, foreign matter on heat exchanger		
	Discharge temperature thermistor failure		
	Insufficient refrigerant		
	Main PCB failure		

Check point 1. Check if 3-way valve is open

If the 3-way valve is closed, open the 3-way valve and check operation.

NOTE: For cooling operation, check gas side of the 3-way valve.

For heating operation, check liquid side of the 3-way valve.



Check point 2. Check any of the electronic expansion valve (EEV), capillary tube, or strainer, or all

- Check if EEV open or there is a capillary tube defect.
Refer to outdoor unit Electronic Expansion Valve (EEV) or Capillary tube in "[Service parts information](#)" on page 03-80.
- Check the strainer clogging.



Check point 3. Check the outdoor unit fan and heat exchanger

- Check for foreign object at heat exchanger
- Check if fan can be rotated by hand.
- Check the motor. (Refer to outdoor unit fan motor in "[Service parts information](#)" on page 03-80.)



Check point 4. Check the discharge thermistor

The discharge temperature thermistor characteristics check. (Check by disconnecting thermistor from PCB.)

NOTE: For the characteristics of the thermistor, refer to "[Thermistor resistance values](#)" on page 03-88.



Check point 5. Check the refrigerant amount

Check the refrigerant leakage.



Check point 6. Replace main PCB

If check point 1 to 5 do not improve the symptom, replace the main PCB.



End

2-31. E: A5.X. Low pressure error (Outdoor unit)

Indicator	Indoor unit	Operation indicator	10 time flash
		Timer indicator	5 time flash
		Economy indicator	Continuous flash
		Error code	E: A5
	outdoor unit	Refer to " Error code table (Outdoor unit) " on page 03-4	
Detective actuator	Outdoor unit main PCB		Protection stop by suction pressure ≥ 0.02 MPaG continued 5 minutes repeats 5 times within 24 hours.
	Suction pressure sensor		
Forecast of cause			3-way valve not opened
			Outdoor unit ambient temperature too low
			Outdoor unit operation failure, foreign matter on heat exchanger
			EEV defective, strainer clogged
			Solenoid valve defective
			Low pressure sensor characteristics defective
			Insufficient refrigerant
		Main PCB failure	

Check point 1. Check if 3-way valve is open

If the 3-way valve is closed, open the 3-way valve and check operation.

NOTE: For cooling operation, check gas side of the 3-way valve.
For heating operation, check liquid side of the 3-way valve.



Check point 2. Check the outdoor unit ambient temperature (Only when heating operation)

Outdoor unit ambient temperature lower than operating range?



Check point 3. Check the outdoor unit fan and heat exchanger (Only when heating operation)

- No foreign object in air passage?
- Heat exchanger fins clogged?
- Fan rotates?
- Check the motor. (Refer to outdoor unit fan motor in "[Service parts information](#)" on page 03-80.)



Check point 4. Check the electronic expansion valve (EEV) and strainer

- Check if EEV open.
Refer to outdoor unit Electronic Expansion Valve (EEV) in "[Service parts information](#)" on page 03-80.
- Check the strainer clogging.



Check point 5. Check the suction pressure sensor

Check the suction pressure sensor characteristics.

NOTE: For the characteristics of the thermistor, refer to suction pressure sensor in "[Service parts information](#)" on page 03-80.



Check point 6. Check the refrigerant amount

Check the refrigerant leakage.



Check point 7. Replace main PCB

If check point 1 to 6 do not improve the symptom, replace the main PCB.



End

2-32. E: AC.X. Heat sink temperature error (Outdoor unit)

Indicator	Indoor unit	Operation indicator	10 time flash
		Timer indicator	12 time flash
		Economy indicator	Continuous flash
		Error code	E: AC
	outdoor unit	Refer to " Error code table (Outdoor unit) " on page 03-4	
Detective actuator	Outdoor unit inverter PCB	Protection stop by heat sink temperature ≥ 176 °F (80 °C) during heat sink operation generated 2 times within 24 hours.	
	Heat sink temperature thermistor		
Forecast of cause	Foreign matter on heat sink, heat sink dirty		
	Foreign matter on heat exchanger, excessive ambient temperature rise		
	Heat sink temp. thermistor defective		

Check point 1. Check the heat sink state

Heat sink foreign matter, soiling check



Check point 2. Check the foreign matter and ambient temperature of heat exchanger

- Heat exchange foreign matter check
- Ambient temperature not raised by effect of other heat sources?
- Discharged air not sucked in?



Check point 3. Check the heat sink temperature thermistor

The heat sink temperature thermistor characteristics check. (Check by disconnecting thermistor from PCB.)

NOTE: For the characteristics of the thermistor, refer to "[Thermistor resistance values](#)" on page 03-88.



Check point 4. Replace inverter PCB

Replace inverter PCB



End

3. Troubleshooting without error code

3-1. Indoor unit—No power

Forecast of cause	Power supply failure
	External cause
	Electrical components defective

Check point 1. Check installation condition

- Isn't the breaker down?
- Check loose or removed connection cable.

-> If abnormal condition is found, correct it by referring to the installation manual or the "DESIGN & TECHNICAL MANUAL".



Check point 2. Check external cause at indoor and outdoor (voltage drop or noise)

- Instant drop: Check if there is a large load electric apparatus in the same circuit.
- Momentary power failure: Check if there is a defective contact or leak current in the power supply circuit.
- Noise: Check if there is any equipment causing harmonic wave near electric line. (Neon bulb or electric equipment that may cause harmonic wave)
Check the complete insulation of grounding.



Check point 3. Check electrical components

Check the voltage of power supply.

Check if AC 187 to 253 V appears at outdoor unit terminal L—N.

-> If no, go to "[Check point 1](#)" and "[Check point 2](#)".



- Check fuse in filter PCB.
If fuse is open, check if the wiring between terminal and filter PCB is loose, and replace fuse.
- Check varistor in filter PCB.
If varistor is defective, there is a possibility of an abnormal power supply.
Check the correct power supply and replace varistor.
Upon checking the normal power supply, replace varistor.



End

3-2. Outdoor unit—No power

Forecast of cause	Power supply failure
	External cause
	Electrical components defective

Check point 1. Check installation condition

- Is the circuit breaker on or off?
- Check loose or removed connection cable.

→ If abnormal condition is found, correct it by referring to the installation manual or the "DESIGN & TECHNICAL MANUAL".



Check point 2. Check external cause at indoor and outdoor (voltage drop or noise)

- Instant drop: Check if there is a large load electric apparatus in the same circuit.
- Momentary power failure: Check if there is a defective contact or leak current in the power supply circuit.
- Noise: Check if there is any equipment causing harmonic wave near electric line. (Neon bulb or electric equipment that may cause harmonic wave)
Check the complete insulation of grounding.



Check point 3. Check electrical components

Check the voltage of power supply.

Check if AC 198 to 264 V appears at outdoor unit terminal L—N

→ If no, go to "Check point 1" and "Check point 2".

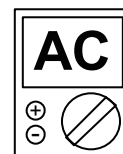

- Check fuse in main PCB.
If fuse is open, check if the wiring between terminal and main PCB is loose, and replace fuse.
- Check varistor in main PCB.
If varistor is defective, there is a possibility of an abnormal power supply. Check the correct power supply and replace varistor.
→ Upon checking the normal power supply, replace varistor.



Check point 4. Replace main PCB

If check point 1 to 3 do not improve the symptom, change main PCB.



End

3-3. No operation (Power is on)

Forecast of cause	Setting/ Connection failure
	External cause
	Electrical components defective

Check point 1. Check indoor and outdoor installation condition

- Indoor unit:
 - Check incorrect wiring between indoor unit and remote controller.
 - Check if there is an open cable connection.
 - Are these indoor unit, outdoor unit, and remote controller suitable model names to connect?
- > If there is some abnormal condition, correct it by referring to the installation manual and "DESIGN & TECHNICAL MANUAL".



Turn off the power and check correct followings.

- Is there loose or removed communication line of indoor unit and outdoor unit?



Check point 2. Check external cause at indoor and outdoor (Voltage drop or Noise)

- Instant drop: Check if there is a large load electric apparatus in the same circuit.
- Momentary power failure: Check if there is a defective contact or leak current in the power supply circuit.
- Noise: Check if there is any equipment causing harmonic wave near electric line. (Neon bulb or electric equipment that may cause harmonic wave)
Check the complete insulation of grounding.



Check point 3. Check wired remote controller and controller PCB

Check voltage at CN2 (terminal 1—3) of UTY-TWRXZ2 (Communication kit) (for 18 model). Check voltage at CN12 of main PCB (terminal 1—2) (for 24 model).
(Power supply to remote controller)

- If it is DC 5 V (for 18 model) and DC 12 V (for 24 model), remote controller is failure. (The controller PCB is normal)
-> Replace remote controller.
- If it is DC 0 V, controller PCB is failure. (Check the remote controller once again)
-> Replace controller PCB.



Check point 4. Replace main PCB

If check point 1 to 3 do not improve the symptom, change main PCB.



End

3-4. No cooling/No heating

Forecast of cause	Indoor unit error
	Outdoor unit error
	Effect by surrounding environment
	Connection pipe/Connection wire failure
	Refrigeration cycle failure

Check point 1. Check Indoor unit

- Does Indoor unit fan run in the HIGH mode?
- Is air filter dirty?
- Is heat exchanger clogged?
- Check if energy save function is operated.



Check point 2. Check outdoor unit operation

- Check if outdoor unit is operating.
- Check any objects that obstruct the air flow route.
- Check if heat exchanger is clogged.
- Is the valve open?



Check point 3. Check site condition

- Is capacity of Indoor unit fitted to the room size?
- Any windows open or direct sunlight?



Check point 4. Check Indoor/ Outdoor installation condition

- Check connection pipe (specified pipe length and pipe diameter?)
- Check any loose or removed communication line.

→ If there is an abnormal condition, correct it by referring to the installation manual or the "DESIGN & TECHNICAL MANUAL".



Check point 5. Check Refrigeration cycle

- Check if strainer is clogged (Refer to the figure below).
- Measure gas pressure, and if there is a leakage, correct it.
- Check if EEV open or there is a capillary tube defect.
Refer to outdoor unit Electronic Expansion Valve (EEV) or Capillary tube in "[Service parts information](#)" on page 03-80.
- Check compressor.
Refer to compressor in "[Service parts information](#)" on page 03-80.
Refer to inverter compressor in "[Service parts information](#)" on page 03-80.

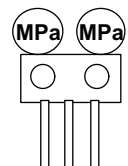

NOTE: When recharging the refrigerant, make sure to perform vacuuming, and recharge the specified amount.



End

NOTES:

- Strainer normally does not have temperature difference between inlet and outlet as shown below.

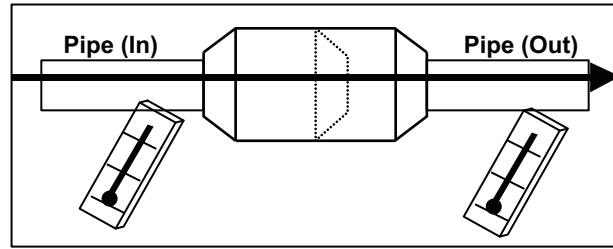

- If there is a difference like shown below, there is a possibility of inside clogged. In this case, replace the strainer.

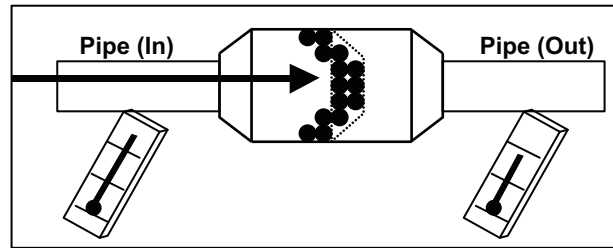

3-5. Abnormal noise

Forecast of cause	Abnormal installation (indoor unit/outdoor unit)
	Fan failure (indoor unit/outdoor unit)
	Compressor failure (outdoor)

Diagnosis method when abnormal noise is occurred

Abnormal noise is coming from Indoor unit.
(Check and correct followings)



- Is main unit installed in stable condition?
- Is the installation of air suction grille and front panel normal?



- Is fan broken or deformed?
- Is the screw of fan loose?
- Is there any object which obstruct the fan rotation?



End

Abnormal noise is coming from Outdoor unit.
(Check and correct followings)



- Is main unit installed in stable condition?
- Is fan guard installed normally?



- Is fan broken or deformed?
- Is the screw of fan loose?
- Is there any object which obstruct the fan rotation?



Check if vibration noise by loose bolt or contact noise of piping is happening.



Is compressor locked?

- Check Compressor
Refer to compressor and inverter compressor in "[Service parts information](#)" on page 03-80.



End

3-6. Water leaking

Forecast of cause

Erroneous installation

Drain hose failure

Diagnosis method when water leak occurs

- Is main unit installed in stable condition?
- Is main unit broken or deformed at the time of transportation or maintenance?



- Is drain hose connection loose?
- Is there a trap in drain hose?
- Is drain hose clogged?



Is fan rotating?



End

Diagnosis method when water is spitting out

Is the filter clogged?



Check gas pressure and correct it if there was a gas leak.

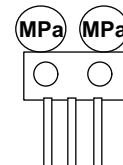

End

3-7. Too warm

Forecast of cause	House insulation setting has not been changed.
	Temperature sensing location has not been changed.
	Installation location of the wired remote.
	Function settings have not been changed.

Check point 1. Check insulation level of structure of house

Is insulation level greater than R-13?

→ If no, go to "Check Point 4".



Check point 2. Check function setting

If insulation level is greater than R-13 set function 95 to 01.

NOTE: For details of function setting number 95, refer to "Function settings (Indoor unit)" in Chapter 5. FIELD WORKING on page 05-1.



Check Point 3. Check effects of function setting change

Is the space still too warm in relation to setpoint?



Check Point 4. Verify room temperature sensing location

Do you want room temperature sensed at the wired remote controller (Wired remote sensor) or by they build in sensor inside the unit (Indoor unit sensor)?

→ If indoor unit sensor, go to "Check Point 5".

→ If wired remote sensor, go to "Check point 8".

Check Point 5. Check the remote controller display

Is the "Thermo Sensor Icon" displayed on the screen?

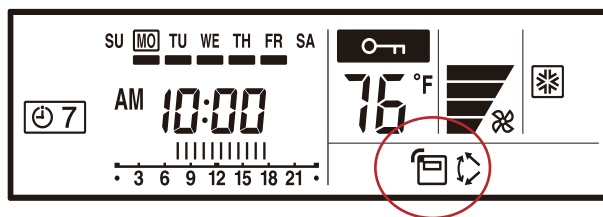

→ If no, go to "Check point 7".



Check point 6. Check the remote controller

Hold down the THERMO SENSOR button until the thermo sensor icon is turned off.

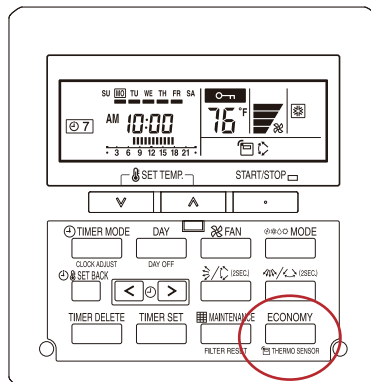

→ If the space is still too warm, go to "Check point 7".



End

Check point 7. Check function settings

Using the table on the right adjust function 31. (Room Temperature Control for indoor unit sensor)

NOTE: For details of function setting number 31, refer to "Function settings (Indoor unit)" in Chapter 5. FIELD WORKING on page 05-1.



End

Check point 8. Check the remote controller display

Is the "Thermo Sensor Icon" displayed on the screen?

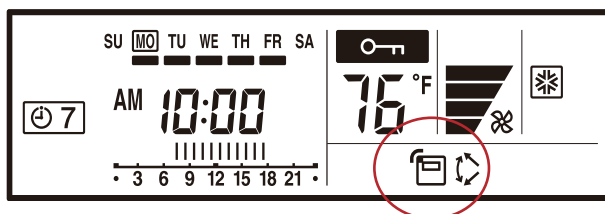

→ If no, go to "Check point 8-1".



Check point 9. Check the function Setting

Is function 48 (Room temperature sensor switching) set to 01?

→ If no, go to "Check point 9-1".



Check point 10. Location of the remote controller

Is the mounting location of the wired remote controller affecting the temperature sensing? (Sunlight on the remote, heat source next to the remote)

→ If no, go to "Check point 12".



Check point 11. Location of the remote controller

Move the remote controller.

→ If the space is still too warm, go to "Check point 12".



End

Check point 8-1. Check function setting

Is function 42 (Indoor room temperature sensor switching function) set to 01?

NOTE: For details of function setting number 42, refer to "Function settings (Indoor unit)" in Chapter 5. FIELD WORKING on page 05-1.



Check point 8-2. Check the remote controller

Press and hold down the THERMO SENSOR button to turn on the icon.

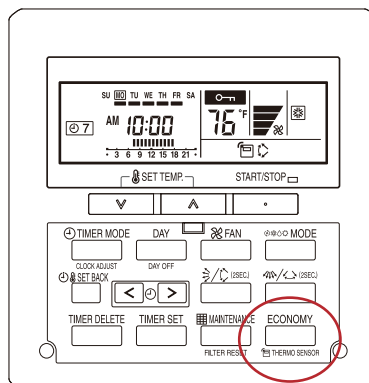

→ If the space is still too warm, go to "Check point 9".



End

Check point 9-1. Check function setting

Change setting of function 48 (Room temperature sensor switching) to 01.

NOTE: For details of function setting number 48, refer to "[Function settings \(Indoor unit\)](#)" in Chapter 5. FIELD WORKING on page 05-1.

**Check point 9-2. Check the effects of function setting change**

Did this function setting improve temperature control?

→ If the space is still too warm, go to "[Check point 10](#)".



End

Check point 12. Check function setting

Using the table on the right adjust temperature correction by changing function setting 36. (Room Temperature control for wired remote controller sensor)

NOTE: For details of function setting number 36, refer to "[Function settings \(Indoor unit\)](#)" in Chapter 5. FIELD WORKING on page 05-1.



End

3-8. Too cool

Forecast of cause	House insulation setting has not been changed.
	Temperature sensing location has not been changed.
	Installation location of the wired remote.
	Function settings have not been changed.

Check point 1. Check insulation level of structure of house

Is insulation level greater than R-13?

→ If no, go to "Check Point 4".



Check point 2. Check function setting

If insulation level is greater than R-13 set function 95 to 01.

NOTE: For details of function setting number 95, refer to "Function settings (Indoor unit)" in Chapter 5. FIELD WORKING on page 05-1.



Check Point 3. Check effects of function setting change

Is the space still too cool in relation to setpoint?



Check Point 4. Verify room temperature sensing location

Do you want room temperature sensed at the wired remote controller (Wired remote sensor) or by they build in sensor inside the unit (Indoor unit sensor)?

→ If indoor unit sensor, go to "Check Point 5".

→ If wired remote sensor, go to "Check point 8".

Check Point 5. Check the remote controller display

Is the "Thermo Sensor Icon" displayed on the screen?

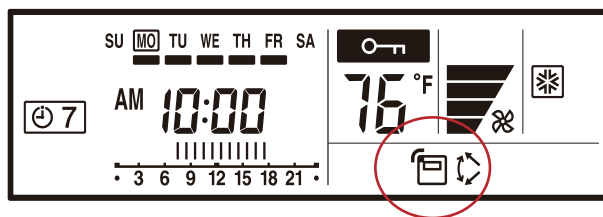

→ If no, go to "Check point 7".



Check point 6. Check the remote controller

Hold down the THERMO SENSOR button until the thermo sensor icon is turned off.

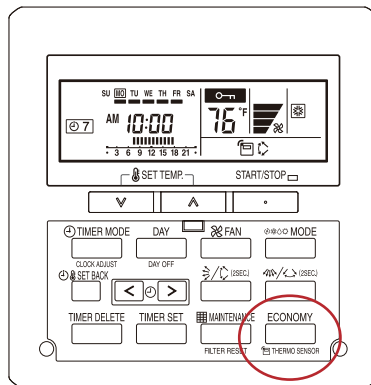

→ If the space is still too cool, go to "Check point 7".



End

Check point 7. Check function settings

Using the table on the right adjust function 30. (Room Temperature Control for indoor unit sensor)

NOTE: For details of function setting number 30, refer to "Function settings (Indoor unit)" in Chapter 5. FIELD WORKING on page 05-1.



End

Check point 8. Check the remote controller display

Is the "Thermo Sensor Icon" displayed on the screen?

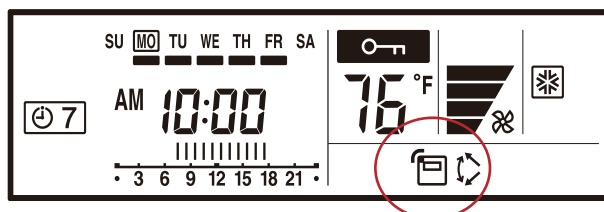

→ If no, go to "Check point 8-1".



Check point 9. Check the function Setting

Is function 48 (Room temperature sensor switching) set to 01?

→ If no, go to "Check point 9-1".



Check point 10. Location of the remote controller

Is the mounting location of the wired remote controller affecting the temperature sensing? (Sunlight on the remote, heat source next to the remote)

→ If no, go to "Check point 12".



Check point 11. Location of the remote controller

Move the remote controller.

→ If the space is still too cool, go to "Check point 12".



End

Check point 8-1. Check function setting

Is function 42 (Indoor room temperature sensor switching function) set to 01?

NOTE: For details of function setting number 42, refer to "Function settings (Indoor unit)" in Chapter 5. FIELD WORKING on page 05-1.



Check point 8-2. Check the remote controller

Press and hold down the THERMO SENSOR button to turn on the icon.

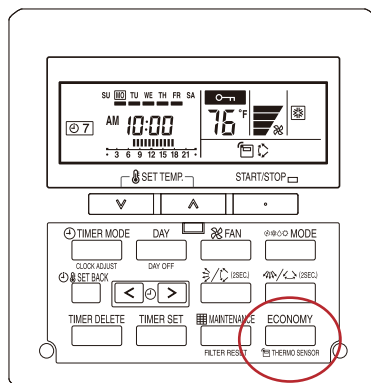

→ If the space is still too cool, go to "Check point 9".



End

Check point 9-1. Check function setting

Change setting of function 48 (Room temperature sensor switching) to 01.

NOTE: For details of function setting number 48, refer to "[Function settings \(Indoor unit\)](#)" in Chapter 5. FIELD WORKING on page 05-1.

**Check point 9-2. Check the effects of function setting change**

Did this function setting improve temperature control?

→ If the space is still too cool, go to "[Check point 10](#)".



End

Check point 12. Check function setting

Using the table on the right adjust temperature correction by changing function setting 35. (Room Temperature control for wired remote controller sensor)

NOTE: For details of function setting number 35, refer to "[Function settings \(Indoor unit\)](#)" in Chapter 5. FIELD WORKING on page 05-1.



End

4. Troubleshooting with error code (For wireless LAN adapter)

4-1. E: 18.X. External communication error between indoor unit and WLAN adapter

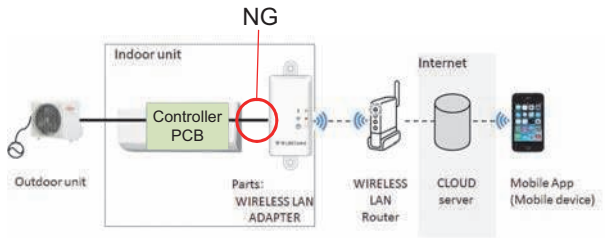
Indicator	Indoor unit	Operation indicator	1 time flash
		Timer indicator	8 time flash
		Economy indicator	Continuous flash
		Error code	E: 18
	Wireless LAN adapter	LED1 (green)	Flashing fast
		LED2 (orange)	On
Detective actuator	Wireless LAN adapter PCB	After receiving a signal from the wireless LAN adapter, the same signal has not been received for 15 seconds.	
	Controller PCB		
Forecast of cause	Connection between indoor unit and wireless LAN adapter failure		
	Wireless LAN adapter PCB failure		
	Controller PCB failure		

Check point 1. Check the connection

- Check any loose or removed connection of between the wireless LAN adapter PCB and controller PCB.
-> If there is abnormal condition, correct it.
- Check the connection condition on the controller PCB.
-> If there is loose connector, open cable or mis-wiring, correct it.



Check point 2. Replace wireless LAN adapter.

If check point 1 do not improve the symptom, replace the wireless LAN adapter and cancel the registration of air conditioner on the mobile app.

After replacing the adapter, perform the pairing on the mobile app.

For the method of the mobile app, refer to "[Mobile app setting method](#)" on page 03-75.



Check point 3. Replace controller PCB

If check point 1 to 2 do not improve the symptom, replace the controller PCB.



End

4-2. Wireless LAN adapter error

Indicator	Indoor unit	Operation indicator	No indication
		Timer indicator	No indication
		Economy indicator	No indication
		Error code	—
	Wireless LAN adapter	LED1 (green)	Flashing fast
		LED2 (orange)	Flashing fast
Detective actuator	Wireless LAN adapter setting button	When the setting button becomes on for consecutive 60 seconds or more. 	
	Wireless LAN adapter PCB		
Forecast of cause		Wireless LAN adapter setting button failure	Wireless LAN adapter PCB failure

Check point 1. Check the setting button

Check if setting button is kept pressed.

-> If the setting button is held down by the foreign matter, remove the foreign matter or remove the cause of the button press.



Check point 2. Replace wireless LAN adapter.

If check point 1 do not improve the symptom, replace the wireless LAN adapter and cancel the registration of air conditioner on the mobile app.

After replacing the adapter, perform the pairing on the mobile app.

For the method of the mobile app, refer to "[Mobile app setting method](#)" on page 03-75.



Check point 3. Replace controller PCB

If check point 1 to 2 do not improve the symptom, replace the Wireless LAN adapter.



End

4-3. Network communication error between wireless LAN router and WLAN adapter

Indicator	Indoor unit	Operation indicator	No indication
		Timer indicator	No indication
		Economy indicator	No indication
		Error code	—
	Wireless LAN adapter	LED1 (green)	On
		LED2 (orange)	Flashing fast
Detective actuator	Wireless LAN router	When the not connection between wireless LAN adapter and wireless LAN router.	
	Wireless LAN adapter PCB		
Forecast of cause	Connection cable failure of wireless LAN router		
	Connection between wireless LAN adapter and wireless LAN router failure		
	Wireless LAN router failure		
	Wireless LAN adapter PCB failure		

Check point 1. Check the connection cable

Check the connection cable on the wireless LAN router.

-> If there is loose connector, open cable or mis-wiring, correct it.



Check point 2. Check the connection status.

Check the connection status to the internet and wireless LAN router.

-> If the wireless LAN router is not connected to the internet, check the transmission between wireless LAN products (ex. PC or game console, etc.) other than air conditioner and wireless LAN router.

If no, go to "[Check point 2-2](#)".



Check point 3. Turn on the power again of air conditioner.

If check point 1 to 2 do not improve the symptom, turn on the power of the air conditioner again and wait for 60 seconds.



Check point 4. Replace wireless LAN adapter.

If check point 3 do not improve the symptom, replace the wireless LAN adapter and cancel the registration of air conditioner on the mobile app.

After replacing the adapter, perform the pairing on the mobile app.

For the method of the mobile app, refer to "[Mobile app setting method](#)" on page 03-75.



End

Check point 2-2. Check the transmission state

Check the wireless transmission state of the wireless LAN router (LED status).

-> If the wireless transmission from the wireless LAN router has not been outgoing, inquire to the wireless LAN router maker.



End

4-4. E: 18.X. Communication error

Indicator	Indoor unit	Operation indicator	1 time flash
		Timer indicator	8 time flash
		Economy indicator	Continuous flash
		Error code	E: 18
	Wireless LAN adapter	LED1 (green)	Flashing fast
		LED2 (orange)	Flashing fast
Detective actuator	Wireless LAN router	When the external communication error between indoor unit and WLAN adapter and network communication error between wireless LAN router and WLAN adapter has occurred simultaneously.	
	Wireless LAN adapter PCB		
	Indoor unit controller PCB		
Forecast of cause	Connection cable failure of wireless LAN router		
	Wireless LAN router failure		
	Connection between indoor unit and wireless LAN adapter failure		
	Connection between wireless LAN adapter and wireless LAN router failure		
	Wireless LAN adapter PCB failure		
	Controller PCB failure		

Check point 1. Check the connection cable

Check the connection cable on the wireless LAN router.

-> If there is loose connector, open cable or mis-wiring, correct it.



Check point 2. Check the connection status and transmission state

- Check the connection status to the internet and wireless LAN router.
-> If the wireless LAN router is not connected to the internet, check the transmission between wireless LAN products (ex. PC or game console, etc.) other than air conditioner and wireless LAN router.
If no, go to "[Check point 4](#)".
- Check the wireless transmission state of wireless LAN router (LED status).
-> If the wireless transmission from the wireless LAN router has not been outgoing, inquire to wireless LAN router maker.

If the display pattern is changed as follows, go to "[Check point 3-2](#)".

- LED 1 (green): flashing fast
- LED 2 (orange): on

If no, go to "[Check point 3-1](#)".



Check point 3-1. Turn on the power again of air conditioner.

If check point 1 to 2 do not improve the symptom, turn on the power of the air conditioner again and wait for 60 seconds.

-> When the flashing pattern of the LED 2 (orange) is on, go to ["Check point 3-2"](#).

-> When the flashing pattern of the LED 2 (orange) is flashing fast, go to ["Check point 4"](#).

**Check point 3-2. Check the connection.**

- Check any loose or removed connection of between the wireless LAN adapter PCB and controller PCB.
-> If there is abnormal condition, correct it.
- Check the connection condition on the controller PCB.
-> If there is loose connector, open cable or mis-wiring, correct it.

**Check point 4. Replace wireless LAN adapter.**

If check point 2 to 3 do not improve the symptom, replace the wireless LAN adapter and cancel the registration of air conditioner on the mobile app.

After replacing the adapter, perform the pairing on the mobile app.

For the method of the mobile app, refer to ["Mobile app setting method"](#) on page 03-75.

**Check point 5. Replace controller PCB**

If check point 4 do not improve the symptom, replace the controller PCB.



End

4-5. E: 18.X. Wireless LAN adapter non-energized

Indicator	Indoor unit	Operation indicator	1 time flash
		Timer indicator	8 time flash
		Economy indicator	Continuous flash
		Error code	E: 18
	Wireless LAN adapter	LED1 (green)	Off
LED2 (orange)		Off	
Detective actuator	Indoor unit controller PCB	When the voltage (DC 12 V) does not output from the controller PCB.	
	Wireless LAN adapter PCB		
Forecast of cause		Indoor unit controller PCB failure	
		Wireless LAN adapter PCB failure	
		Wiring connection failure	

Check point 1. Check the connection.

- Check any loose or removed connection of between the wireless LAN adapter PCB and controller PCB.
-> If there is abnormal condition, correct it.
- Check the connection condition on the controller PCB.
-> If there is loose connector, open cable or mis-wiring, correct it.



Check point 2. Check the wireless LAN adapter PCB and the controller PCB

Check voltage at CN6 (terminal 1—2) of main PCB.

(Power supply to remote controller)

- If it is DC 0 V, controller PCB is failure.
-> Replace controller PCB.
- If it is DC 12 V, wireless LAN adapter PCB is failure.
-> Replace the wireless LAN adapter and cancel the registration of air conditioner on the mobile app.

After replacing the adapter, perform the pairing on the mobile app.

For the method of the mobile app, refer to "[Mobile app setting method](#)" on page 03-75.



End

4-6. Wireless LAN adapter Sleep mode (Indoor unit)

Indicator	Indoor unit	Operation indicator	No indication
		Timer indicator	No indication
		Economy indicator	No indication
		Error code	—
	Wireless LAN adapter	LED1 (green)	Off
LED2 (orange)		Off	
Detective actuator	Sleep mode	When the state in which fly a wireless(SSID) have passed 1 hour.	
Forecast of cause		Sleep mode	

Check point 1. Cheak the sleep mode

Press the Wireless LAN adapter setting button the 3 seconds or more.

-> If the display pattern is changed as follows, refer to "[Network communication error between wireless LAN router and WLAN adapter](#)" on page 03-69.

- LED 1 (green): on
- LED 2 (orange): flashing fast

4-7. Mobile app setting method

■ Air conditioner deregistration method

When the wireless LAN adapter is replaced, deregistration of all air conditioner is necessary on the mobile app.

1. Launch the mobile app.



2. Press and hold the registered device name of the air conditioner.

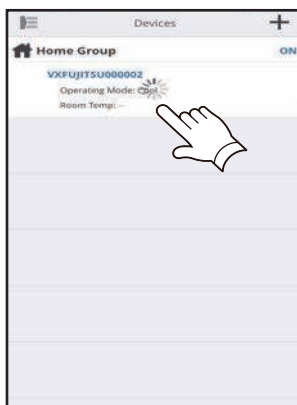

3. If the Unregister button is displayed, tap the button.

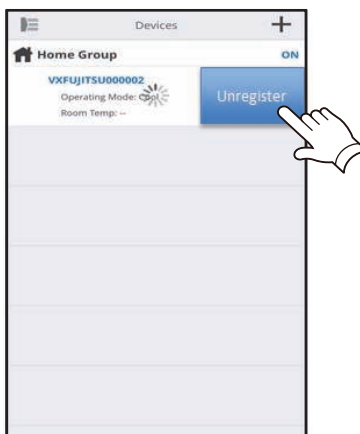

4. Tap the Yes button.

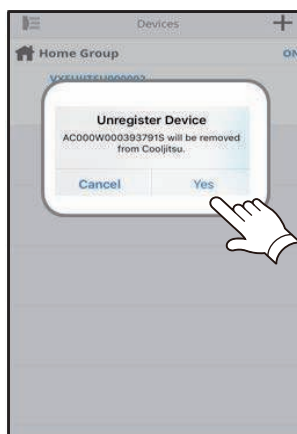

5. Deregistration of the air conditioner is completed.

■ Air conditioner registration pairing method

Choose the following modes to connect the air conditioner to the wireless LAN router.

NOTES:

- Before starting this setting, wait for 60 seconds or more after the power supply is connected to the air conditioner (via breaker or plug).
- Check that the smartphone or tablet PC is linked to the wireless router to be connected to the air conditioner.
The setting does not work if the same wireless LAN router is not connected.
- The displayed screen design may differ depending on the version of the mobile app.
- To control 2 or more air conditioners with the same smartphone or tablet PC, repeat the setup of the chosen mode.

Light pattern: ○ Off ● On ● Flashing

● Button mode

1. Launch the mobile app.



2. Sign in with your e-mail address and password following the screen on the mobile app.

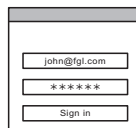

3. Press the + button to add a new air conditioner.



4. Confirm that the LED 2 blinks (on/off at 2 seconds intervals). Then select Button mode on the screen. If the LED 1 and 2 are off, push the setting button once.

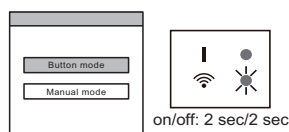

5. Press the WPS button on the wireless LAN router to be connected.
For the button location of the wireless LAN router and how to press it, refer to the operation manual of the wireless LAN router.

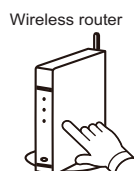

6. Confirm that the LED 2 blinks (on/off at 2 seconds intervals). Then press and hold the setting button on the WLAN Adapter for 3 seconds.

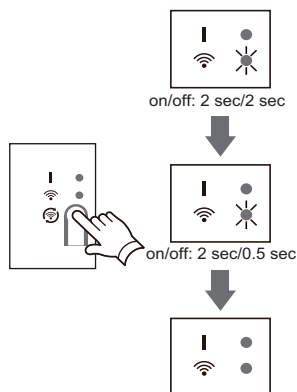

The light pattern of the LED 2 changes. (On/off: 2 sec./2 sec. → 2 sec./0.5 sec.)
Confirm both of the LED 1 and 2 are on to proceed.

7. Press Register button to start the connection with the wireless LAN router.

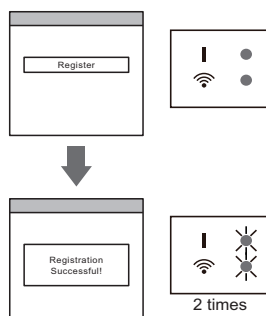

Both of the LED 1 and 2 flash 2 times and a message appear when the setup is completed.

● Manual mode (For Android)

1. Launch the mobile app.



2. Sign in with your e-mail address and password following the screen on the mobile app.



3. Press the + button to add a new air conditioner.



4. Select manual mode.

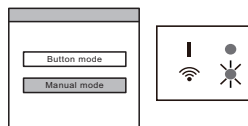

If both of the LED 1 and 2 are off, push the setting button once.

5. Select the SSID of the air conditioner to be connected.

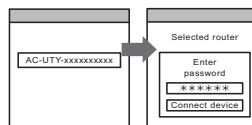

Input the PIN code written on the wireless LAN label.

6. Select the SSID of the wireless LAN router to be connected.

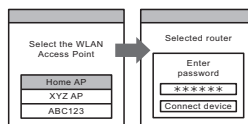

Input the wireless LAN router (wireless LAN access point) password then press Connect device button.

7. When setup is completed, both of the LED 1 and 2 flash 2 times, and a message appear.

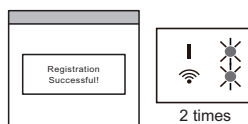

● Manual mode (For iOS)

1. Launch the mobile app.



2. Sign in with your e-mail address and password following the screen on the mobile app.

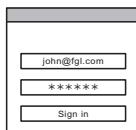

3. Press the + button to add a new air conditioner.

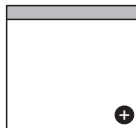

4. Select manual mode.

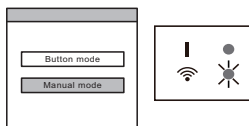

If both of the LED 1 and 2 are off, push the setting button once.

5. Select Open W-LAN setting button or activate the wireless LAN by pressing the Home button → Setting button → Wi-Fi button.

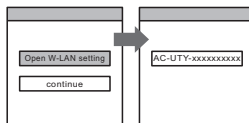

Select the SSID of the air conditioner to be connected.

6. Input the PIN code written on the wireless LAN label.

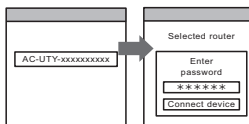

7. Select the SSID of the wireless LAN router to be connected.
Input the wireless LAN router (wireless LAN access point) password then press Connective device button.

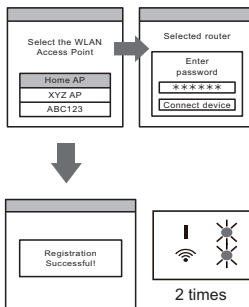

When setup is completed, both of the LED 1 and 2 flash 2 times and a message appear.

5. Service parts information

5-1. Compressor

Diagnosis method of compressor (If outdoor unit LED displays error, refer to troubleshooting)

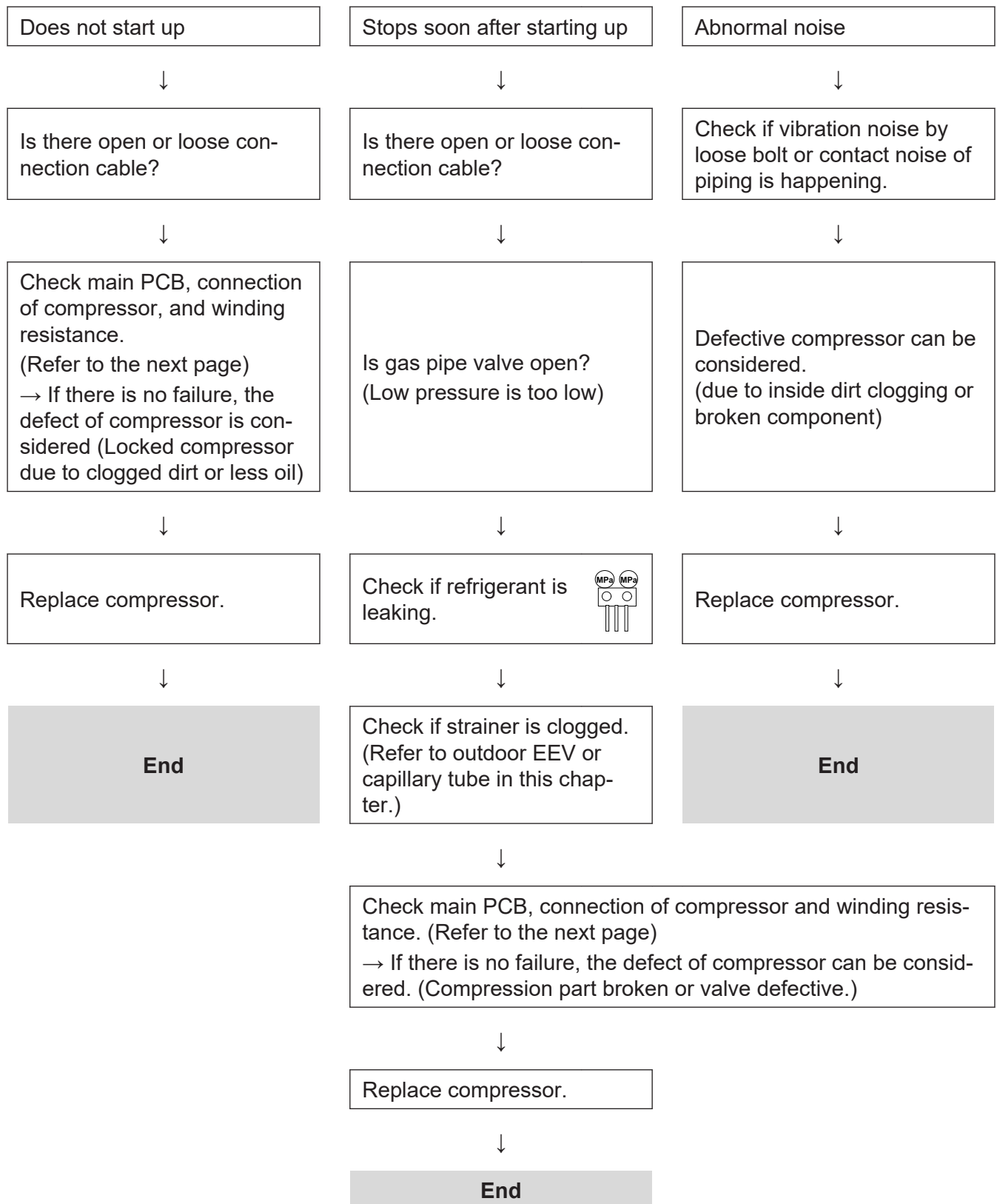

5-2. Inverter compressor

Check point 1. Check connection

- Check terminal connection of compressor (loose or incorrect wiring)

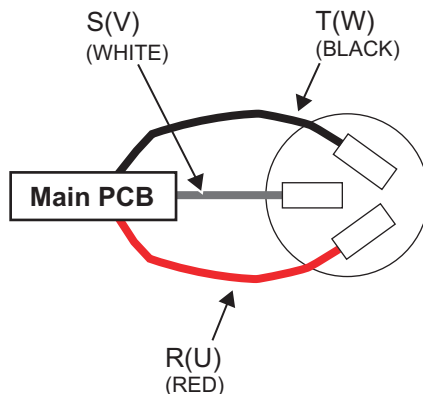

- Check terminal connection of main PCB (loose or incorrect wiring)

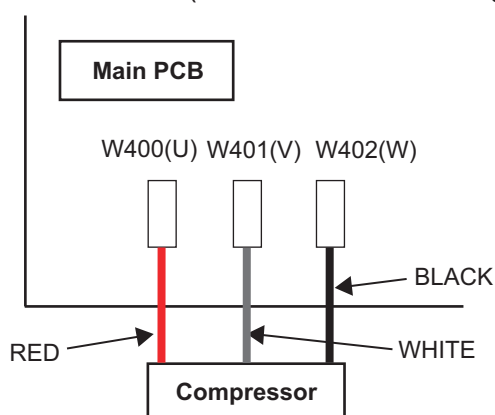

↓

Check point 2. Check winding resistance

Check winding resistance of each terminal.

Resistance value: $1.160 \Omega \pm 8\%$ 68 °F (20 °C)

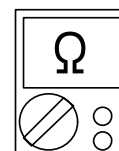
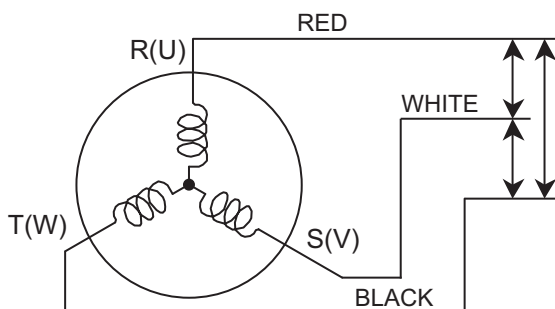

→ If the resistance value is 0 Ω or infinite, replace compressor.

↓

Check point 3. Replace inverter PCB

If check point 1 to 2 do not improve the symptom, replace main PCB.

5-3. Outdoor unit Electronic Expansion Valve (EEV)

Check point 1. Check connections

Check connection of connector. (Loose connector or open cable)

NOTE: For details of wiring diagram, refer to "Wiring diagrams" in Chapter 2. TECHNICAL DATA AND PARTS LIST on page 02-18.

Check point 2. Check coil of EEV

Remove connector, check each winding resistance of coil.

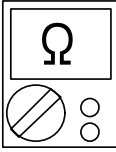
Read wire	Resistance value
1(Red) - 2(Blue)	$46 \Omega \pm 3 \Omega$ at 68 °F (20 °C) 
1(Red) - 3(Orange)	
1(Red) - 4(Yellow)	
1(Red) - 5(White)	

→ If Resistance value is abnormal, replace EEV.

Check point 3. Check Voltage from main PCB

Remove connector and check voltage (DC 12 V)

→ If it does not appear, replace main PCB.



Check point 4. Check noise at start up

Turn on the power and check the operation noise.

→ If an abnormal noise does not show, replace main PCB.

Check point 5. Check Opening and Closing Operation of Valve

When valve is closed, it has a temp. difference between inlet and outlet

CLOSE
 Example : Hot Gas

Pipe (In)
 Hi TEMP.

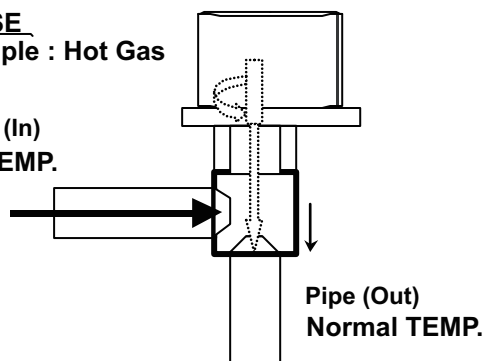

If it is open, it has no temp. difference between inlet and outlet

OPEN
 Example : Hot Gas

Pipe (In)
 Hi TEMP.

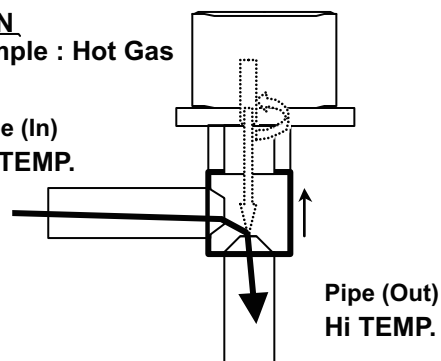

Check point 6. Check strainer

- Strainer normally does not have temperature difference between inlet and outlet as shown below.

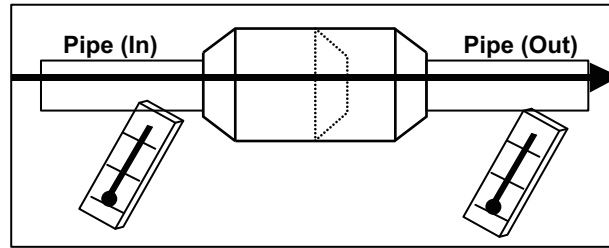

- If there is a difference like shown below, there is a possibility of inside clogged. In this case, replace the strainer.

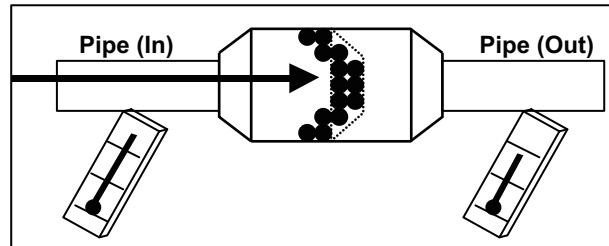

5-4. Indoor unit fan motor

Check point 1. Check rotation of fan

Rotate the fan by hand when operation is off.
 (Check if fan is caught, dropped off or locked motor)
 → If fan or bearing is abnormal, replace it.

Check point 2. Check resistance of indoor fan motor

Refer to below. Circuit-test “Vm” and “GND” terminal

NOTE: Vm: DC voltage, GND: Earth terminal

→ If they are short-circuited (below 300 k Ω), replace indoor fan motor and controller PCB.

Pin number (wire color)	Terminal function (symbol)
1 (Red)	DC voltage (Vm)
2	No function
3	No function
4 (Black)	Earth terminal (GND)
5 (White)	Control voltage (Vcc)
6 (Yellow)	Speed command (Vsp)
7 (Blue)	Feed back (FG)

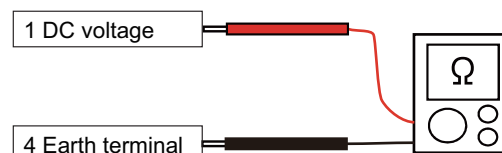

5-5. Outdoor unit fan motor

Check point 1. Check rotation of fan

Rotate the fan by hand when operation is off.
 (Check if fan is caught, dropped off or locked motor)
 → If fan or bearing is abnormal, replace it.

Check point 2. Check resistance of outdoor fan motor

Refer to below. Circuit-test “Vm” and “GND” terminal

NOTE: Vm: DC voltage, GND: Earth terminal

→ If they are short-circuited (below 300 kΩ), replace outdoor fan motor and controller PCB.

Pin number (wire color)	Terminal function (symbol)
1 (Red)	DC voltage (Vm)
2	No function
3	No function
4 (Black)	Earth terminal (GND)
5 (White)	Control voltage (Vcc)
6 (Yellow)	Speed command (Vsp)
7 (Brown)	Feed back (FG)

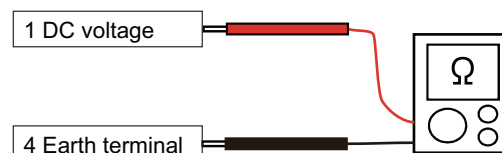

5-6. Pressure switch

- Type of contact

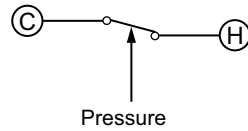

- Characteristics of pressure switch

Pressure switch 1	
Contact: Short → Open	4.2 — 4.05 MPa
Contact: Open → Short	3.2 ± 0.15 MPa

18/24 model: P770

5-7. 4-way valve coil (solenoid coil)/4-way valve

Check point 1. Check connection

- Check the connection of connector P60.

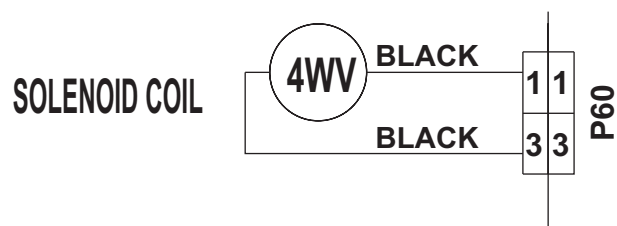

↓

Check Point 2 : Check solenoid coil

Remove P60 from PCB and check the resistance value of coil.

Resistance Value $\approx 1.97 \text{ k}\Omega$

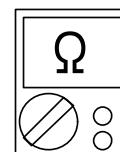

→ If it is Open or abnormal resistance value, replace solenoid coil.

↓

Check Point 3: Check operation of 4-way valve

Check each piping temperature, and confirm the location of the valve by the temperature difference

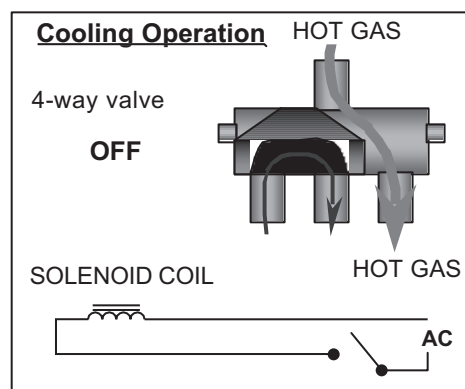
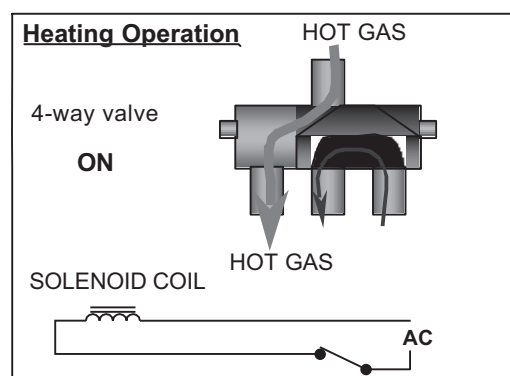

→ If the valve location is not proper, replace 4-way valve.

↓

Check Point 4: Replace main PCB

If none of Checks 1 to 3 apply, replace the main PCB.

6. Thermistor resistance values

6-1. Indoor unit

■ Room temperature thermistor

Temperature °F (°C)	Resistance (kΩ)	Voltage (V)
14.0 (-10.0)	58.25	0.73
23.0 (-5.0)	44.03	0.93
32.0 (0.0)	33.62	1.15
41.0 (5.0)	25.93	1.39
50.0 (10.0)	20.18	1.66
59.0 (15.0)	15.84	1.94
68.0 (20.0)	12.54	2.22
77.0 (25.0)	10.00	2.50
86.0 (30.0)	8.04	2.77
95.0 (35.0)	6.51	3.03
104.0 (40.0)	5.30	3.27
113.0 (45.0)	4.35	3.49

■ Heat exchanger temperature thermistor

Temperature °F (°C)	Resistance (kΩ)	Voltage (V)
-22.0 (-30.0)	1,131.91	0.21
-13.0 (-25.0)	804.52	0.29
-4.0 (-20.0)	579.59	0.40
5.0 (-15.0)	422.89	0.53
14.0 (-10.0)	312.27	0.69
23.0 (-5.0)	233.21	0.88
32.0 (0.0)	176.03	1.10
41.0 (5.0)	134.23	1.36
50.0 (10.0)	103.34	1.63
59.0 (15.0)	80.28	1.92
68.0 (20.0)	62.91	2.21
77.0 (25.0)	49.70	2.51
86.0 (30.0)	39.57	2.79
95.0 (35.0)	31.74	3.06
104.0 (40.0)	25.64	3.30
113.0 (45.0)	20.85	3.53
122.0 (50.0)	17.06	3.73
131.0 (55.0)	14.05	3.90
140.0 (60.0)	11.64	4.05
149.0 (65.0)	9.69	4.19

6-2. Outdoor unit

■ Discharge temperature thermistor

Temperature °F (°C)	Resistance (kΩ)	Voltage (V)
-22.0 (-30.0)	1,013.11	0.06
-12.0 (-25.0)	729.09	0.09
-4.0 (-20.0)	531.56	0.12
5.0 (-15.0)	392.31	0.16
14.0 (-10.0)	292.91	0.21
23.0 (-5.0)	221.09	0.28
32.0 (0.0)	168.60	0.36
41.0 (5.0)	129.84	0.46
50.0 (10.0)	100.91	0.57
59.0 (15.0)	79.12	0.71
68.0 (20.0)	62.55	0.86
77.0 (25.0)	49.84	1.03
86.0 (30.0)	40.01	1.23
95.0 (35.0)	32.35	1.43
104.0 (40.0)	26.34	1.65
113.0 (45.0)	21.58	1.88
122.0 (50.0)	17.79	2.11
131.0 (55.0)	14.75	2.34
140.0 (60.0)	12.30	2.57
149.0 (65.0)	10.32	2.79
158.0 (70.0)	8.69	3.00
167.0 (75.0)	7.36	3.19
176.0 (80.0)	6.27	3.37
185.0 (85.0)	5.36	3.54
194.0 (90.0)	4.60	3.69
203.0 (95.0)	3.96	3.83
212.0 (100.0)	3.43	3.96
221.0 (105.0)	2.98	4.07
230.0 (110.0)	2.60	4.17
239.0 (115.0)	2.27	4.26
248.0 (120.0)	2.00	4.33

■ Compressor temperature thermistor

Temperature °F (°C)	Resistance (kΩ)	Voltage (V)
-22.0 (-30.0)	1,013.11	0.06
-12.0 (-25.0)	729.09	0.09
-4.0 (-20.0)	531.56	0.12
5.0 (-15.0)	392.31	0.16
14.0 (-10.0)	292.91	0.21
23.0 (-5.0)	221.09	0.28
32.0 (0.0)	168.60	0.36
41.0 (5.0)	129.84	0.46
50.0 (10.0)	100.91	0.57
59.0 (15.0)	79.12	0.71
68.0 (20.0)	62.55	0.86
77.0 (25.0)	49.84	1.03
86.0 (30.0)	40.01	1.23
95.0 (35.0)	32.35	1.43
104.0 (40.0)	26.34	1.65
113.0 (45.0)	21.58	1.88
122.0 (50.0)	17.79	2.11
131.0 (55.0)	14.75	2.34
140.0 (60.0)	12.30	2.57
149.0 (65.0)	10.32	2.79
158.0 (70.0)	8.69	3.00
167.0 (75.0)	7.36	3.19
176.0 (80.0)	6.27	3.37
185.0 (85.0)	5.36	3.54
194.0 (90.0)	4.60	3.69
203.0 (95.0)	3.96	3.83
212.0 (100.0)	3.43	3.96
221.0 (105.0)	2.98	4.07
230.0 (110.0)	2.60	4.17
239.0 (115.0)	2.27	4.26
248.0 (120.0)	2.00	4.33

■ Heat exchanger temperature thermistor

Temperature °F (°C)	Resistance (kΩ)	Voltage (V)
-22.0 (-30.0)	95.57	0.24
-12.0 (-25.0)	68.89	0.32
-4.0 (-20.0)	50.31	0.43
5.0 (-15.0)	37.19	0.57
14.0 (-10.0)	27.81	0.73
23.0 (-5.0)	21.02	0.92
32.0 (0.0)	16.05	1.14
41.0 (5.0)	12.38	1.39
50.0 (10.0)	9.63	1.65
59.0 (15.0)	7.56	1.93
68.0 (20.0)	5.98	2.21
77.0 (25.0)	4.77	2.49
86.0 (30.0)	3.84	2.77
95.0 (35.0)	3.11	3.02
104.0 (40.0)	2.53	3.26
113.0 (45.0)	2.08	3.48
122.0 (50.0)	1.71	3.67
131.0 (55.0)	1.42	3.85
140.0 (60.0)	1.19	4.00
149.0 (65.0)	1.00	4.13
158.0 (70.0)	0.84	4.25
167.0 (75.0)	0.71	4.35
176.0 (80.0)	0.61	4.43

■ Heat exchanger (Middle) temperature thermistor

Temperature °F (°C)	Resistance (kΩ)	Voltage (V)
-22.0 (-30.0)	95.57	0.24
-12.0 (-25.0)	68.89	0.32
-4.0 (-20.0)	50.31	0.43
5.0 (-15.0)	37.19	0.57
14.0 (-10.0)	27.81	0.73
23.0 (-5.0)	21.02	0.92
32.0 (0.0)	16.05	1.14
41.0 (5.0)	12.38	1.39
50.0 (10.0)	9.63	1.65
59.0 (15.0)	7.56	1.93
68.0 (20.0)	5.98	2.21
77.0 (25.0)	4.77	2.49
86.0 (30.0)	3.84	2.77
95.0 (35.0)	3.11	3.02
104.0 (40.0)	2.53	3.26
113.0 (45.0)	2.08	3.48
122.0 (50.0)	1.71	3.67
131.0 (55.0)	1.42	3.85
140.0 (60.0)	1.19	4.00
149.0 (65.0)	1.00	4.13
158.0 (70.0)	0.84	4.25
167.0 (75.0)	0.71	4.35
176.0 (80.0)	0.61	4.43

■ Outdoor temperature thermistor

Temperature °F (°C)	Resistance (kΩ)	Voltage (V)
-22.0 (-30.0)	224.33	0.73
-12.0 (-25.0)	159.71	0.97
-4.0 (-20.0)	115.24	1.25
5.0 (-15.0)	84.21	1.56
14.0 (-10.0)	62.28	1.90
23.0 (-5.0)	46.58	2.26
32.0 (0.0)	35.21	2.61
41.0 (5.0)	26.88	2.94
50.0 (10.0)	20.72	3.25
59.0 (15.0)	16.12	3.52
68.0 (20.0)	12.64	3.76
77.0 (25.0)	10.00	3.97
86.0 (30.0)	7.97	4.14
95.0 (35.0)	6.40	4.28
104.0 (40.0)	5.18	4.41
113.0 (45.0)	4.21	4.51
122.0 (50.0)	3.45	4.59
131.0 (55.0)	2.85	4.65

4. CONTROL AND FUNCTIONS

CONTENTS

4. CONTROL AND FUNCTIONS

1. Rotation number control of compressor.....	04-1
1-1. Cooling operation	04-1
1-2. Heating operation	04-3
1-3. Dry operation	04-3
1-4. Rotation number of compressor at normal start-up	04-4
1-5. Rotation number of compressor limitation by outdoor temperature	04-5
2. Auto changeover operation.....	04-7
3. Fan control.....	04-9
3-1. Indoor fan control.....	04-9
3-2. Outdoor fan control.....	04-12
4. Louver control	04-14
4-1. Horizontal louver control	04-14
4-2. Vertical louver control	04-14
4-3. Swing operation.....	04-15
5. Timer operation control	04-16
5-1. Wireless remote control	04-16
5-2. Wired remote control	04-18
6. Defrost operation control	04-21
6-1. Defrost operation in heating operation stopped	04-22
7. Various control	04-23
7-1. Auto restart.....	04-23
7-2. MANUAL AUTO operation.....	04-23
7-3. Forced cooling operation	04-24
7-4. MIN. HEAT operation	04-24
7-5. ECONOMY operation	04-24
7-6. POWERFUL operation	04-25
7-7. Fresh air control.....	04-25
7-8. Compressor preheating	04-25
7-9. External electrical heater control	04-26
7-10. Electronic expansion valve control	04-26
7-11. Prevention to restart for 3 minutes (3 minutes st)	04-26
7-12. 4-way valve control.....	04-26
7-13. Peak cut operation	04-27
7-14. Unit status monitoring and the detected value indication	04-27
8. Various protections.....	04-30
8-1. Discharge gas temperature over-rise prevention control	04-30
8-2. Anti-freezing control (cooling and dry mode)	04-30
8-3. Current release control	04-31
8-4. Compressor temperature protection	04-31
8-5. High pressure protection	04-31

CONTENTS (continued)

8-6. Low outdoor temperature protection	04-32
8-7. High temperature and high pressure release control	04-32

1. Rotation number control of compressor

1-1. Cooling operation

A sensor (room temperature thermistor) built in the indoor unit body will usually perceive difference or variation between a set temperature and present room temperature, and controls the operation rotation number of the compressor.

- If the room temperature is 11 °F (6.0 °C) higher than a set temperature, the operation rotation number of compressor will attain to maximum performance.
- If the room temperature is 2 °F (1.0 °C) lower than a set temperature, the compressor will be stopped.
- When the room temperature is within the range of +11 °F (6.0 °C) to -2 °F (1.0 °C) of the setting temperature, the rotation number of compressor is controlled within the range shown in the table below. However, the maximum rotation number is limited in the range shown in the figure below based on the indoor fan mode and the outdoor temperature.

- **Rotation number range of compressor**

Unit: rps

Model name	Minimum frequency	Maximum frequency
ASUH18LMAS	10	63
ASUH24LMAS	10	80

• Limit of maximum speed based on outdoor temperature

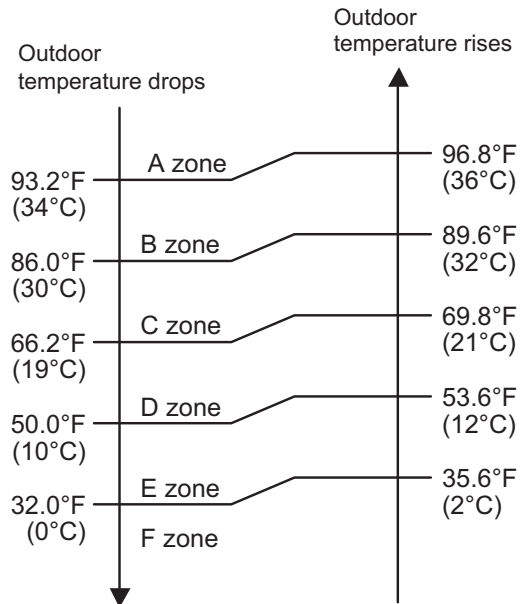

Unit: rps

Model name	Outdoor temperature zone	Indoor unit fan mode			
		HIGH	MED	LOW	QUIET
ASUH18LMAS	A zone	63	34	26	18
	B zone	63	34	26	18
	C zone	63	34	26	18
	D zone	39	39	32	28
	E zone	39	39	32	28
	F zone	39	39	32	28
ASUH24LMAS	A zone	80	68	58	46
	B zone	80	68	58	46
	C zone	80	68	58	46
	D zone	58	54	50	46
	E zone	58	54	50	46
	F zone	54	54	50	46

CONTROL AND FUNCTIONS

CONTROL AND FUNCTIONS

1-2. Heating operation

A sensor (room temperature thermistor) built in indoor unit body will usually perceive difference or variation between setting temperature and present room temperature, and controls operation rotation number of compressor.

- If the room temperature is 11 °F (6.0 °C) lower than a set temperature, the operation rotation number of compressor will attain to maximum performance.
- If the room temperature is 2 °F (1.0 °C) higher than a set temperature, the compressor will be stopped.
- When the room temperature is within the range of +2 °F (1.0°C) to -11 °F (6.0°C) of the setting temperature, the rotation number of compressor is controlled within the range shown below.

- **Rotation number range of compressor**

Unit: rps

Model name	Minimum frequency	Maximum frequency
ASUH18LMAS	10	130
ASUH24LMAS		

1-3. Dry operation

The rotation number of compressor shall change according to the temperature, set temperature, and room temperature variation which the room temperature sensor of the indoor unit has detected as shown in the table below.

Zone is defined by set temperature and room temperature.

- **Rotation number range of compressor**

Unit: rps

Model name	Outdoor temperature zone	Operating frequency
ASUH18LMAS	X zone	22
	J zone	18
	Y zone	0
ASUH24LMAS	X zone	46
	J zone	24
	Y zone	0

- **Compressor control based on room temperature**

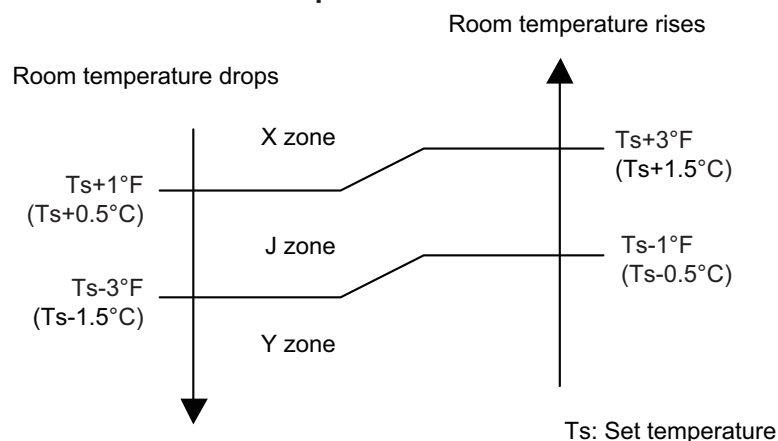

1-4. Rotation number of compressor at normal start-up

Compressor frequency soon after starting is controlled as below.

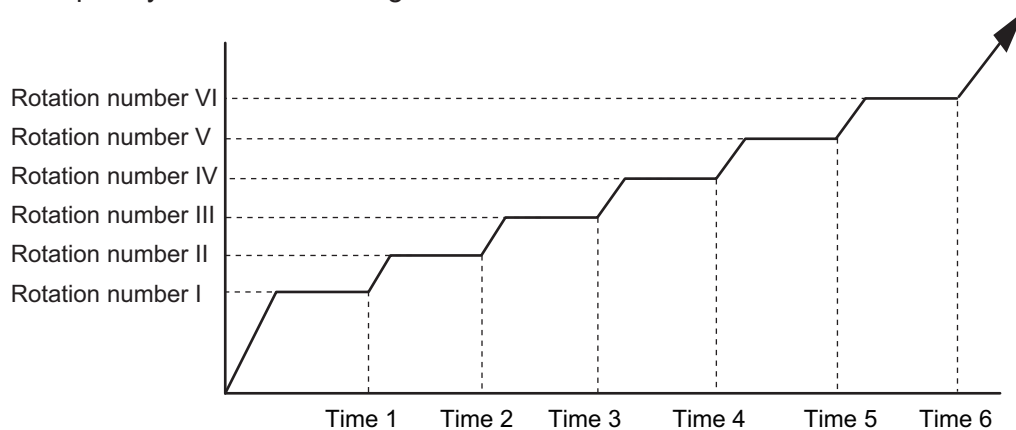

Frequency (rps)	I 35	II 52	III 64	IV 71	V 89	VI 97
Time (sec)	1 60	2 140	3 170	4 200	5 350	6 410

CONTROL AND FUNCTIONS

CONTROL AND FUNCTIONS

1-5. Rotation number of compressor limitation by outdoor temperature

The minimum rotation number of compressor is limited by outdoor temperature as below.

- **Cooling/Dry mode**

107.6°F (42°C)	K zone
100.4°F (38°C)	J zone
87.8°F (31°C)	I zone
69.8°F (21°C)	H zone
55.4°F (13°C)	G zone
44.6°F (7°C)	F zone
35.6°F (2°C)	E zone
23.0°F (-5°C)	D zone
14.0°F (-10°C)	C zone
5.0°F (-15°C)	B zone
	A zone

Model name	Outdoor temperature zone	Limitation of compressor frequency
AOUH18LMAS1	A zone	55 rps
	B zone	50 rps
	C zone	36 rps
	D zone	34 rps
	E zone	30 rps
	F zone	26 rps
	G zone	19 rps
	H zone	19 rps
	I zone	21 rps
	J zone	24 rps
	K zone	29 rps
AOUH24LMAS1	A zone	60 rps
	B zone	55 rps
	C zone	52 rps
	D zone	45 rps
	E zone	36 rps
	F zone	28 rps
	G zone	21 rps
	H zone	19 rps
	I zone	21 rps
	J zone	24 rps
	K zone	29 rps

- Heating mode

68.0°F (20°C)	G zone
44.6°F (7°C)	F zone
35.6°F (2°C)	E zone
19.4°F (-7°C)	D zone
14.0°F (-10°C)	C zone
5.0°F (-15°C)	B zone
	A zone

Model name	Outdoor temperature zone	Limitation of compressor frequency
AOUH18LMAS1 AOUH24LMAS1	A zone	71 rps
	B zone	53 rps
	C zone	44 rps
	D zone	39 rps
	E zone	29 rps
	F zone	23 rps
	G zone	21 rps

2. Auto changeover operation

When the air conditioner is set to AUTO mode by remote controller, operation starts in the optimum mode from among heating, cooling, dry and monitoring modes. During operation, the optimum mode is automatically switched in accordance with temperature changes. The temperature can be set between 64.4°F (18°C) and 86.0°F (30°C) in 1.8°F (1.0°C) steps.

- When operation starts, indoor fan and outdoor fan are operated for around 1 minute. Room temperature and outdoor temperature are sensed, and the operation mode is selected in accordance with the table below.

Room temperature	Operation mode
$Tr > Ts + 3.6^{\circ}\text{F}$ (2°C)	Cooling
$Ts + 3.6^{\circ}\text{F}$ (2°C) $\geq Tr \geq Ts - 3.6^{\circ}\text{F}$ (2°C)	Middle zone
$Tr < Ts - 3.6^{\circ}\text{F}$ (2°C)	Heating

Tr: Room temperature

Ts: Setting temperature

NOTE: When the operation mode is middle zone, indoor unit operation mode is selected as below.

- Same operation mode is selected as outdoor unit.
If outdoor unit is operating in cooling and heating mode, indoor unit will be operated by the same operation mode.
- Selected by outdoor temperature.
If outdoor unit is operating in other than cooling and heating mode, indoor unit will be operated according to the outdoor temperature as below.

Outdoor temp.	Operation mode
77.0°F (25°C) or more	Cooling
Less than 77.0°F (25°C)	Heating

- When the compressor was stopped for 6 consecutive minutes by temperature control function after the cooling or heating mode was selected as above, operation is switched to monitoring mode and the operation mode selection is done again.
- When the middle zone is selected on the predetermining of the operation mode, the operation mode before the changing to the monitoring mode is selected.

Operation flow chart

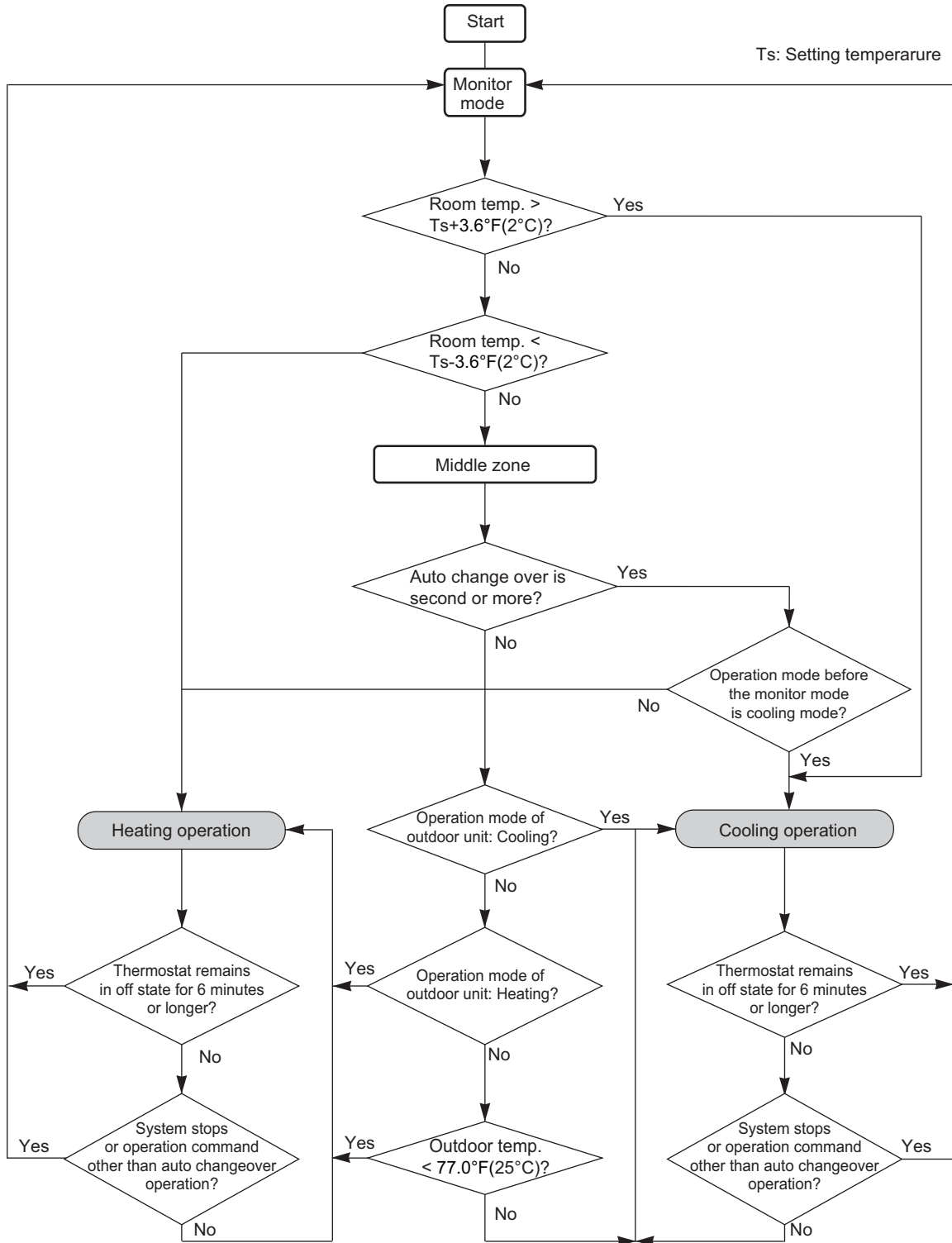

CONTROL AND FUNCTIONS

CONTROL AND FUNCTIONS

3. Fan control

Tr: Room temperature

Ts: Setting temperature

3-1. Indoor fan control

■ Fan speed

Indoor fan speed is defined as below.

Operation mode	Fan mode	Speed (rpm)	
		AOUH18LMAS1	AOUH24LMAS1
Heating	POWERFUL	1,490	1,280
	HIGH	1,390	1,180
	MED+	1,320	1,040
	MED	1,210	900
	LOW	960	770
	QUIET	810	680
	Cool air prevention	680	550
Cooling/Fan	POWERFUL	1,460	1,160
	HIGH	1,360	1,060
	MED	1,180	900
	LOW	960	770
	QUIET	810	680
	Soft quiet	680* ¹	550* ¹
	S-LOW	540* ²	450* ²
Dry		X zone: 860 J zone: 810	X zone: 680 J zone: 640

*1: Fan mode only

*2: Cooling mode only

■ Fan operation

Airflow can be switched in 5 steps such as AUTO, QUIET, LOW, MED, HIGH while indoor unit fan only runs.

When fan mode is set at AUTO, it operates on MED fan speed.

■ Cooling operation

Switch the airflow AUTO, and indoor fan motor will run according to room temperature, as below.

On the other hand, if switched in HIGH—QUIET, indoor motor will run at a constant airflow of COOL operation modes QUIET, LOW, MED, HIGH as shown in “Fan speed” above.

Airflow change over (Cooling: Auto)

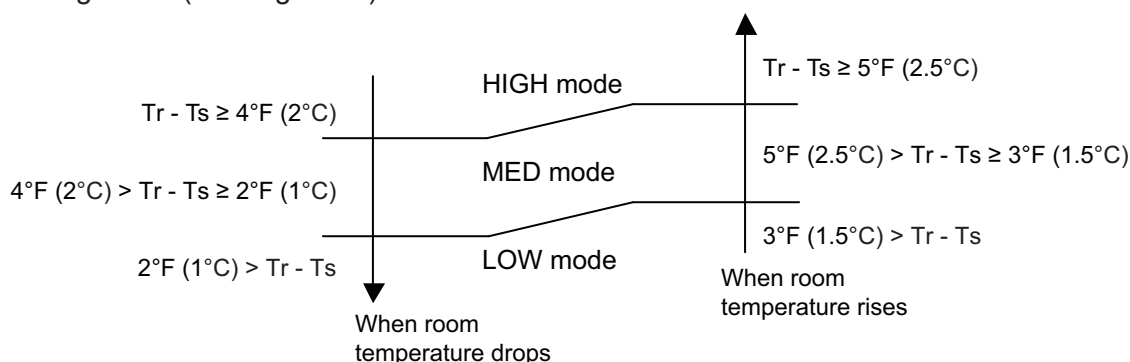

■ Dry operation

During dry operation, fan speed setting can not be changed as shown in “Fan speed” above.

■ Heating operation

Switch the airflow AUTO, and the indoor fan motor will run according to a room temperature, as below.

On the other hand, if switched in HIGH—QUIET, the indoor motor will run at a constant airflow of HEAT operation modes QUIET, LOW, MED, HIGH as shown in “Fan speed” above.

Airflow change over (Heating: Auto)

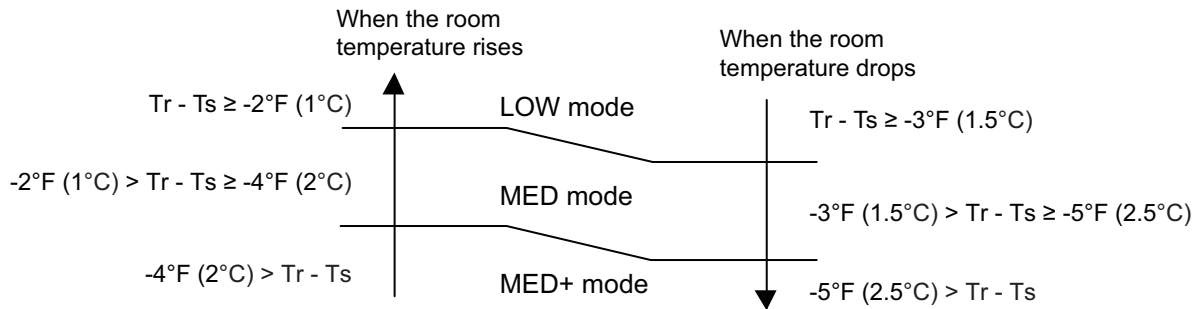

■ Cool air prevention control (heating mode)

The maximum value of the indoor fan speed is set as shown below, based on the detected temperature by the indoor heat exchanger sensor on heating mode.

• Normal operation

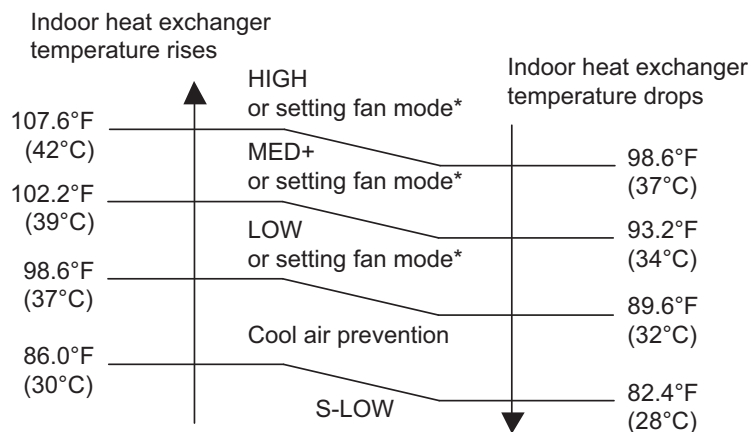

*: Lower speed is selected.

7 minutes later:

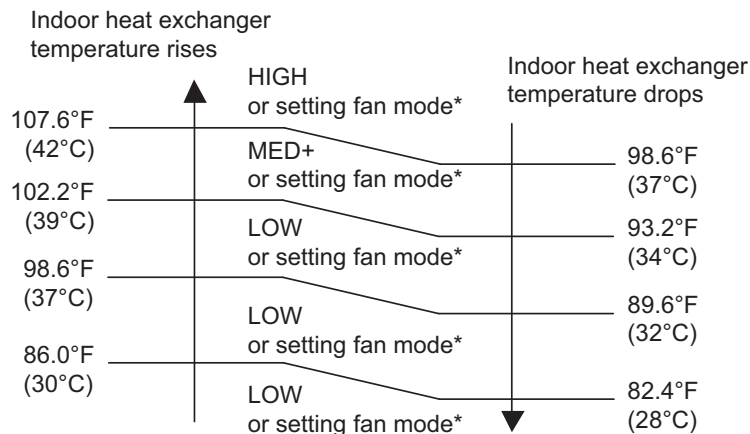

*: Lower speed is selected.

• **Powerful operation**

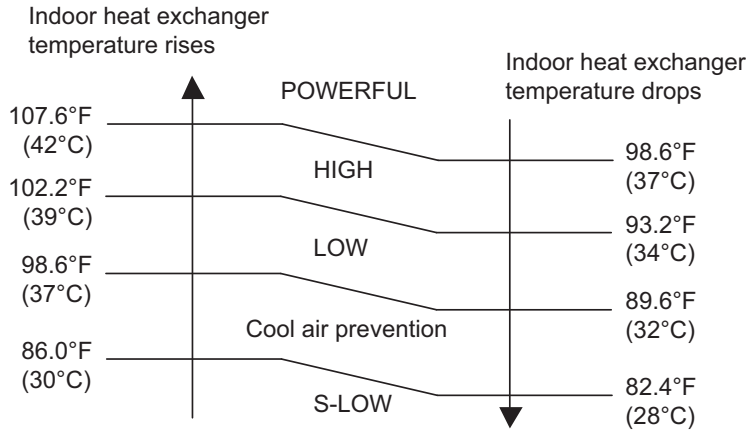

7 minutes later:

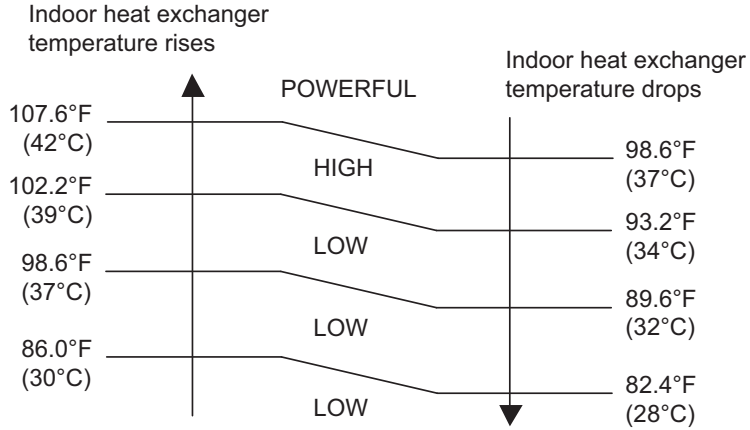

• **MIN. HEAT operation**

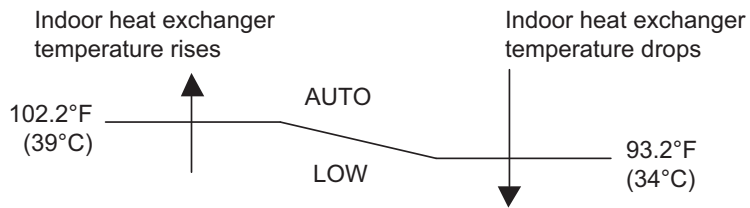

■ **Moisture return prevention control (cooling and dry mode)**

Switch the airflow AUTO at cooling mode, and the indoor fan motor will run as shown below.

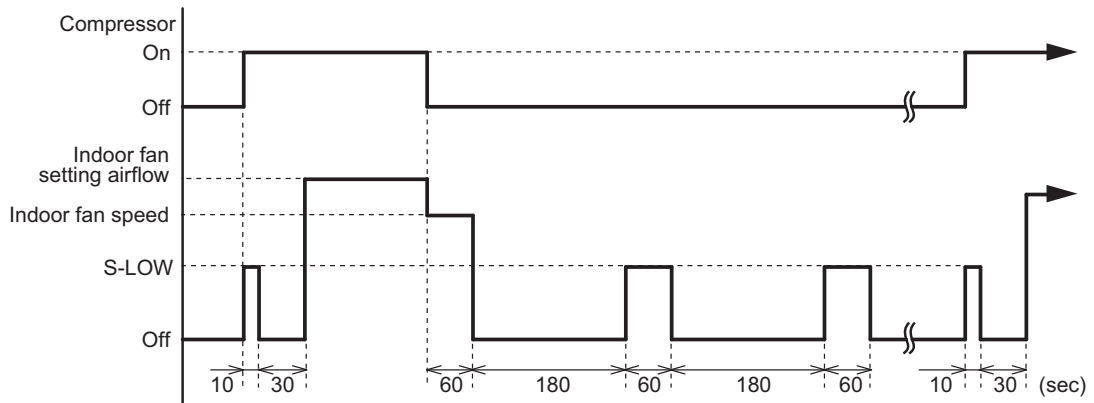

3-2. Outdoor fan control

■ Outdoor fan motor

This outdoor unit has a DC fan motor. (Control method is different between AC and DC motors.)

■ Fan speed

● AOUH18LMAS1

Fan speed is defined by outdoor temperature and compressor frequency.

Unit: rpm

Fan step	Cooling or dry	Heating
13	830	—
12	830	—
11	740	—
10	700	830
9	650	740
8	570	670
7	570	620
6	540	590
5	510	480
4	480	410
3	480	340
2	400	270
1	200	200
S-HIGH	—	830

- When the compressor frequency increases, the outdoor fan speed also changes to the higher speed.
- When the compressor frequency decreases, the outdoor fan speed also changes to the lower speed.

NOTE: After defrost control on the heating mode, the fan speed is kept higher regardless of the compressor frequency.

Fan speed after defrost control: 830 rpm

● AOUH24LMAS1

Fan speed is defined by outdoor temperature and compressor frequency.

Unit: rpm

Fan step	Cooling or dry	Heating
13	830	—
12	830	—
11	740	—
10	700	830
9	650	740
8	570	690
7	570	620
6	540	590
5	510	480
4	480	410
3	480	340
2	400	270
1	200	200
S-HIGH	—	830

- When the compressor frequency increases, the outdoor fan speed also changes to the higher speed.
- When the compressor frequency decreases, the outdoor fan speed also changes to the lower speed.

NOTE: After defrost control on the heating mode, the fan speed is kept higher regardless of the compressor frequency.

Fan speed after defrost control: 830 rpm

4. Louver control

4-1. Horizontal louver control

Each time the button is pressed, the air direction range will change as below:

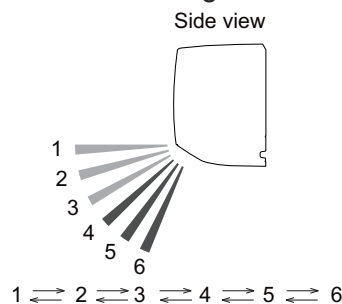

- Remote controller display is not changed.
- Vertical airflow direction is set automatically as shown, in accordance with the type of operation selected.

Operation mode	ASUH18LMAS	ASUH24LMAS
Cooling/Dry	Horizontal flow 1	
Heating	Downward flow 6	Downward flow 5

- During AUTO operation, for the first a few minutes after beginning operation, airflow will be horizontal 1; the air direction cannot be adjusted during this period. The airflow direction setting will temporarily become 1 when the temperature of the airflow is low at the start of the Heating mode.
- After beginning of AUTO/HEAT mode operated and automatic defrosting operation, the airflow will be horizontal 1. However, the airflow direction cannot be adjusted at beginning AUTO operation mode.

4-2. Vertical louver control

Each time the button is pressed, the airflow direction range will change as below:

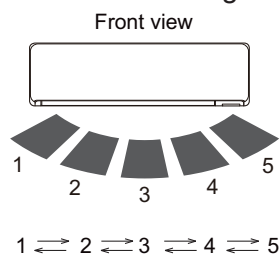

Remote controller display is not changed.

4-3. Swing operation

- To select up/down airflow swing operation
When the swing signal is received, the horizontal louver starts to swing.
 - Swinging range
 - Cooling mode/dry mode/fan mode (1 to 3): 1 ↔ 4
 - Heating mode/fan mode (4 to 6): 3 ↔ 6
 - When the indoor fan is S-LOW or stop mode, the swing operation is interrupted and it stops at either upper end or bottom end.

- To select left/right airflow swing operation
When the swing signal is received, the vertical louver starts to swing.
 - Swinging range
 - All mode: 1 ↔ 5
 - When the indoor fan is S-LOW or stop mode, the swing operation is interrupted and it stops at either left end or right end.

- To select up/down and left/right airflow swing operation
When the swing signal is received, both of the vertical and the horizontal louvers start to swing.

5. Timer operation control

5-1. Wireless remote control

On/Off timer	Program timer	Sleep timer	Weekly timer
○	○	○	—

■ On/Off timer

- Off timer: When the clock reaches the set timer, the air conditioner will be turned off.

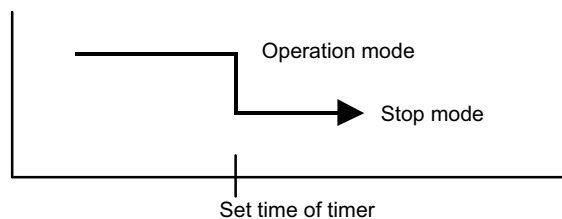

- On timer: When the clock reaches the set timer, the air conditioner will be turned on.

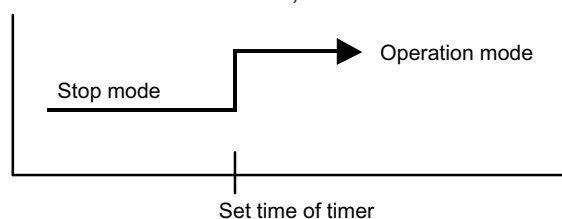

■ Program timer

- The program timer allows the off timer and the on timer to be used in combination one time.

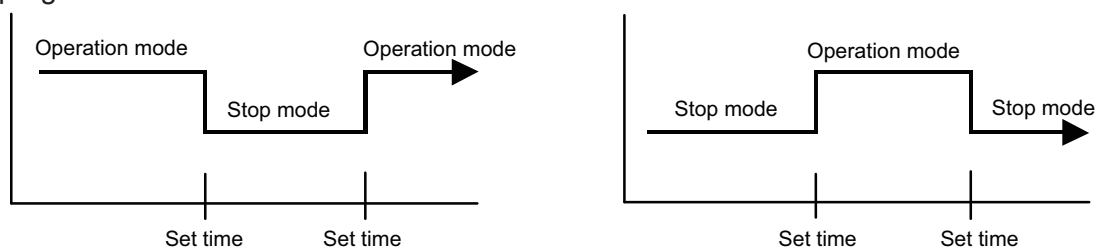

- Operation will start from the timer setting (either off timer and on timer) whichever is closest to the clock current timer setting. The order of operations is indicated by the allow in the remote controller screen.
- Sleep timer operation cannot be combined with on timer operation.

■ Sleep timer

If the sleep timer is set, the room temperature is monitored and the operation is stopped automatically. If the operation mode or the set temperature is change after the sleep timer is set, the operation is continued according to the changed setting of the sleep timer from that time on.

- In the cooling operation mode

When the sleep timer is set, the setting temperature is increased 1.8°F (1°C). It increases the setting temperature another 1.8°F (1°C) after 1 hour. After that, the setting temperature is not changed and the operation is stopped at the setting time.

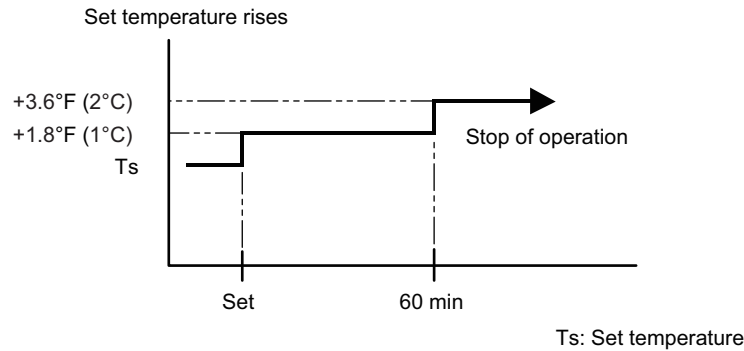

- In the heating operation mode

When the sleep timer is set, the setting temperature is decreased 1.8°F (1°C). It decreases the setting temperature another 1.8°F (1°C) every 30 minutes. Upon lowering 7.2°F (4°C), the setting temperature is not changed and the operation is stopped at the setting time.

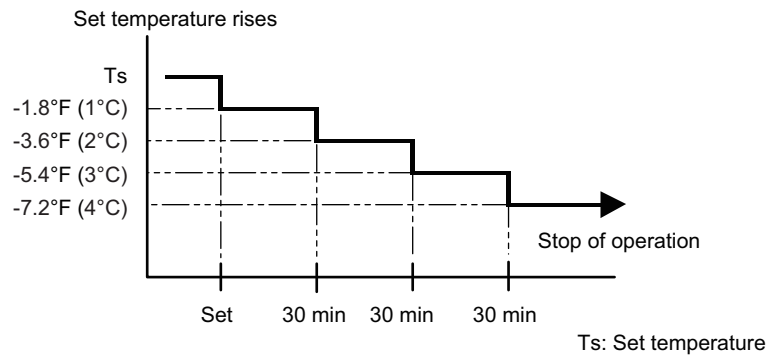

5-2. Wired remote control

On/Off timer	Program timer	Sleep timer	Weekly timer	Temperature Setback Timer
○	○	○	○	○

■ On/Off timer

- Off timer: When the clock reaches the set timer, the air conditioner will be turned off.

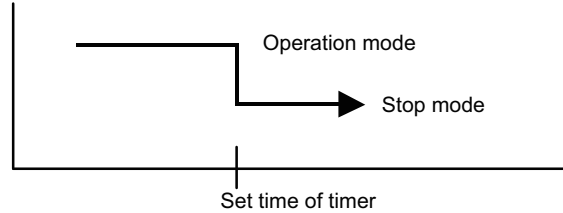

- On timer: When the clock reaches the set timer, the air conditioner will be turned on.

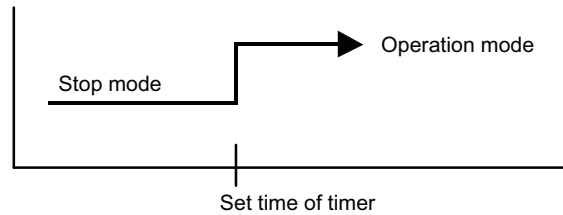

■ Program timer

- The program timer allows the off timer and the on timer to be used in combination one time.

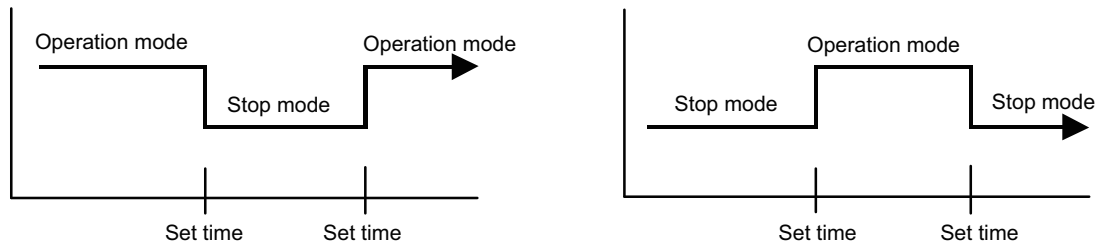

- Operation will start from the timer setting (either off timer and on timer) whichever is closest to the clock current timer setting. The order of operations is indicated by the allow in the remote controller screen.
- Sleep timer operation cannot be combined with on timer operation.

■ Sleep timer

If the sleep timer is set, the room temperature is monitored and the operation is stopped automatically. If the operation mode or the set temperature is change after the sleep timer is set, the operation is continued according to the changed setting of the sleep timer from that time on.

- In the cooling operation mode

When the sleep timer is set, the setting temperature is increased 1.8°F (1°C). It increases the setting temperature another 1.8°F (1°C) after 1 hour. After that, the setting temperature is not changed and the operation is stopped at the setting time.

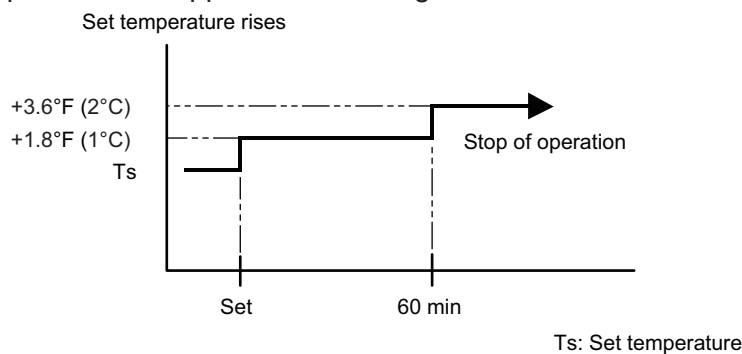

- In the heating operation mode

When the sleep timer is set, the setting temperature is decreased 1.8°F (1°C). It decreases the setting temperature another 1.8°F (1°C) every 30 minutes. Upon lowering 7.2°F (4°C), the setting temperature is not changed and the operation is stopped at the setting time.

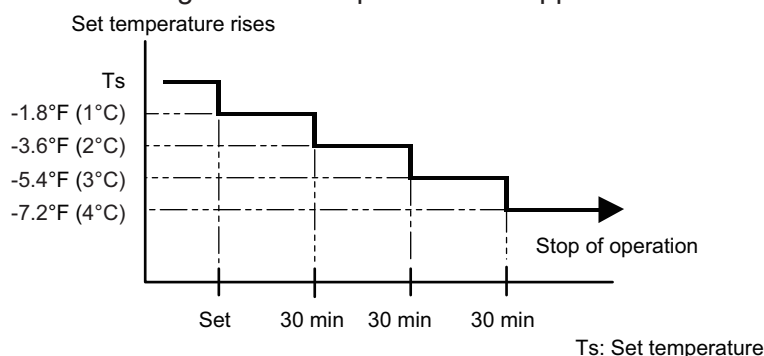

■ Weekly timer

On and off timer can be combined, and up to 4 reservations per day and 28 reservations per week. Before setting the program, set the week and time of the air conditioner at first. If the week and time are not set, the weekly timer will not operate correctly at the setting time.

■ Temperature Setback Timer

- The temperature setback timer only changes the set temperature for 7 days, it cannot be used to start or stop air conditioner operation.
- The temperature setback timer can be set to operate up to two times per day but only one temperature setting can be used.
- During COOLING/DRY mode, the air conditioner will operate at a minimum of 64°F (18°C) even if the SET BACK temperature is set to 63°F (17°C) or lower.

Case of Temperature Setback Timer on the Cooling operation. (Setting temperature :72°F [22°C], SET BACK temperature :78°F [26°C])

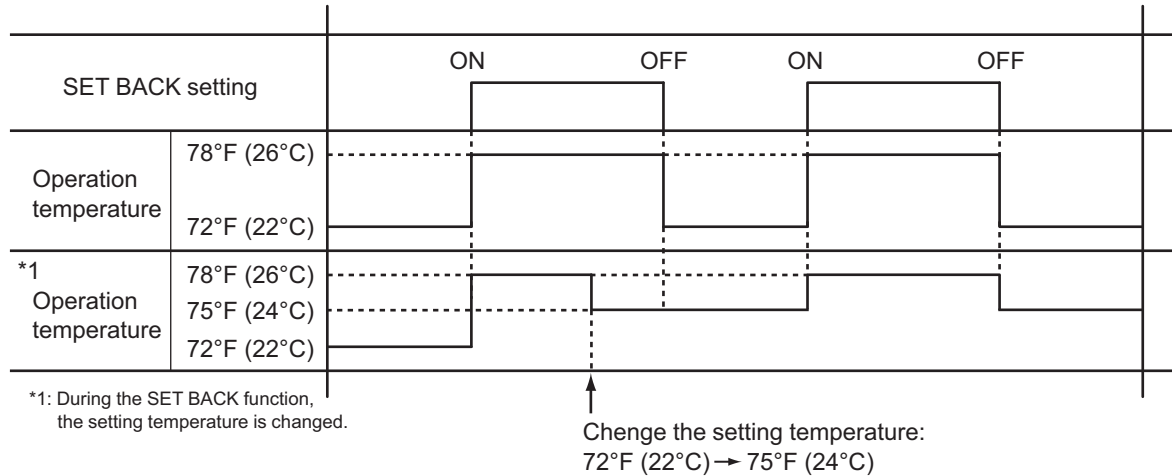

6. Defrost operation control

Tn: Outdoor unit heat exchanger temperature

Ta: Outdoor temperature

Tn10: Temperature at 10 minutes after compressor start

Tnb: Temperature before 5 minutes

• Triggering condition

The defrost operation starts when outdoor unit heat exchanger temperature sensor detects the temperature lower than the values shown below.

– 1st time defrosting after starting operation

Compressor integrating operation time	Less than 17 min.	17 to 57 min.	More than 57 min.
Condition	Does not operate	$T_n \leq 15.8^\circ\text{F} (-9^\circ\text{C})$ and $T_n - T_a \geq 9.0^\circ\text{F} (5^\circ\text{C})$	$T_n \leq 23.0^\circ\text{F} (-5^\circ\text{C})$

– 2nd time and after

Compressor integrating operation time	Less than 35 min.	More than 35 min.	
Condition	Does not operate	$T_n - T_{n10} < -9.0^\circ\text{F} (-5^\circ\text{C})$ ($T_n \leq 14.0^\circ\text{F} [-10^\circ\text{C}]$) $T_n - T_{nb} < -3.6^\circ\text{F} (-2^\circ\text{C})$ ($T_n \leq 14.0^\circ\text{F} [-10^\circ\text{C}]$) $T_n \leq -13.0^\circ\text{F} (-25^\circ\text{C})$ ($T_a \geq -4.0^\circ\text{F} [-20^\circ\text{C}]$) $T_n \leq 19.4^\circ\text{F} (-7^\circ\text{C})$ or $T_n \leq -13.0^\circ\text{F} (-25^\circ\text{C})$ ($T_a < -4.0^\circ\text{F} [-20^\circ\text{C}]$)	

– Integrating defrost (Constant monitoring)

Compressor integrating operation time	More than 240 min. (For long continuous operation)	More than 215 min. (For long continuous operation)	Less than 10 min.* (For intermittent operation)
Condition	$T_n \leq 26.6^\circ\text{F} (-3^\circ\text{C})$	$T_n \leq 23.0^\circ\text{F} (-5^\circ\text{C})$	Count of the compressor off: 40 times

*: If the compressor continuous operation time is less than 10 minutes, the number of the compressor off is counted. If any defrost operated, the compressor off count is cleared.

• Release condition

The defrost operation is released when either one of the conditions below is satisfied.

Outdoor unit heat exchanger temperature (after 1 minute or later since compressor start)	53.6 °F (12 °C) or more
Compressor operation time	15 minutes

6-1. Defrost operation in heating operation stopped

If the outdoor unit is frosted when stopping the heating operation, it stops after performing the automatic defrosting operation.

In this time, if the indoor unit operation lamp flashes slowly (6 sec on/2 sec off), the outdoor unit allow the heat exchanger to defrost, and then stop.

• Triggering condition

When all of the following conditions are satisfied in heating operation

- Compressor operation integrating time: 30 minutes or more
- Compressor continuous operation time: 10 minutes or more
- Outdoor unit heat exchanger temperature: 24.8°F (-4°C) or less

• Release condition

The defrost operation is released when either one of the conditions below is satisfied.

Outdoor unit heat exchanger temperature (after 1 minute or later since compressor start)	53.6 °F (12 °C) or more
Compressor operation time	15 minutes

7. Various control

7-1. Auto restart

When the power was interrupted by a power failure etc. during operation, the operation contents at that time are memorized and when the power is recovered, operation is automatically started with the memorized operation contents.

Operation contents memorized when the power is interrupted
Operation mode
Setting temperature
Fan mode setting
Timer mode and set time (set by wireless remote controller)
Airflow direction setting
Swing
ECONOMY operation
MIN. HEAT operation
Remote control setting
WLAN indicator lamp setting

7-2. MANUAL AUTO operation

When the wireless remote controller is lost or battery power dissipated, this function will work without the remote controller.

When MANUAL AUTO button is pressed more than 3 seconds and less than 10 seconds, MANUAL AUTO operation starts as shown in the table below. To stop operation, press the MANUAL AUTO button for 3 seconds.

	Auto changeover
Operation mode	AUTO
Fan mode	AUTO
Timer mode	Continuous (no timer setting available)
Setting temperature	75.2°F (24°C)
Horizontal louver setting	Standard
Vertical louver setting	According to memory position
SWING	Off
ECONOMY	Off
Human sensor	Off

7-3. Forced cooling operation

The outdoor unit may not operate depending on the room temperature.

When FORCED COOLING OPERATION button is pressed more than 10 seconds, forced cooling operation starts as shown in the table below.

Operation mode	Auto changeover
Fan mode	AUTO
Timer mode	Continuous (no timer setting available)
Setting temperature	75.2°F (24°C)
Horizontal louver setting	Standard
Vertical louver setting	According to memory position
SWING	Off
ECONOMY	Off
Human sensor	Off

- During the forced cooling operation, it operates regardless of room temperature sensor.
- The operation indicator lamp and the timer indicator lamp blink simultaneously during the forced cooling operation.
They blink for 1 second ON and 1 second OFF on both the operation indicator lamp and the timer indicator lamp (same as test operation).

By performing one of the following action, test operation will be canceled:

- Pressing the remote controller START/STOP button
- Pressing FORCED COOLING OPERATION button for 3 seconds
- 60 minutes passed after starting forced cooling operation

NOTE: When HEAT operation is selected on the remote controller during forced cooling operation, heating test run will begin in about 3 minutes.

7-4. MIN. HEAT operation

MIN. HEAT operation performs as below setting when pressing MIN. HEAT button.

Operation mode	Heating
Setting temperature	50°F (10°C)
Fan mode	AUTO
LED display	Economy
Defrost operation	Operate as normal

7-5. ECONOMY operation

The ECONOMY operation starts by pressing ECONOMY button on the remote controller.

The ECONOMY operation is almost the same operation as below settings.

Mode	Cooling/Dry	Heating
Target temperature	Setting temperature +2°F (1°C)	Setting temperature -2°F (1°C)

7-6. POWERFUL operation

The POWERFUL operation starts by pressing POWERFUL button on the remote controller. The indoor unit and outdoor unit operate at maximum power as shown in the table below.

		ASUH18LMAS	ASUH24LMAS
Compressor frequency		Maximum	
Fan mode		POWERFUL	
Horizontal louver setting	Cooling	3	
	Dry		
	Heating	6	5

Release condition:

- Cooling/Dry
Room temperature \leq Setting temperature -1°F (-0.5°C) or Operation time has passed 20 minutes.
- Heating
Room temperature \geq Setting temperature $+1^{\circ}\text{F}$ ($+0.5^{\circ}\text{C}$) or Operation time has passed 20 minutes.

7-7. Fresh air control

The fan motor for Fresh Air is operated in synchronization with the indoor fan operation as below.

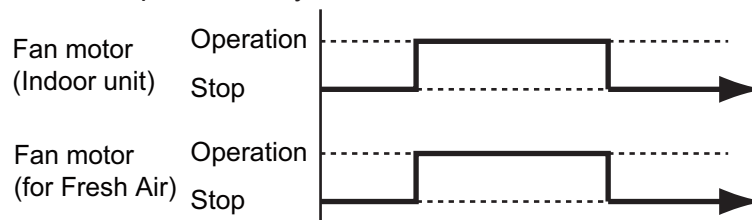

7-8. Compressor preheating

By preheating the compressor, warm airflow is quickly discharged when the operation is started.

- **Triggering condition 1**
 - Outdoor temperature $\leq 68^{\circ}\text{F}$ (20°C)
When outdoor temperature reaches 78.8°F (26°C), compressor preheating stops.
 - 30 minutes after compressor stopped
- **Triggering condition 2**

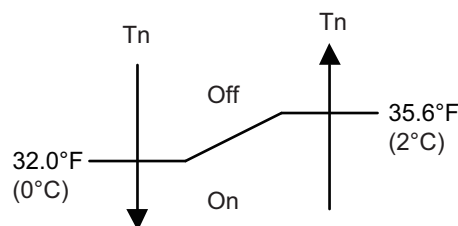

Tn: Outdoor unit heat exchanger temp.

7-9. External electrical heater control

The external electrical heater is operated as below.

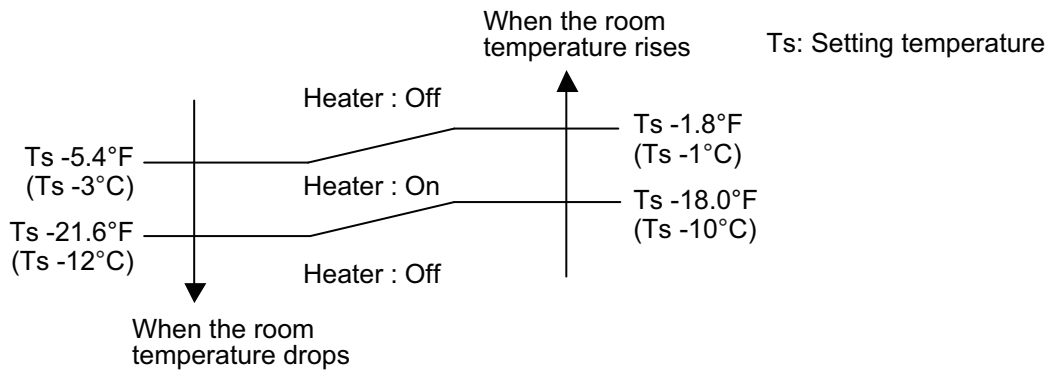

NOTES:

- When the compressor stop, external electric heater is off.
- It operates only in heating mode and when the indoor fan operates. (However, S-LOW is excluded.)

7-10. Electronic expansion valve control

The most proper opening of the electronic expansion valve is calculated and controlled under the present operating condition based on the table below.

Operation mode	Pulse range
Cooling/dry mode	Between 47 and 480 pulses
Heating mode	Between 39 and 480 pulses

NOTE: At the time of supplying the power to the outdoor unit, the initialization of the electronic expansion valve is operated (528 pulses are input to the closing direction).

7-11. Prevention to restart for 3 minutes (3 minutes st)

When the compressor fails to start for the number of times below, it does not enter operation status for 3 minutes.

Retry number	30
Retry set number	3

When the compressor fails to start in the retry set number above, the compressor is stopped.

7-12. 4-way valve control

- If heating mode is selected at the compressor start, 4-way valve is energized for heating.
- When the air conditioner is switched between cooling and heating mode, compressor is stopped, and the 4-way valve is switched when the 3 minutes passes and the compressor is started.

7-13. Peak cut operation

The current value is limited to reduce the power consumption by external input.

Peak cut level	Level 1	Level 2	Level 3	Level 4
Peak cut for rated capacity	Forced thermostat off	50%	75%	100%

NOTES:

- During defrost operation, peak cut operation becomes invalid.
- Even during the peak cut operation, the operations of current overload, economy, and low noise are effective and the outdoor unit operates by lowest current of them.

7-14. Unit status monitoring and the detected value indication

The wired remote controller can monitor the indoor and outdoor units' status and display the detected result as a relevant ID.

For details of the display method, refer to the Chapter of "Display Sensor Values" in the *Installation Manual of Wired Remote Controller (Touch Panel)*.

The status can be monitored and displayed on the wired remote controller by assigning an arbitrary ID. For available ID list, refer to the table below.

NOTE: Operating time for each part cannot be reset when the part is replaced. Take notes of the operating time before replacing to count the operating time of the replaced part.

Available Sensor ID			
Sensor ID	Item	Unit	Remarks
00: Indoor unit			
00	000	Suction temp.	01: °F or °C
00	001	Room temp.	01: °F or °C When the wired remote controller thermistor is enabled, temperature of the wired remote controller thermistor is displayed.
00	002	Wired remote controller detected temp.	01: °F or °C
00	006	Heat exchanger middle temp.	01: °F or °C
00	020	Fan rotation number	03: rpm
00	080	Indoor unit total energized hours	11: h
00	081	Total filtering hours	11: h
00	082	Indoor unit fan total operation hours	11: h
00	095	Presence or absence detected by human sensor	00: — 0: Absence, 1: Presence —: Human sensor error or No human sensor
00	140	Operation or Stop (External input)	00: — 0: Off, 1: On —: When the function setting 46 is not set NOTE: Available only for external input port of the indoor unit
00	142	Forced stop (External input)	00: — 0: Off, 1: On —: When the function setting 46 is not set NOTE: Available only for external input port of the indoor unit

Available Sensor ID				
Sensor ID		Item	Unit	Remarks
00	143	Operation or Stop 2 (External input)	00: —	0: Off, 1: On —: When the function setting 46 is not set NOTE: Available only for external input port of the indoor unit
00	155	Operation or Stop On/Off (External output)	00: —	0: Off, 1: On NOTE: The value is output even if the function setting or rotary switch is not set.
00	156	Error On/Off (External output)	00: —	0: Off, 1: On NOTE: The value is output even if the function setting or rotary switch is not set.
00	157	Indoor unit fan interlocking On/Off (External output)	00: —	0: Off, 1: On NOTE: The value is output even if the function setting or rotary switch is not set.
00	158	Cooling thermostat On/Off (External output)	00: —	0: Off, 1: On NOTE: The value is output even if the function setting or rotary switch is not set.
00	159	Requested cooling strength On/Off (External output)	00: —	0: Off, 1: On NOTE: The value is output even if the function setting or rotary switch is not set.
00	160	External heater On/Off (External output)	00: —	0: Off, 1: On NOTE: The value is output even if the function setting or rotary switch is not set.
00	161	Heating operation status (External output)	00: —	0: Off, 1: On NOTE: The value is output even if the function setting or rotary switch is not set.
00	162	External output command by remote controller (External output)	00: —	0: Off, 1: On NOTE: The value is output even if the function setting or rotary switch is not set.
01: Outdoor unit				
01	000	Outdoor temp.	01: °F or °C	
01	001	Discharge temp.	01: °F or °C	
01	002	Suction temp.	01: °F or °C	
01	003	Heat exchanger middle temp.	01: °F or °C	
01	004	Heat exchanger outlet temp.	01: °F or °C	
01	050	Fan 1 rotation number	03: rpm	
01	055	Compressor rotation number	04: rps	
01	060	Expansion valve (Upstream during heating)	05: pls	
01	080	4-way valve output status	07: Cooling/ Heating	0: Cooling, 1: Heating
01	100	Operating current	09: A	
01	110	Outdoor unit total power-on hours	11: h	
01	111	Compressor total heating operation hours	11: h	
01	112	Compressor total cooling operation hours	11: h	
01	113	Compressor total operation hours	11: h	

Available Sensor ID				
Sensor ID		Item	Unit	Remarks
01	114	Outdoor unit fan 1 total operation hours	11: h	

8. Various protections

8-1. Discharge gas temperature over-rise prevention control

The discharge gas temperature sensor (discharge thermistor: outdoor unit side) detects the discharge gas temperature.

- When the discharge temperature becomes higher than the trigger condition, the compressor frequency is decreased as the table below, and it continues to decrease until the discharge temperature becomes lower than the trigger condition.
- When the discharge temperature becomes lower than the release condition, control of compressor frequency is released.
- When the discharge temperature becomes higher than the compressor protection temperature, the compressor is stopped and the indoor unit indicator lamp starts blinking.

Trigger condition	219.2°F (104°C)
Compressor frequency	-14 rps/120 seconds
Release condition	213.8°F (101°C)
Compressor protection temperature	230.0°F (110°C)

8-2. Anti-freezing control (cooling and dry mode)

The rotation number of compressor is decrease in cooling and dry mode when the indoor unit heat exchanger temperature sensor detects the temperature lower than the trigger condition.

When the indoor unit heat exchanger temperature reaches release condition, the anti-freezing control is stopped.

Trigger condition		39.2°F (4°C)
Release condition	Outdoor temp. \geq 50°F (10°C)*1	44.6°F (7°C)
	Outdoor temp. \geq 53.6°F (12°C)*2	
	Outdoor temp. $<$ 50°F (10°C)*1	55.4°F (13°C)
	Outdoor temp. $<$ 53.6°F (12°C)*2	

*1: During the outdoor temperature dropping

*2: During the outdoor temperature rising

8-3. Current release control

The rotation number of compressor is controlled so that the outdoor unit input current does not exceeds current limit value set according to the outdoor temperature.

The rotation number of compressor returns according to the operation mode, when the current becomes lower than the release value.

■ AOUH18LMAS1

Operation mode	Outdoor temp. (Ta)	Trigger condition	Release condition
Cooling	$125.6\text{ °F (52 °C)} \leq Ta$	8.0 A	7.5 A
	$122.0\text{ °F (50 °C)} \leq Ta < 125.6\text{ °F (52 °C)}$	10.0 A	9.5 A
	$Ta < 122.0\text{ °F (50 °C)}$	12.5 A	12.0 A
Heating	$60.8\text{ °F (16 °C)} \leq Ta$	10.0 A	9.5 A
	$53.6\text{ °F (12 °C)} \leq Ta < 60.8\text{ °F (16 °C)}$	11.5 A	11.0 A
	$Ta < 53.6\text{ °F (12 °C)}$	13.0 A	12.5 A

■ AOUH24LMAS1

Operation mode	Outdoor temp. (Ta)	Trigger condition	Release condition
Cooling	$125.6\text{ °F (52 °C)} \leq Ta$	8.0 A	7.5 A
	$122.0\text{ °F (50 °C)} \leq Ta < 125.6\text{ °F (52 °C)}$	10.0 A	9.5 A
	$114.8\text{ °F (46 °C)} \leq Ta < 122.0\text{ °F (50 °C)}$	13.0 A	12.5 A
	$107.6\text{ °F (42 °C)} \leq Ta < 114.8\text{ °F (46 °C)}$	14.0 A	13.5 A
	$Ta < 107.6\text{ °F (42 °C)}$	14.5 A	14.0 A
Heating	$68.0\text{ °F (20 °C)} \leq Ta$	11.0 A	10.5 A
	$60.8\text{ °F (16 °C)} \leq Ta < 68.0\text{ °F (20 °C)}$	13.0 A	12.5 A
	$Ta < 60.8\text{ °F (16 °C)}$	15.0 A	14.5 A

8-4. Compressor temperature protection

When the compressor temperature sensor detects higher than the trigger condition below, the compressor is stopped. When the compressor temperature sensor detects the release condition, the protection is released.

Trigger condition	226.4°F (108°C)
Release condition	176.0°F (80°C) (3 minutes after compressor stop)

8-5. High pressure protection

Trigger condition	Pressure switch: Off (Open: Higher than 4.2 MPa) Compressor stop
Release condition	Pressure switch: On (Close: Lower than 3.2 MPa) (3 minutes after compressor stop) Compressor restart

8-6. Low outdoor temperature protection

When the outdoor temperature sensor detects lower than the trigger condition below, the compressor is stopped.

Operation mode	Cooling/Dry
Trigger condition	-4°F (-20°C)
Release condition	5°F (-15°C)

8-7. High temperature and high pressure release control

The compressor is controlled as follows.

• Cooling mode

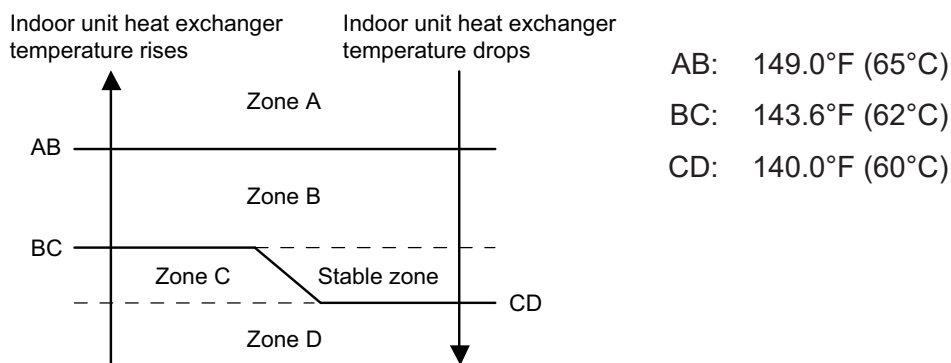

Zone	Operation	
Zone A	Compressor is stopped.	
Zone B	The compressor frequency is decreased.	-7 rps/120 sec.
Zone C	The protection is released and the operation is returned to normal mode.	
Zone D		

• Heating mode

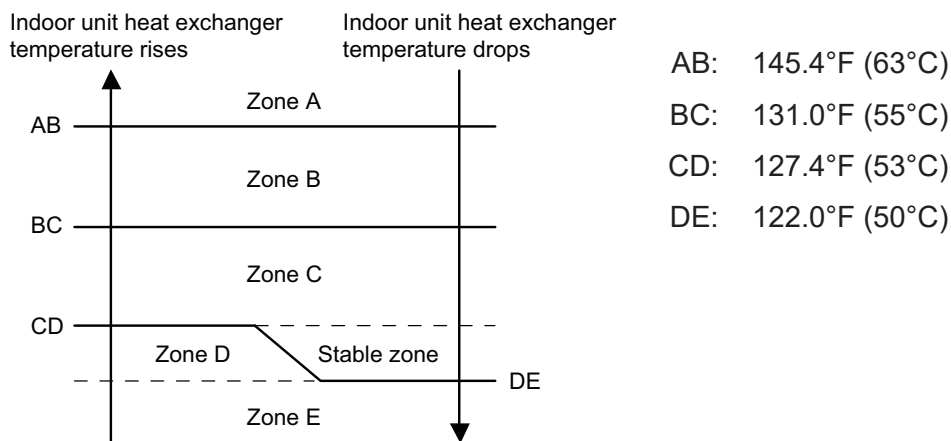

Zone	Operation	
Zone A	Compressor is stopped.	
Zone B	The compressor frequency is decreased.	-15 rps/120 sec.
Zone C		-2 rps/120 sec.
Zone D	The protection is released and the operation is returned to normal mode.	
Zone E		

5. FILED WORKING

CONTENTS

5. FILED WORKING

1. Function settings (Indoor unit)	05-1
1-1. Function settings by using remote controller	05-1
1-2. Custom code setting for wireless remote controller	05-11
1-3. Switching the temperature unit of remote controller.....	05-12
2. Function settings (Outdoor unit)	05-13
2-1. Control PCB and switch buttons location.....	05-13
2-2. Local setting procedure	05-15
3. External input and output (Indoor unit)	05-17
3-1. External input.....	05-18
3-2. External output	05-20
3-3. Combination of external input and output	05-22
3-4. Details of function	05-24
4. External input and output (Outdoor unit)	05-47
4-1. External input.....	05-47
4-2. External output	05-49

1. Function settings (Indoor unit)

To adjust the functions of this product according to the installation environment, various types of function settings are available.

NOTE: Incorrect settings can cause a product malfunction.

1-1. Function settings by using remote controller

Some function settings can be changed on the remote controller. After confirming the setting procedure and the content of each function setting, select appropriate functions for your installation environment.

■ Setting procedure by using wireless remote controller

The function number and the associated setting value are displayed on the LCD of the remote controller. Follow the instructions written in the local setup procedure supplied with the remote controller, and select appropriate setting according to the installation environment.

Before connecting the power supply of the indoor unit, reconfirm following items:

- Cover for the electrical enclosure on the outdoor unit is in place.
- There is no wiring mistake.
- Piping air tightness test and vacuuming have been performed firmly.
- All the necessary wiring work for outdoor unit has been finished.

After reconfirming the items listed above, connect the power supply of the indoor unit.

NOTES:

- Settings will not be changed if invalid numbers or setting values are selected.
- When optional wired remote controller is used, refer to the installation manual enclosed with the remote controller.

Entering function setting mode:

While pressing the POWERFUL button and TEMP. (^) button simultaneously, press the RESET button to enter the function setting mode.

Selecting the function number and setting value:

1. Press the MIN. HEAT button. TEMP. (^) (v) buttons to select the function number. Press the MIN. HEAT button to switch between the left and right digits.
2. Press the POWERFUL button to proceed to value setting. To return the function number selection, press the POWERFUL button again.
3. Press the TEMP. (^) (v) buttons to select the setting value. To switch between the left and right digits, press the MIN. HEAT button.
4. Press the MODE button once. Confirm that you hear the beep sound.
5. Press the START/STOP button to fix the function setting. Confirm that you hear the beep sound.
6. Press the RESET button to end the function setting mode.
7. After completing the function setting, be sure to disconnect the power supply and then reconnect it.

Function number
Setting value

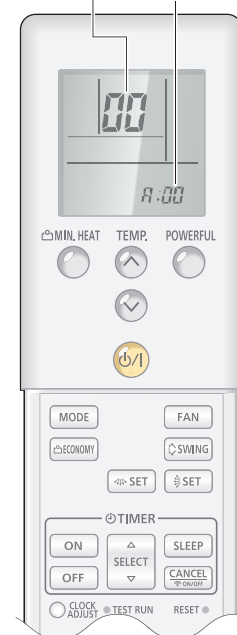

⚠ CAUTION

After disconnecting the power supply, wait 30 seconds or more before reconnecting it. The function setting will not become active unless the power supply is disconnected and then reconnected.

NOTES:

- The air conditioner custom code is set to \overline{H} prior to shipment.
- If you do not know the air conditioner custom code setting, try each of the custom codes ($\overline{H} \rightarrow \overline{b}$
 $\rightarrow \overline{c} \rightarrow \overline{d}$) until you find the code that operates the air conditioner.

■ Contents of function setting

Each function setting listed in this section is adjustable in accordance with the installation environment.

NOTE: Setting will not be changed if invalid numbers or setting values are selected.

● Function setting list

	Function no.	Functions
1)	11	Filter sign
2)	30/31	Room temperature control for indoor unit sensor
3)	35/36	Room temperature control for wired remote controller sensor
4)	40	Auto restart
5)	42	Room temperature sensor switching
6)	44	Remote controller custom code
7)	46	External input control
8)	48	Room temperature sensor switching (Aux.)
9)	49	Indoor unit fan control for energy saving for cooling
10)	60	Switching functions for external output terminal
11)	61	Control switching of external heaters
12)	62	Operating temperature switching of external heaters
13)	66	Outdoor temperature zone boundary temperature A
14)	67	Outdoor temperature zone boundary temperature B
15)	71	Standby time for auxiliary equipment operation
16)	72	Heat pump backup setting
17)	73	Emergency heat for external output terminal
18)	94	Fixed operation mode switching
19)	95	Heat insulation condition (building insulation)
20)	96	Special cooling operation

1) Filter sign

Select appropriate intervals for displaying the filter sign on the indoor unit according to the estimated amount of dust in the air of the room.

If the indication is not required, select "No indication" (03).

Function number	Setting value	Setting description	Factory setting
11	00	Standard (400 hours)	
	01	Long interval (1,000 hours)	
	02	Short interval (200 hours)	
	03	No indication	◆

2) Room temperature control for indoor unit sensor

NOTE: Before performing this setting, refer to Function 95.

Depending on the installed environment, correction of the room temperature sensor may be required. Select the appropriate control setting according to the installed environment.

The temperature of the room temperature sensor is corrected as follows:

Corrected temp. = Temp. of the room temp. sensor - Correction temp. value

Example of correction:

When the temperature of the room temp. sensor is 78°F and the setting value is "03" (-2°F), the corrected temp. will be 80°F (78°F - [-2°F]).

The temperature correction values show the difference from the Standard setting "00" (manufacturer's recommended value).

*When Function 95-01 (High insulation) is set, the Standard setting "00" will be the same as "No correction 0.0 °F (0.0 °C)" (01).

Function number		Setting value	Setting description	Factory setting	
30 (For cooling)	31 (For heating)	00	Standard setting*	◆	
		01	No correction 0.0 °F (0.0 °C)		
		02	-1 °F (-0.5 °C)	More cooling Less heating	
		03	-2 °F (-1.0 °C)		
		04	-3 °F (-1.5 °C)		
		05	-4 °F (-2.0 °C)		
		06	-5 °F (-2.5 °C)		
		07	-6 °F (-3.0 °C)		
		08	-7 °F (-3.5 °C)		
		09	-8 °F (-4.0 °C)		
		10	+1 °F (+0.5 °C)	Less cooling More heating	
		11	+2 °F (+1.0 °C)		
		12	+3 °F (+1.5 °C)		
		13	+4 °F (+2.0 °C)		
		14	+5 °F (+2.5 °C)		
		15	+6 °F (+3.0 °C)		
		16	+7 °F (+3.5 °C)		
17	+8 °F (+4.0 °C)				

3) Room temperature control for wired remote controller sensor

NOTE: Before performing this setting, refer to Function 95.

Depending on the installed environment, correction of the wire remote temperature sensor may be required. Select the appropriate control setting according to the installed environment.

To change this setting, set Function 42 to "Both" (01).

Ensure that the Thermo Sensor icon is displayed on the remote controller screen.

*When Function 95-01 (High insulation) is set, the Standard setting "00" will be the same as "No correction 0.0 °C" (01).

Function number		Setting value	Setting description	Factory setting	
35 (For cooling)	36 (For heating)	00	Standard setting*	◆	
		01	No correction 0.0 °F (0.0 °C)		
		02	-1 °F (-0.5 °C)	More cooling Less heating	
		03	-2 °F (-1.0 °C)		
		04	-3 °F (-1.5 °C)		
		05	-4 °F (-2.0 °C)		
		06	-5 °F (-2.5 °C)		
		07	-6 °F (-3.0 °C)		
		08	-7 °F (-3.5 °C)		
		09	-8 °F (-4.0 °C)		
		10	+1 °F (+0.5 °C)	Less cooling More heating	
		11	+2 °F (+1.0 °C)		
		12	+3 °F (+1.5 °C)		
		13	+4 °F (+2.0 °C)		
		14	+5 °F (+2.5 °C)		
		15	+6 °F (+3.0 °C)		
		16	+7 °F (+3.5 °C)		
17	+8 °F (+4.0 °C)				

4) Auto restart

Enables or disables automatic restart after a power interruption.

Function number	Setting value	Setting description	Factory setting
40	00	Enable	◆
	01	Disable	

NOTE: Auto restart is an emergency function such as for power outage etc. Do not attempt to use this function in normal operation. Be sure to operate the unit by remote controller or external device.

5) Room temperature sensor switching

(Only for wired remote controller)

When using the wired remote controller temperature sensor, change the setting to "Both" (01).

Function number	Setting value	Setting description	Factory setting
42	00	Indoor unit	◆
	01	Both	

00: Sensor on the indoor unit is active.

01: Sensors on both indoor unit and wired remote controller are active.

NOTE: Remote controller sensor must be turned on by using the remote controller.

6) Remote controller custom code

(Only for wireless remote controller)

The indoor unit custom code can be changed. Select the appropriate custom code.

Function number	Setting value	Setting description	Factory setting
44	00	A	◆
	01	B	
	02	C	
	03	D	

7) External input control

"Operation/Stop" mode or "Forced stop" mode can be selected.

Function number	Setting value	Setting description	Factory setting
46	00	Operation/Stop mode 1 (R.C. enabled)	◆
	01	(Setting prohibited)	
	02	Forced stop mode	
	03	Operation/Stop mode 2 (R.C. disabled)	

8) Room temperature sensor switching (Aux.)

To use the temperature sensor on the wired remote controller only, change the setting to "Wired remote controller" (01).

This function will only work if the function setting 42 is set at "Both" (01).

When the setting value is set to "Both" (00), more suitable control of the room temperature is possible by setting function setting 30 and 31 too.

Function number	Setting value	Setting description	Factory setting
48	00	Both	◆
	01	Wired remote controller	

9) Indoor unit fan control for energy saving for cooling

Enables or disables the power-saving function by controlling the indoor unit fan rotation when the outdoor unit is stopped during cooling operation.

Function number	Setting value	Setting description	Factory setting
49	00	Disable	
	01	Enable	
	02	Remote controller	◆

00: When the outdoor unit is stopped, the indoor unit fan operates continuously following the setting on the remote controller.

01: When the outdoor unit is stopped, the indoor unit fan operates intermittently at a very low speed.

02: Enable or disable this function by remote controller setting.

NOTES:

- As the factory setting, this setting is initially invalidated.
- Set to "00" or "01" when connecting a remote controller that cannot set the Fan control for energy saving function or connecting a network converter.
To confirm if the remote controller has this setting, refer to the operating manual of each remote controller.

10) Switching functions for external output terminal

Functions of the external output terminal can be switched. For details, refer to “External input and output”.

Function number	Setting value	Setting description	Factory setting
60	00	Operation status	◆
	01—04	Cooling thermostat On	
	05	Heating operation	
	06	Operation/Stop	
	07—08	Cooling thermostat On	
	09	Error status	
	10	Indoor unit fan operation status	
	11	External heater	
	12	Setpoint Attainment status	

11) Control switching of external heaters

Sets the control method for external heater to be used.

For details, refer to “External heater output” in [Chapter 3-4. "Details of function"](#) on page 05-24.

Function number	Setting value	Setting description	Factory setting
61	00	Auxiliary heater control 1	◆
	01	Auxiliary heater control 2	
	02	Heat pump prohibition control	
	03	Auxiliary heater control by outdoor temperature 1	
	04	Auxiliary heater control by outdoor temperature 2	
	05	Auxiliary heater control by outdoor temperature 3	
	06	Auxiliary heat pump control	
	07	Auxiliary heat pump control by outdoor temperature 1	
	08	Auxiliary heat pump control by outdoor temperature 2	
	09	Auxiliary heat pump control by outdoor temperature 3	

12) Operating temperature switching of external heaters

Sets the temperature conditions when the external heater is ON.

For details, refer to “External heater output” in [Chapter 3-4. "Details of function"](#) on page 05-24.

Function number	Setting value	Setting description		Factory setting
		Heater: On	Heater: Off	
62	00	-5.4 °F (-3 °C)	-1.8 °F (-1 °C)	◆
	01	-3.6 °F (-2 °C)	-1.8 °F (-1 °C)	
	02	-3.6 °F (-2 °C)	-1.8 °F (-1 °C)	
	03	-5.4 °F (-3 °C)	-1.8 °F (-1 °C)	
	04	-7.2 °F (-4 °C)	-1.8 °F (-1 °C)	
	05	-9.0 °F (-5 °C)	-1.8 °F (-1 °C)	

13) Outdoor temperature zone boundary temperature A

Setting required if changing of the outdoor temperature setting for heat pump prohibition zone is required when auxiliary heater control by outdoor temperature 1 and 2 are performed on the indoor unit. For details, refer to "External heater output" in [Chapter 3-4. "Details of function"](#) on page 05-24.

Function number	Setting value	Setting description	Factory setting
66	00	-4.0 °F (-20 °C)	◆
	01	-0.4 °F (-18 °C)	
	02	3.2 °F (-16 °C)	
	03	6.8 °F (-14 °C)	
	04	10.4 °F (-12 °C)	
	05	14.0 °F (-10 °C)	
	06	17.6 °F (-8 °C)	
	07	21.2 °F (-6 °C)	
	08	24.8 °F (-4 °C)	

14) Outdoor temperature zone boundary temperature B

Setting required if changing of the outdoor temperature setting for heat pump only zone is required when auxiliary heater control by outdoor temperature 1 is performed on the indoor unit. For details, refer to "External heater output" in [Chapter 3-4. "Details of function"](#) on page 05-24.

Function number	Setting value	Setting description	Factory setting
67	00	42.8 °F (6 °C)	◆
	01	14.0 °F (-10 °C)	
	02	17.6 °F (-8 °C)	
	03	21.2 °F (-6 °C)	
	04	24.8 °F (-4 °C)	
	05	28.4 °F (-2 °C)	
	06	32.0 °F (0 °C)	
	07	35.6 °F (2 °C)	
	08	39.2 °F (4 °C)	
	09	42.8 °F (6 °C)	
	10	46.4 °F (8 °C)	
	11	50.0 °F (10 °C)	
	12	53.6 °F (12 °C)	
	13	57.2 °F (14 °C)	
	14	60.8 °F (16 °C)	
	15	64.4 °F (18 °C)	

15) Standby time for auxiliary equipment operation

Sets the standby time until the auxiliary equipment operation starts during primary equipment operation.

For details, refer to [Chapter 3-4. "Details of function"](#) on page 05-24.

Function number	Setting value	Setting description	Factory setting
71	00	Disable	◆
	01	1 minute	
	02	2 minutes	
	•	•	
	•	•	
	•	•	
	98	98 minutes	
	99	99 minutes	

16) Heat pump backup setting

Enables or disables the heat pump backup instruction from the outdoor unit.

This function will be usable provided that the corresponding outdoor unit is connected.

Function number	Setting value	Setting description	Factory setting
72	00	Disable	◆
	01	Enable	

17) Emergency heat for external output terminal

Enables or disables emergency heat input.

Function number	Setting value	Setting description	Factory setting
73	00	Disable	◆
	01	Enable	

NOTE: When this function is used, IR Receiver Unit is necessary.

18) Fixed operation mode switching

Sets the operation mode to heat pump, heating only, or cooling only.

Function number	Setting value	Setting description	Factory setting
94	00	Heat pump	◆
	01	Heating only	
	02	Cooling only	

NOTE: Do not use "Heating only" mode (01) of Function 94 and "Enabled" (01) of Function 96 simultaneously.

19) Heat insulation condition (building insulation)

Heat insulation conditions differ according to the installed environment.

"Standard insulation" (00) allows system to rapidly respond to the cooling or heating load changes.

"High insulation" (01) is when the heat insulation structure of the building is high and does not require system to rapidly respond to cooling or heating load changes.

When "High insulation" (01) is selected:

- Overheating (overcooling) is prevented at the start-up.
- All room-temperature control settings (Function 30, 31, 35, and 36) will reset to "No correction 0.0 °F (0.0 °C)".

Function number	Setting value	Setting description	Factory setting
95	00	Standard insulation	◆
	01	High insulation	

NOTE: When changing Function 95, perform this setting before other room-temperature control settings (Function 30, 31, 35, and 36). If Function 95 is not set first, room-temperature control settings (Function 30, 31, 35, and 36) will be reset and you must re-do them again.

20) Special cooling operation

Stabilizes the cooling operation when the outdoor temperature is low.

- Operation mode: Fixed at COOL
- Airflow: Fixed at HIGH
- Set temperature: 76°F (24°C) to 88°F (30°C)

Function number	Setting value	Setting description	Factory setting
96	00	Disable	◆
	01	Enable	

NOTES:

- Do not enable this function when the Function 94 setting is “Heating only” (01).
- Connect the optional wired remote controller to change the setting value to “Enable” (01).
- Do not use the wireless remote controller after changing the setting value to “Enable” (01).
- If the wired remote controller becomes noncommunicable after setting “Enable” (01), the cooling operation starts automatically.
- If dew condenses on the indoor unit surface after setting “Enable” (01), set the setting value back to “Disable” (00).

1-2. Custom code setting for wireless remote controller

To interconnect the air conditioner and the wireless remote controller, assignment of the custom code for the wireless remote controller is required.

NOTE: Air conditioner cannot receive a signal if the air conditioner has not been set for the custom code.

When 2 or more air conditioners are installed in a room, and the remote controller is operating an air conditioner other than the one you wish to set, change the custom code of the remote controller to operate only the air conditioner you wish to set. (4 selections possible.)

Confirm the setting of the remote controller custom code and the function setting. If these do not match, the remote controller cannot be used to operate for the air conditioner.

1. Press the START/STOP button until only the clock is displayed on the remote controller display.
2. Press the MODE button for at least 5 seconds to display the current custom code. (Initially set to H .)
3. Press the TEMP. (\wedge) (\vee) buttons to change the custom code between $\text{H} \rightarrow \text{b} \rightarrow \text{c} \rightarrow \text{d}$. Match the code on the display to the air conditioner custom code. (Initially set to H .)
4. Press the MODE button again to return to the clock display. The custom code will be changed.



NOTES:

- If no button is pressed within 30 seconds after the custom code is displayed, the system returns to the original clock indicator. In this case, start again from step 1.
- The air conditioner custom code is set to H prior to shipment. To change the custom code, contact your retailer.
- If you do not know the assigned code for the air conditioner, try each of the custom code ($\text{H} \rightarrow \text{b} \rightarrow \text{c} \rightarrow \text{d}$) until you find the code which operates the air conditioner.

1-3. Switching the temperature unit of remote controller

Displayed temperature unit on the remote controller LCD can be switched between °F (Fahrenheit) and °C (Celsius).

To change temperature unit, do as follows:

1. Press the TEMP. (Up) button (∧) for at least 5 seconds to display the current temperature unit. (Factory setting: °F)
2. Press the TEMP. (∧) (∨) buttons to switch the temperature unit between °F and °C.
3. With either of pressing the START/STOP button or no additional button operation for 30 seconds in step 2., the temperature unit currently selected will be set.

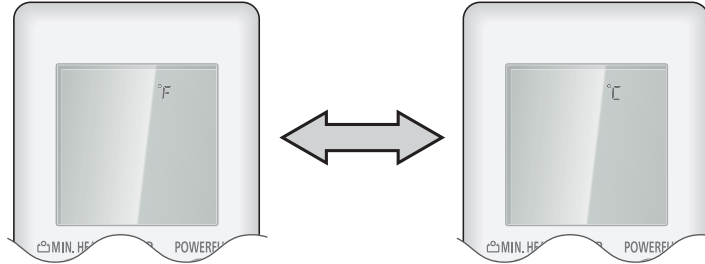

2. Function settings (Outdoor unit)

Perform appropriate function setting locally according to the installation environment.

NOTE: Incorrect settings can cause a product malfunction.

⚠ CAUTION

- Before setting up the switch buttons, discharge the static electricity from your body.
- Never touch the terminals or the patterns on the parts that are mounted on the PCB.

2-1. Control PCB and switch buttons location

Control PCB of the outdoor unit is located as shown in the following figure.

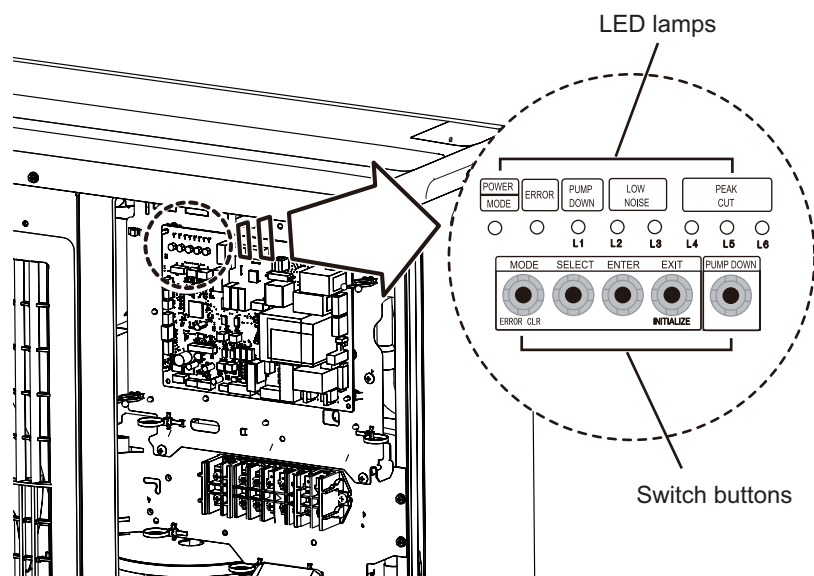

■ Switch buttons and the functions

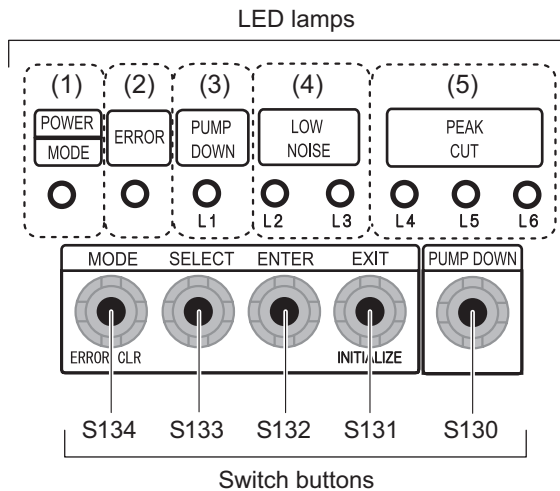

LED lamp			Function or operation method
(1)	POWER/MODE	Green	Lights on while power on. Blinks to show the local setting on the outdoor unit or the error code.
(2)	ERROR	Red	Blinks during error operation.
(3)	PUMP DOWN (L1)	Orange	Lights on during pump down operation.
(4)	LOW NOISE MODE (L2 and L3)	Orange	Lights on during "Low noise mode" when local setting is activated. (Light pattern of L2 and L3 indicates the low noise level.)
(5)	PEAK CUT MODE (L4, L5, and L6)	Orange	Lights on during "Peak cut mode" when local setting is activated. (Light pattern of L4, L5, and L6 indicates the peak cut level.)

Switch button		Function or operation method
S134	MODE	Switches between "Local setting" and "Error code display".
S133	SELECT	Switches between the individual "Local settings" and the "Error code displays".
S132	ENTER	Switches between the individual "Local settings" and the "Error code displays".
S131	EXIT	Returns to "Operation status display".
S130	PUMP DOWN	Starts the pump down operation.

FIELD WORKING

FIELD WORKING

2-2. Local setting procedure

NOTE: Before performing the function setting, be sure to stop the operation of the air conditioner.

Low noise mode

1. Press the MODE switch button (S134) for 3 seconds or more to switch to "Local setting mode".
2. After confirming the LED lamp of POWER/MODE blinks 9 times, press the ENTER switch button (S132).

POWER MODE	ERROR	PUMP DOWN (L1)	LOW NOISE (L2) (L3)		PEAK CUT (L4) (L5) (L6)		
Blinks (9 times)	○	○	○	○	○	○	○

Sign "○": Lights off

3. Press the SELECT switch button (S133), and adjust the LED lamp as shown below. Then the LED lamp indicates the current setting.

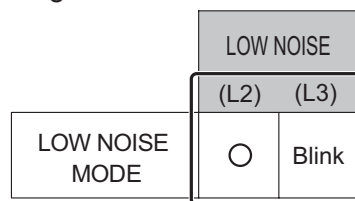

4. Press the ENTER switch button (S132).

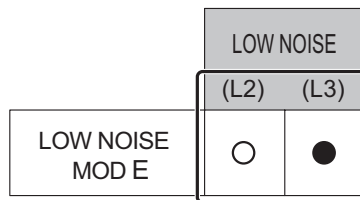

Sign "●": Lights on

5. Press the SELECT switch button (S133), and adjust the LED lamps as shown below.

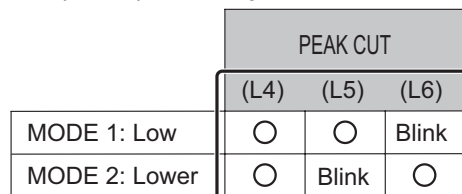

6. Press the ENTER switch button (S132) and fix it.

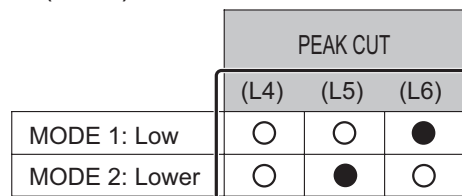

7. To return to "Operating status display (Normal operation)", press the EXIT switch button (S131).

In case of missing how many times you pressed the SELECT and ENTER switch buttons:

1. To return to "Operation status display (Normal operation)", press the EXIT switch button once.
2. Restart from the beginning of setting procedure.

■ Peak cut mode

1. Press the MODE switch button (S134) for 3 seconds or more to switch to “Local setting mode”.
2. After confirming the LED lamp of POWER/MODE blinks 9 times, press the ENTER switch button (S132).

POWER MODE	ERROR	PUMP DOWN (L1)	LOW NOISE		PEAK CUT		
			(L2)	(L3)	(L4)	(L5)	(L6)
Blinks (9 times)	○	○	○	○	○	○	○

Sign “○”: Lights off

3. Press the SELECT switch button (S133), and adjust the LED lamp as shown below. Then the LED lamp indicates the current setting.

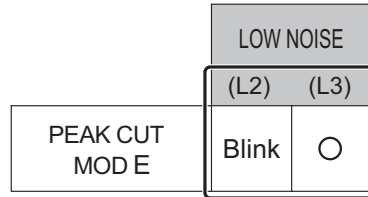

4. Press the ENTER switch button (S132).

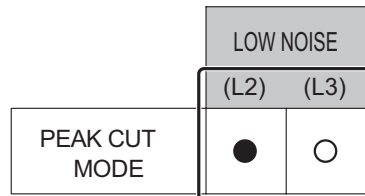

Sign “●”: Lights on

5. Press the SELECT switch button (S133), and adjust the LED lamps as shown below.

	PEAK CUT		
	(L4)	(L5)	(L6)
0 % of rated input ratio	○	○	Blink
50 % of rated input ratio	○	Blink	○
75 % of rated input ratio	○	Blink	Blink
100 % of rated input ratio	Blink	○	○

6. Press the ENTER switch button (S132) and fix it.

	PEAK CUT		
	(L4)	(L5)	(L6)
0 % of rated input ratio	○	○	●
50 % of rated input ratio	○	●	○
75 % of rated input ratio	○	●	●
100 % of rated input ratio	●	○	○

7. To return to “Operating status display (Normal operation)”, press the EXIT switch button (S131).

NOTE: When pressed number is lost during setting, you must redo the setting procedure. Return to “Operation status display (Normal operation)” by pressing the EXIT switch button once, and restart from the beginning of the setting procedure.

3. External input and output (Indoor unit)

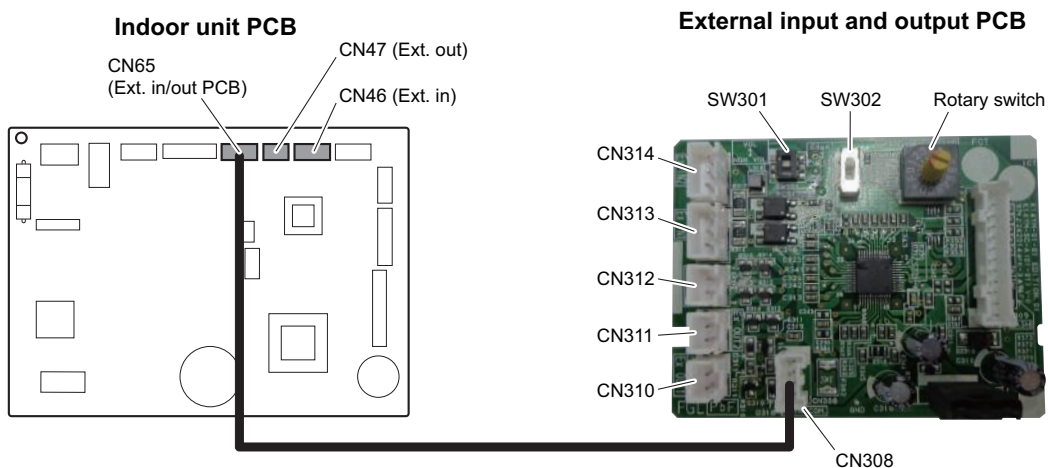

PCB	External input	External output	Connector	Input select	Input signal
Indoor unit	Operation/Stop	—	CN46	Dry contact	Edge
	Forced stop				
	—	Operation status	CN47	—	—
		Error status			
		Indoor unit fan operation status			
		Cooling thermostat On			
		Heating thermostat On			
External heater output					
Setpoint Attainment status					
External input and output (UTY-XCSXZ2)	Operation/Stop	—	CN313/ CN314	Dry contact/ Apply voltage	Edge/Pulse
	Forced stop				
	Forced thermostat off		CN313		Edge
	—	Operation status	CN310/ CN311/ CN312	—	—
		Error status			
		Indoor unit fan operation status			
		External heater output			
Remote controller output					
Cooling high/low output					
Heating thermostat On					

FIELD WORKING

FIELD WORKING

3-1. External input

With using external input function, some functions on this product can be controlled from an external device.

- "Operation/Stop" mode or "Forced stop" mode can be selected with function setting of indoor unit.
- A twisted pair cable (22AWG) should be used. Maximum length of cable is 492 ft (150 m).
- The wire connection should be separate from the power cable line.

■ Indoor unit

Indoor unit functions such as Operation/Stop can be done by using indoor unit connectors.

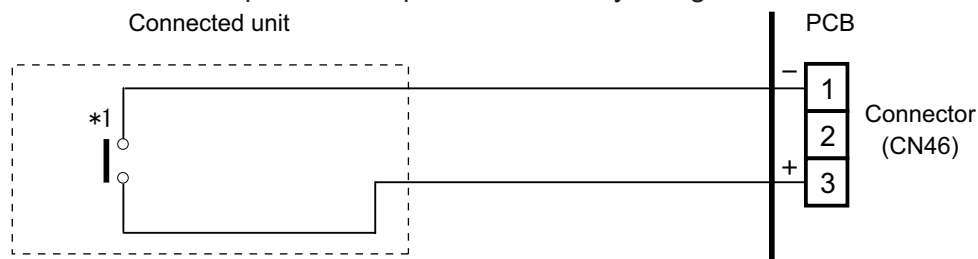

*1: The switch can be used on the following condition: DC 12 V to 24 V, 1 mA to 15 mA.

External Input and Output PCB

The indoor unit Operation/Stop can be set by using the input connector on the PCB.

Input select:

Use either one of these types of connectors according to the application. (Both types of connectors cannot be used simultaneously.)

– Dry contact

In case of internal power supply, set the slide switch of SW301 to "NON VOL" side.

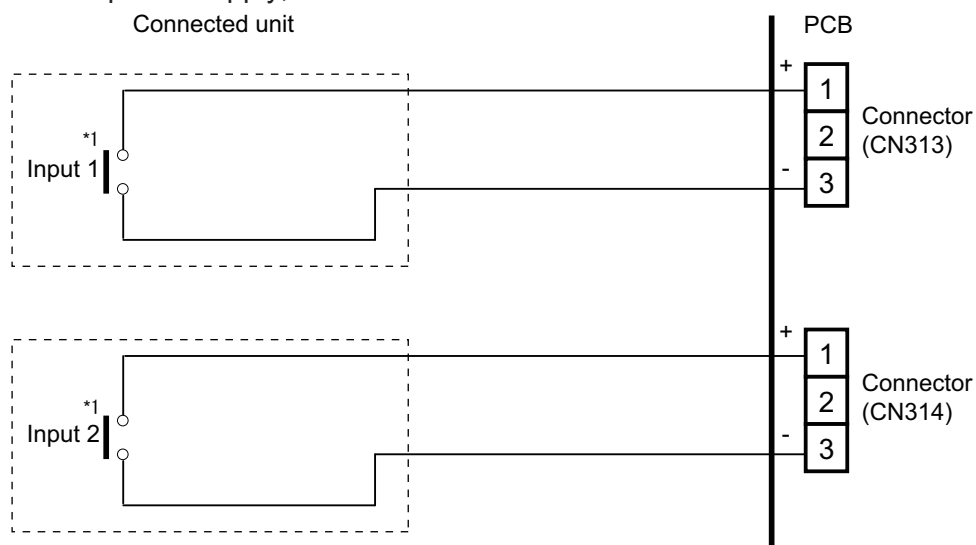

*1: The switches can be used on the following condition: DC 12 V to 24 V, 1 mA to 15 mA.

– Apply voltage

In case of external power supply, set the slide switch of SW301 to "VOL" side.

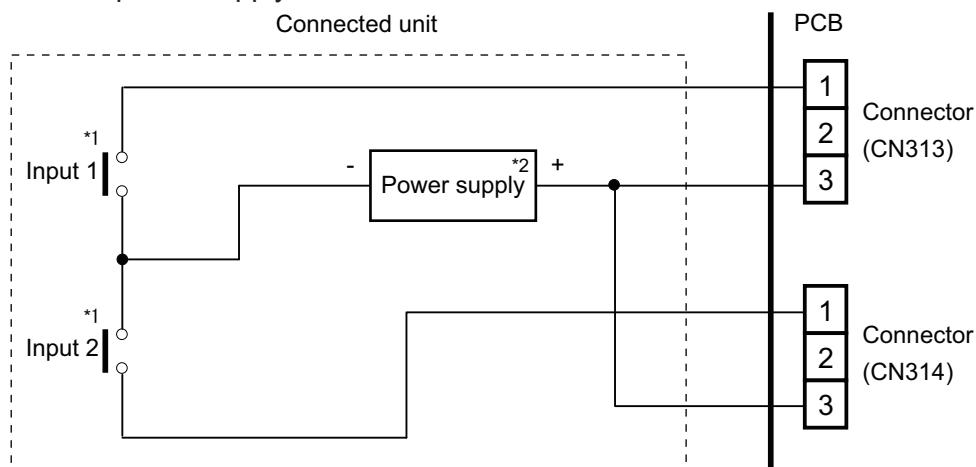

*1: The switches can be used on the following condition: DC 12 V to 24 V, 1 mA to 15 mA.

*2: Make the power supply DC 12 to 24 V, 10 mA or more.

3-2. External output

Use an external output cable with appropriate external dimension, depending on the number of cables to be installed.

Indoor unit

- A twisted pair cable (22AWG) should be used. Maximum length of cable is 82 ft (25 m).
- Output voltage: High DC 12 V \pm 2 V, Low 0 V.
- Permissible current: 50 mA
- For details, refer to ["Combination of external input and output"](#) on page 05-22.

When indicator or other components are connected directly

Example: Function setting 60 is set to "00"

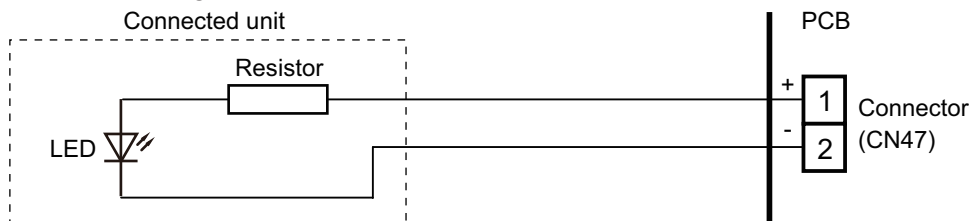

When connecting with a device equipped with a power supply

Example: Function setting 60 is set to "00"

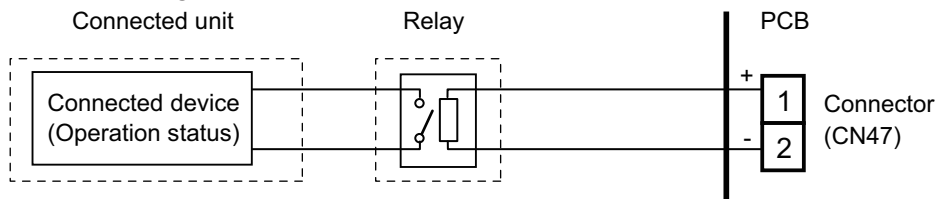

External Input and Output PCB

- A twisted pair cable (22AWG) should be used. Maximum length of cable is 82 ft (25 m).
 - Output voltage: High DC 12 V \pm 2 V, Low 0 V.
 - Permissible current: 50 mA
 - For details, refer to "[Combination of external input and output](#)" on page 05-22.
- **When indicator or other components are connected directly:**
Example: Rotary SW on External Input and Output PCB is set to "1".

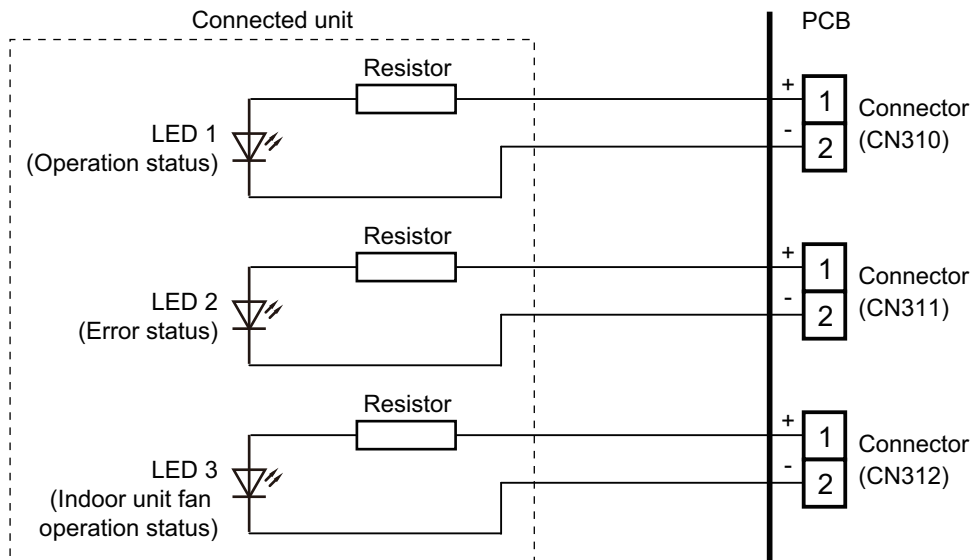

- **When connecting with a device equipped with a power supply:**
Example: Rotary SW on External Input and Output PCB is set to "1".

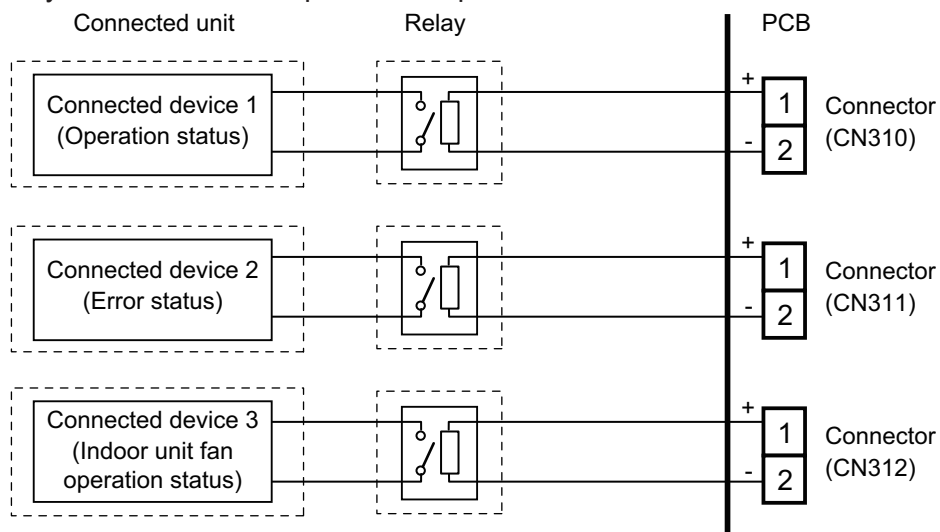

3-3. Combination of external input and output

By combining the function setting of the indoor unit and rotary switch setting of the External Input and Output PCB, you can select various combinations of functions.

Combination examples of external input and output are as follows:

Mode	Function setting	Rotary SW	External input		
			Indoor unit	External Input and Output PCB	
			CN46	1 CN313	2 CN314
0-1	60—00	1	Operation/Stop (Function setting 46-00) or Forced stop (Function setting 46-02)	Operation/Stop	Not available
0-2	60-00	2		Operation	Stop
1	60-01	3		Forced thermostat Off	Not available
2	60-02	4		Mechanical cooling Off	
3	60-03	5		Forced thermostat Off	
4	60-04	6		Mechanical cooling On	
5	60-05	7		Mechanical cooling On	
6	60-06	8		Forced thermostat Off	
7	60-07	9		Forced thermostat Off	
8	60-08	A		Mechanical cooling Off	
9	60-09	B		Forced thermostat Off	
10	60-10	C		Forced thermostat Off	
11	60-11	D	Forced thermostat Off		
12	60-12	D	Forced thermostat Off		

NOTE: Input of Operation/Stop depends on the setting of function setting 46.

- 00: Operation/Stop mode 1 (R.C. enabled)
- 01: (Setting prohibited)
- 02: Forced stop
- 03: Operation/Stop mode 2 (R.C. disabled)

Mode	Function setting	Rotary SW	External output			
			Indoor unit	External Input and Output PCB		
			CN47	1 CN310	2 CN311	3 CN312
0-1	60-00	1	Operation/Stop	Operation/Stop	Error status	Indoor unit fan operation status
0-2	60-00	2	Operation/Stop	Error status	Indoor unit fan operation status	External heater output
1	60-01	3	Cooling thermostat On	Error status	Indoor unit fan operation status	External heater output
2	60-02	4	Cooling thermostat On	Error status	Remote controller output	External heater output
3	60-03	5	Cooling thermostat On	Cooling high/low output	Remote controller output	External heater output
4	60-04	6	Cooling thermostat On	Error status	Remote controller output	Cooling high/low output
5	60-05	7	Heating thermostat On	Error status	Indoor unit fan operation status	External heater output
6	60-06	8	Operation/Stop	Error status	Indoor unit fan operation status	Heating thermostat On
7	60-07	9	Cooling thermostat On	Error status	Heating thermostat On	External heater output
8	60-08	A	Cooling thermostat On	Heating thermostat On	Remote controller output	External heater output
9	60-09	B	Error status	Operation/Stop	Indoor unit fan operation status	External heater output
10	60-10	C	Indoor unit fan operation status	Operation/Stop	Error status	External heater output
11	60-11	D	External heater output	Operation/Stop	Indoor unit fan operation status	Error status
12	60-12	D	Set point attainment status	Operation/Stop	Indoor unit fan operation status	Error status

Input signal type

External Input and Output PCB:

The input signal type can be selected.

Signal type (edge or pulse) can be switched by the DIP switch SW302 on the External Input and Output PCB.

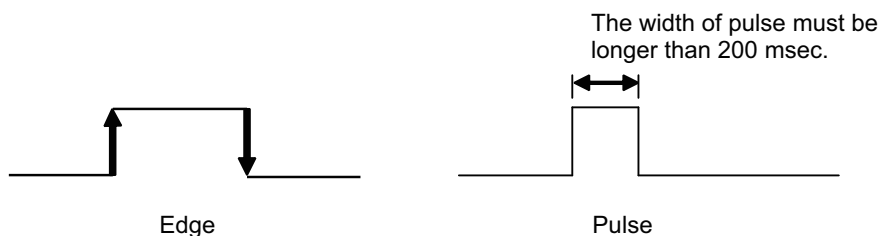

3-4. Details of function

■ Control input function

- When function setting is “Operation/Stop” mode 1
 - In the case of “Edge” input:

Function setting	Rotary SW on External Input and Output PCB	External input		Input signal	Command
		External Input and Output PCB	CN313		
46-00	1			Off → On	Operation
				On → Off	Stop

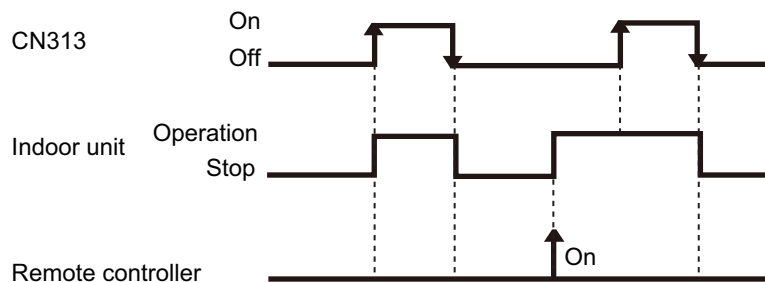

- In the case of “Pulse” input:

Function setting	Rotary SW on External Input and Output PCB	External input		Input signal	Command
		External Input and Output PCB	CN313		
46-00	1		CN313	Pulse	Operation
			CN314	Pulse	Stop

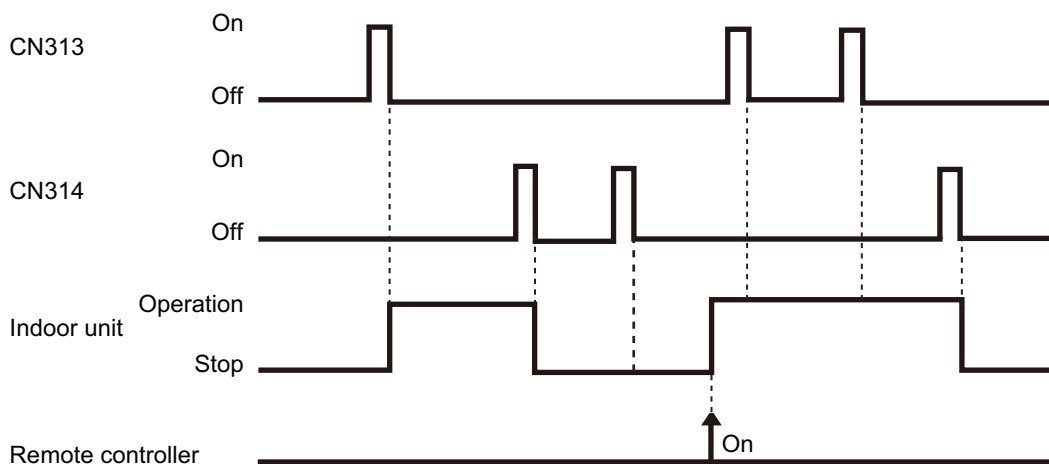

NOTES:

- The last command has priority.
- The indoor units within the same remote controller group operates in the same mode.

• When function setting is “Forced stop” mode

– In the case of “Edge” input:

Function setting	Rotary SW on External Input and Output PCB	External input		Input signal	Command
		External Input and Output PCB	CN313		
46-02	1			Off → On	Forced stop
				On → Off	Normal

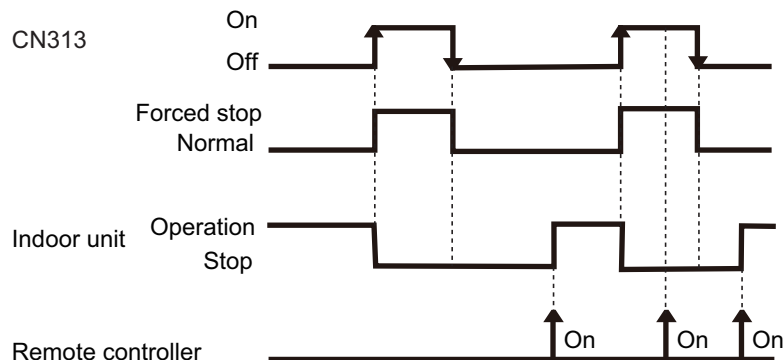

– In the case of “Pulse” input:

Function setting	Rotary SW on External Input and Output PCB	External input		Input signal	Command
		External Input and Output PCB	CN313		
46-02	1		CN313	Pulse	Forced stop
			CN314	Pulse	Normal

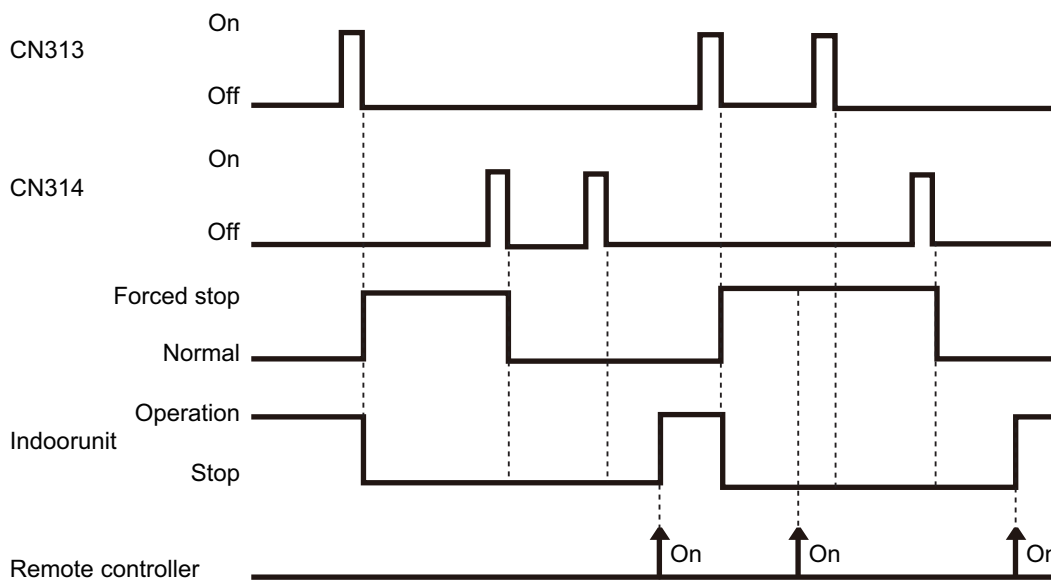

NOTES:

- When the forced stop is triggered, indoor unit stops and Operation/Stop operation by the remote controller is restricted.
- When forced stop function is used with forming a remote controller group, connect the same equipment to each indoor unit within the group.

FIELD WORKING

FIELD WORKING

• When function setting is “Operation/Stop” mode 2

– In the case of “Edge” input:

Function setting	Rotary SW on External Input and Output PCB	External input		Input signal	Command
46-03	1	External Input and Output PCB	CN313	Off → On	Operation
				On → Off	Stop (Remote controller disabled)

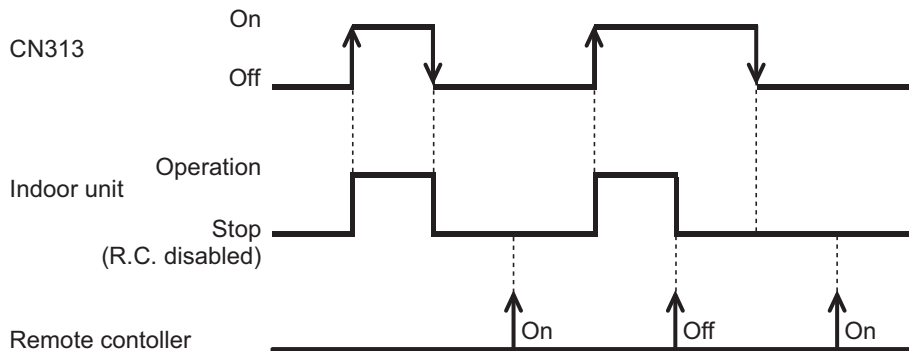

– In the case of “Pulse” input:

Function setting	Rotary SW on External Input and Output PCB	External input		Input signal	Command
46-03	1	External Input and Output PCB	CN313	Pulse	Operation
			CN314	Pulse	Stop (Remote controller disabled)

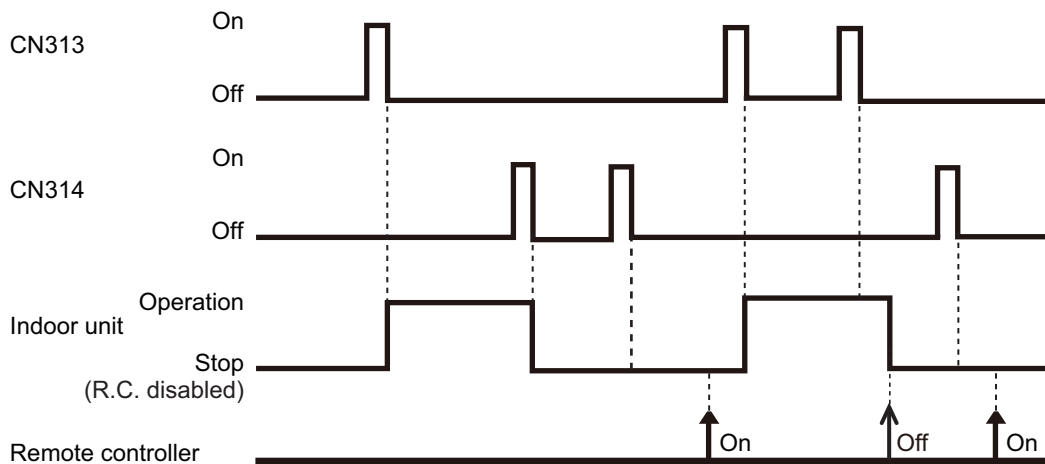

NOTE: When “Operation/Stop” mode 2 function is used with forming a remote controller group, connect the same equipment to each indoor unit within the group.

FIELD WORKING

FIELD WORKING

• Forced thermostat off function

Function setting / Rotary SW on External Input and Output PCB	External input		Input signal	Command
60-00 / 2 60-09 / B 60-10 / C 60-11 / D 60-12 / D	External Input and Output PCB	CN313	Off → On	Thermostat off
On → Off			Normal operation	

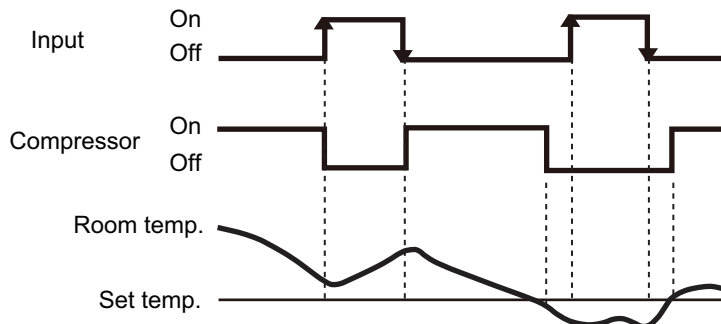

■ Control output function

• Operation/Stop status

Function setting / Rotary SW on External Input and Output PCB	External output		Output signal	Command
60-00 / 2	Output of indoor unit	CN47	Off → On	Operation
			On → Off	Stop
60-00 / 1 60-09 / B 60-10 / C 60-11 / D 60-12 / D	External Input and Output PCB	CN310	Off → On	Operation
			On → Off	Stop

The output is low when the unit is stopped.

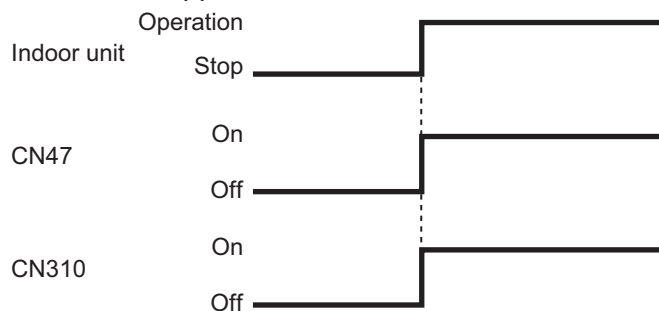

• Error status

Function setting / Rotary SW on External Input and Output PCB	External output		Output signal	Command
60-09 / B	Output of indoor unit	CN47	Off → On	Error
			On → Off	Normal
60-00 / 2	External Input and Output PCB	CN310	Off → On	Error
			On → Off	Normal
60-00 / 1 60-09 / B 60-10 / C		CN311	Off → On	Error
			On → Off	Normal
60-11 / D 60-12 / D		CN312	Off → On	Error
			On → Off	Normal

The output is ON when an error is generated for the indoor unit.

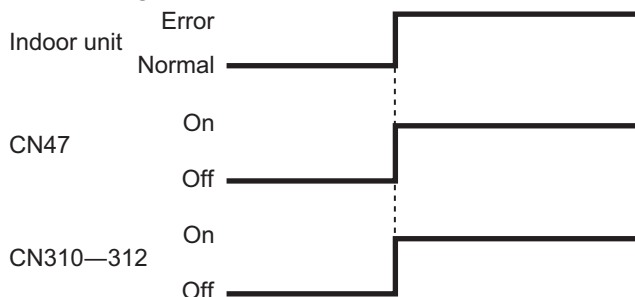

• Indoor unit fan operation status

Function setting / Rotary SW on External Input and Output PCB	External output		Output signal	Command
60-10 / C	Output of indoor unit	CN47	Off → On	Fan run
			On → Off	Fan stop
60-00 / 2 60-09 / B 60-11 / D 60-12 / D	External Input and Output PCB	CN311	Off → On	Fan run
			On → Off	Fan stop
60-00 / 1		CN312	Off → On	Fan run
			On → Off	Fan stop

Output signal	Condition
On Low → High	The indoor unit fan is operating.
Off High → Low	The fan is stopped or during cold air prevention. During thermostat off when in dry mode operation.

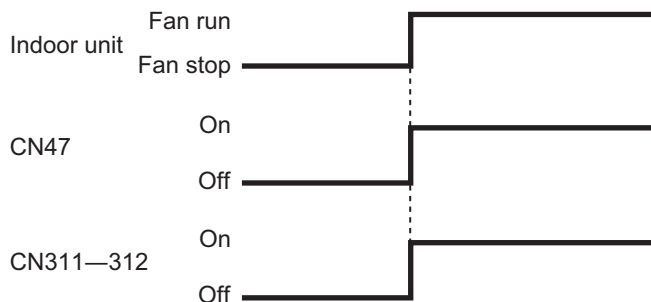

- External heater output

Function setting / Rotary SW on External Input and Output PCB	External output		Output signal	Command
60-11 / D	Output of indoor unit	CN47	Off → On	Heater on
			On → Off	Heater off
60-00 / 2 60-09 / B 60-10 / C	External Input and Output PCB	CN312	Off → On	Heater on
			On → Off	Heater off

- Setpoint Attainment status

NOTE: This function is valid only when function setting 96 is set to “Enable” (01).

When the room temperature does not reach the setpoint at a room due to the lower cooling performance caused by external factor such as the outdoor temperature change, signal is output to tell the attainment status of setpoint.

Function setting / Rotary SW on External Input and Output PCB	External output		Output signal	Command
60-12 / D	Output of indoor unit	CN47	On → Off	Normal
			Off → On	Setpoint Attainment

Output signal	Condition
Off	Reached the setpoint. ($Tr \leq Ts\alpha + 1^{\circ}\text{F}$ [0.5°C])
On	Unreached the setpoint. ($Tr > Ts\alpha + 5^{\circ}\text{F}$ [2.5°C]) However, even if the setpoint unreached, the signal will not be output for 7 minutes after power is turned on.

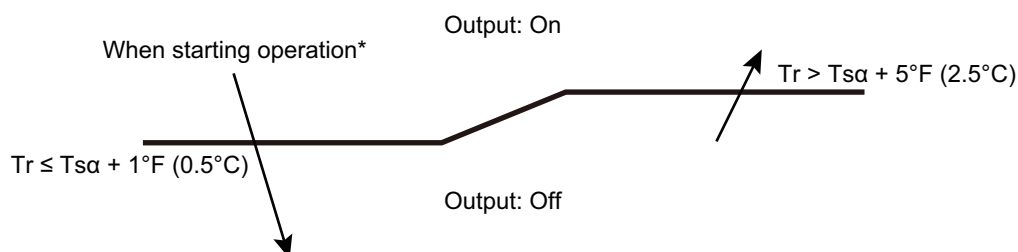

*: When starting operation or resetting, judges the zone to descending direction.

External heater output

Control	Primary heater	Auxiliary heater	Function setting	
			Indoor unit	Wired R. C.
			Control switching external heaters No. 61	Sensor activation*2
Auxiliary heater control 1	Heat pump	External device*1	61-00	—
Auxiliary heater control 2	Heat pump	External device	61-01	—
Heat pump prohibition control	External device	None	61-02	On (Enabled)
Auxiliary heater control by outdoor temperature 1	Heat pump	External device	61-03	On (Enabled)
Auxiliary heater control by outdoor temperature 2	Heat Pump	External device	61-04	On (Enabled)
Auxiliary heater control by outdoor temperature 3	Heat Pump	External device	61-05	On (Enabled)
Auxiliary heat pump control	External device	Heat pump	61-06	On (Enabled)
Auxiliary heat pump control by outdoor temperature 1	External device	Heat pump	61-07	On (Enabled)
Auxiliary heat pump control by outdoor temperature 2	External device	Heat pump	61-08	On (Enabled)
Auxiliary heat pump control by outdoor temperature 3	External device	Heat pump	61-09	On (Enabled)

NOTES:

- After turning off the heater, 3 minutes of standby time is required by next power-on of the heater.
- For items marked “—” in the table, any of validate or invalidate of the setting are acceptable.
- *1: External device means Hot water, Electrical heater, etc.
- *2: Sensor activation:
 - Setting change from the factory setting is required.
 - Indoor unit fan setting will be on for safety reason without sensor activation of wired remote controller.

Installation configuration of individual connection

External heating device is installed individually. (No use of indoor unit fan)

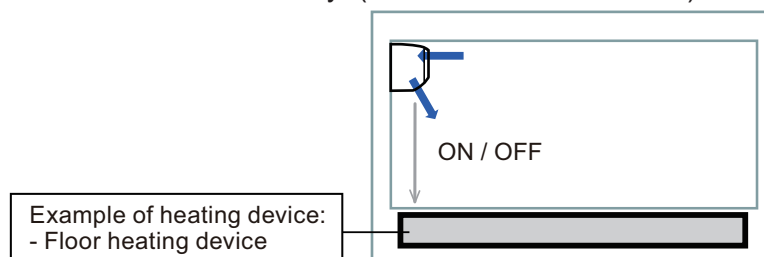

⚠ WARNING

- Design and install external heater appropriately with considering its protection.
- Inappropriate designing and installation of external heater may cause a fire by emitted heat from the external heater.
- Fujitsu General Ltd. is not responsible for inappropriate designing or installation of external heating device.

● Auxiliary heater control 1

Operation	Condition
Heater on	Heater is on as shown in following diagram of heating temperature.
Heater off	<ul style="list-style-type: none"> • Heater is off as shown in following diagram of heating temperature. • Other than heating mode • Error occurred • Forced thermostat off • Fan stop protection

- Temperature of heater on (Thon): Adjustable by function number 62 (Operating temperature switching of external heaters).
- All control temperatures will shift by adjusting “Thon”.

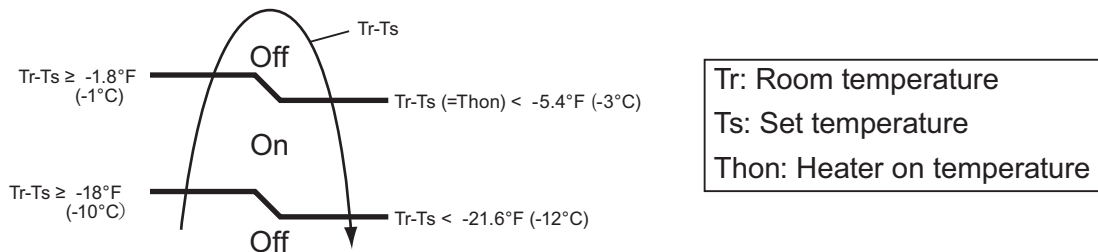

Example: When set temperature (Ts) is 72°F (22°C) (Factory setting),

- and room temperature (Tr) increases above 53.6°F (12°C), signal output is on.
- and room temperature (Tr) increases above 69.8°F (21°C), signal output is off.
- and room temperature (Tr) decreases below 66.2°F (19°C), signal output is on.
- and room temperature (Tr) decreases below 50°F (10°C), signal output is off.

● Auxiliary heater control 2

Operation	Condition
Heater on	Heater is on as shown in following diagram of heating temperature.
Heater off	<ul style="list-style-type: none"> • Heater is off as shown in following diagram of heating temperature. • Other than heating mode • Error occurred • Forced thermostat off • Fan stop protection

- Temperature of heater on (Thon): Adjustable by function number 62 (Operating temperature switching of external heaters).
- All control temperatures will shift by adjusting “Thon”.

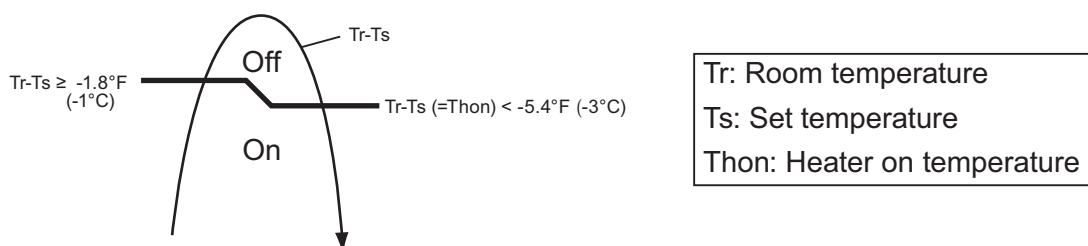

● Heat pump prohibition control

Perform heating by external heater only. Indoor unit is continuous thermostat off.

Operation	Condition
Heater on	Heater is on as shown in following diagram of heating temperature.
Heater off	<ul style="list-style-type: none"> • Heater is off as shown in following diagram of heating temperature. • Other than heating mode • Error occurred • Forced thermostat off

- Temperature of heater on (Thon): Adjustable by function number 62 (Operating temperature switching of external heaters).
- All control temperatures will shift by adjusting “Thon”.

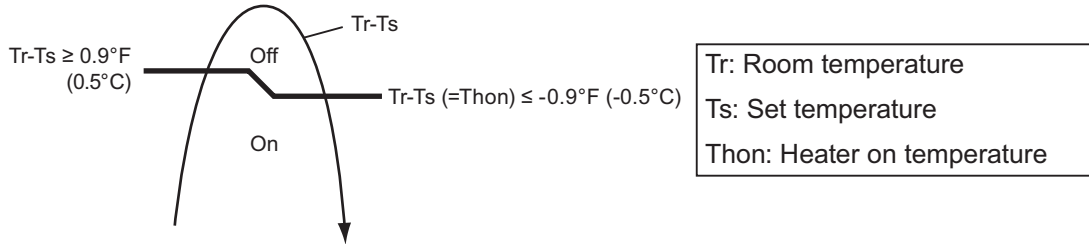

• Operation status

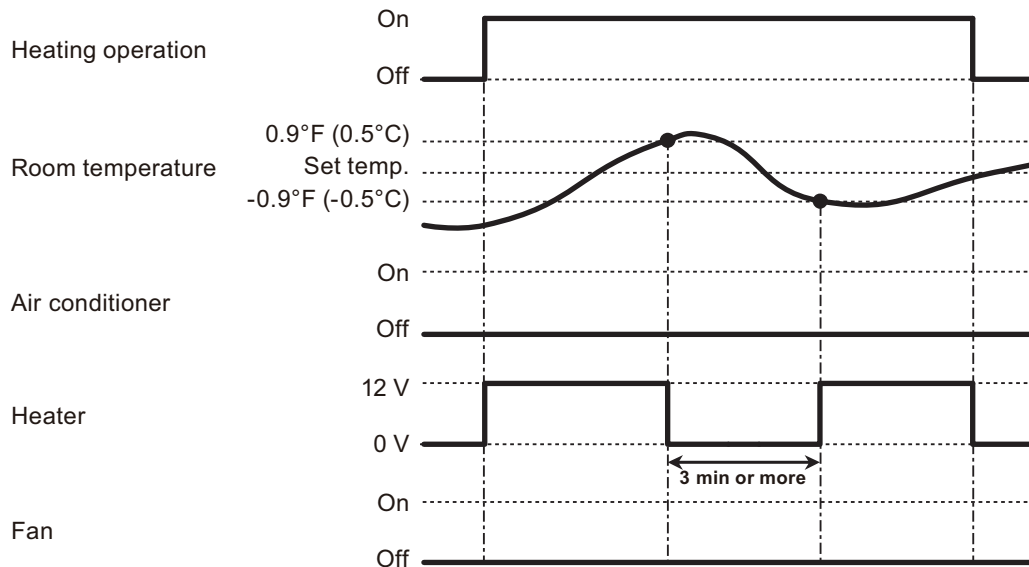

NOTE: In following operations, compressor will be on.

- Other than heating
- Test run

● Auxiliary heater control by outdoor temperature 1

This control selects heat pump or external heater according to the outdoor temperature. When outdoor temperature is high, the heating is performed by using heat pump only.

Operation	Condition
Heater on	Heater is on as shown in following diagram of heating temperature.
Heater off	<ul style="list-style-type: none"> • Heater is off as shown in following diagram of heating temperature. • Other than heating mode • Error occurred • Forced thermostat off • Heat pump only zone

- Temperature of heater on (Thon): Adjustable by function number 62 (Operating temperature switching of external heaters).
- All control temperatures will shift by adjusting "Thon".
- Outdoor temperature zone boundary A and B: Adjustable individually by function setting number 66 and 67.

• External heater output

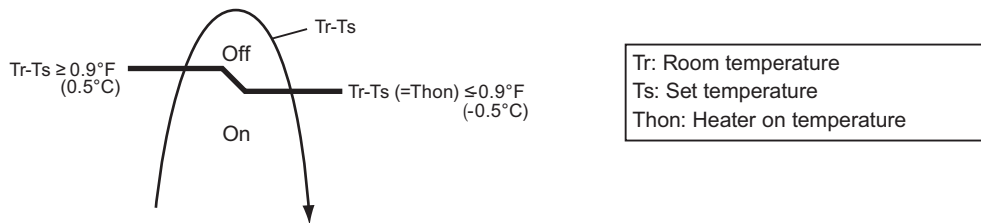

• Outdoor temperature zone

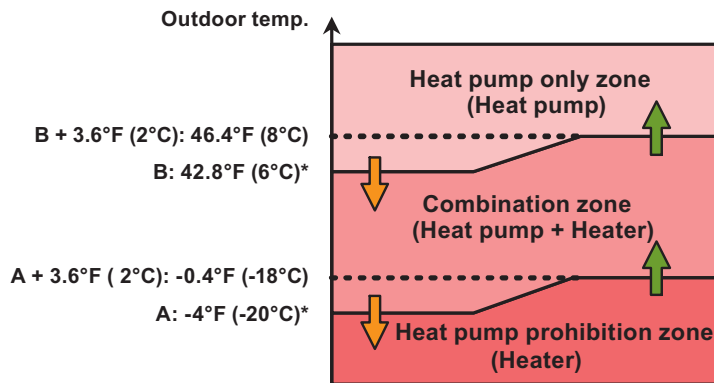

*: Adjustable by function setting 66 and 67

FIELD WORKING

FIELD WORKING

• Operation status

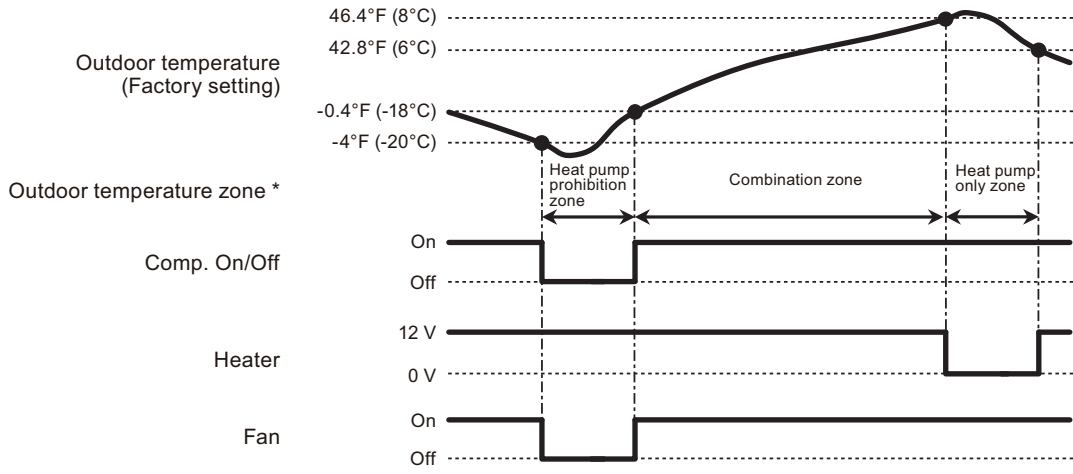

* The outdoor temperature zone transition from one to another will stay in that zone for minimum of 30 min.

NOTE: In following operations, compressor will be on in heat pump prohibition zone.

- Other than heating
- Test run

FIELD WORKING

FIELD WORKING

● Auxiliary heater control by outdoor temperature 2

This control selects heat pump or external heater according to the outdoor temperature. Even when outdoor temperature is high, the heating is performed by using both of heat pump and external heater.

Operation	Condition
Heater on	Heater is on as shown in following diagram of heating temperature.
Heater off	<ul style="list-style-type: none"> • Heater is off as shown in following diagram of heating temperature. • Other than heating mode • Error occurred • Forced thermostat off

- Temperature of heater on (Thon): Adjustable by function number 62 (Operating temperature switching of external heaters).
- All control temperatures will shift by adjusting “Thon”.
- Outdoor temperature zone boundary A: Adjustable by function setting number 66.

• External heater output

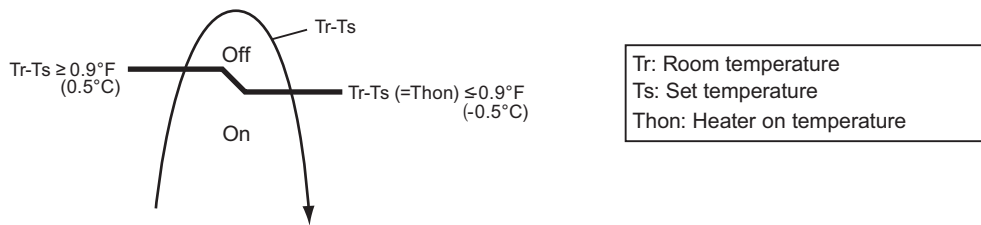

• Outdoor temperature zone

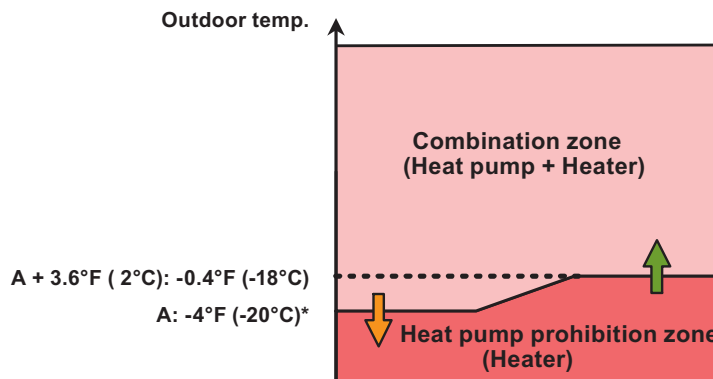

*: Adjustable by function setting 66

• Operation status

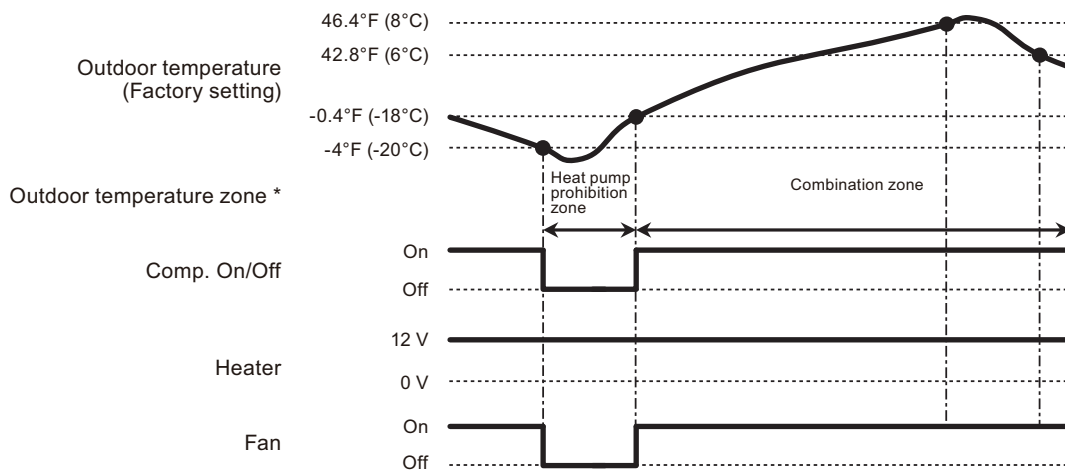

* The outdoor temperature zone transition from one to another will stay in that zone for minimum of 30 min.

NOTE: In following operations, compressor will be on in heat pump prohibition zone.

- Other than heating
- Test run

● Auxiliary heater control by outdoor temperature 3

This control selects heat pump or external heater according to the outdoor temperature. Even when outdoor temperature is high, the heating is performed by using both of heat pump and external heater.

Operation	Condition
Heater on	Heater is on as shown in following diagram of heating temperature.
Heater off	<ul style="list-style-type: none"> • Heater is off as shown in following diagram of heating temperature. • Other than heating mode • Error occurred • Forced thermostat off

- Temperature of heater on (Thon): Adjustable by function number 62 (Operating temperature switching of external heaters).
- All control temperatures will shift by adjusting “Thon”.
- Outdoor temperature zone boundary B: Adjustable by function setting number 67.

• External heater output

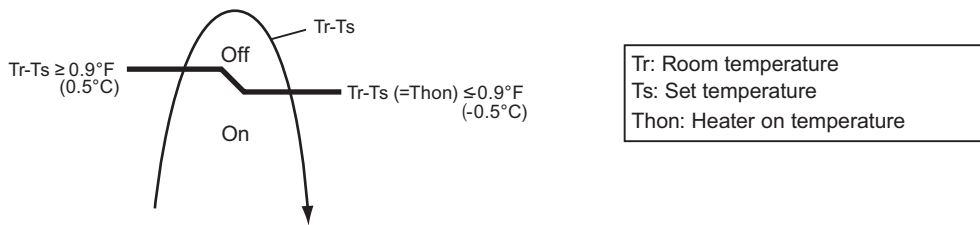

• Outdoor temperature zone

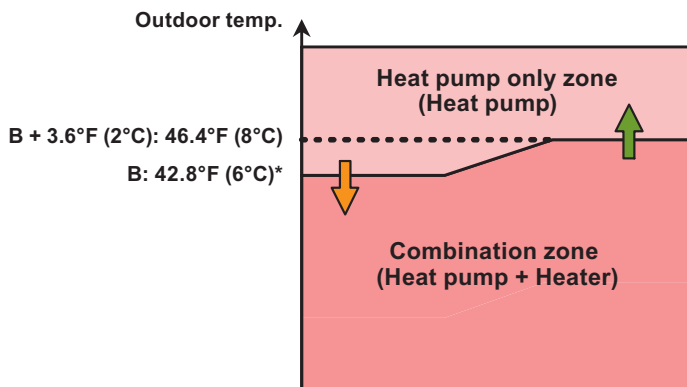

*: Adjustable by function setting 67

FIELD WORKING

FIELD WORKING

• Operation status

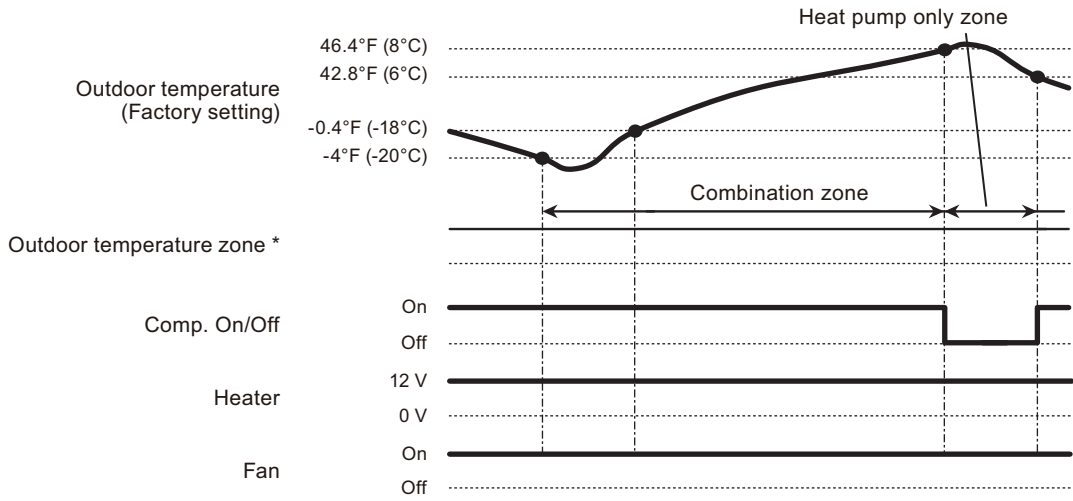

* The outdoor temperature zone transition from one to another will stay in that zone for minimum of 30 min.

NOTE: In following operations, compressor will be on in heat pump prohibition zone.

- Other than heating
- Test run

FIELD WORKING

FIELD WORKING

● Auxiliary heat pump control

• External heater output

Operation	Condition
Heater on	Heater is on as shown in following diagram of heating temperature.
Heater off	<ul style="list-style-type: none"> • Heater is off as shown in following diagram of heating temperature. • Other than heating mode • Error occurred • Forced thermostat off

- Temperature of heater on (Thon): Set temperature (Ts) - 0.9 °F (- 0.5 °C)
- Temperature of heater off: Set temperature (Ts) + 0.9 °F (+ 0.5 °C)

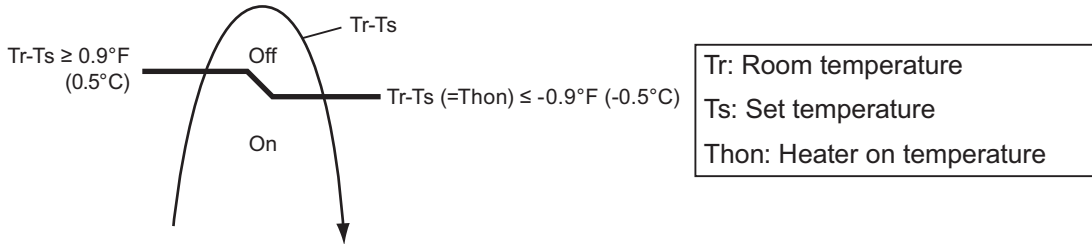

• Auxiliary heat pump On/Off

- Temperature of heater on (Thon): Adjustable by function number 62 (Operating temperature switching of heat pump).
- All control temperatures will shift by adjusting “Thon”.

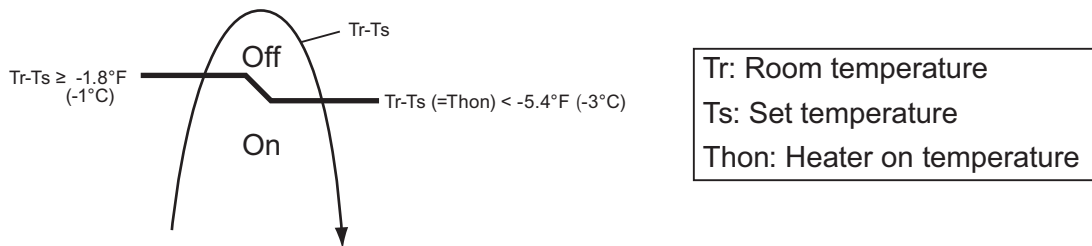

● Auxiliary heat pump control by outdoor temperature 1

• External heater output

Operation	Condition
Heater on	Heater is on as shown in following diagram of heating temperature.
Heater off	<ul style="list-style-type: none"> • Heater is off as shown in following diagram of heating temperature. • Other than heating mode • Error occurred • Forced thermostat off

- Temperature of heater on (Thon): Set temperature (Ts) - 0.9 °F (- 0.5 °C)
- Temperature of heater off: Set temperature (Ts) + 0.9 °F (+ 0.5 °C)

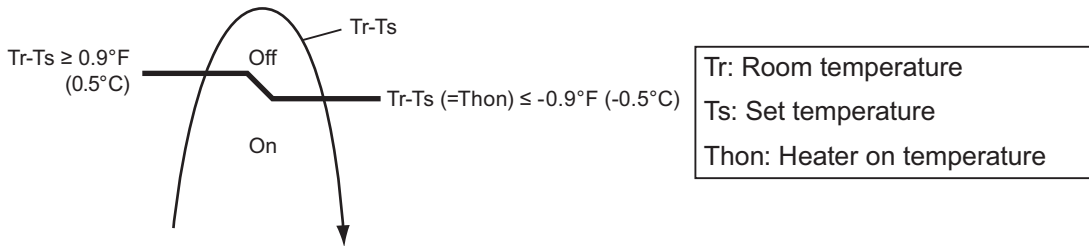

• Auxiliary heat pump On/Off

- Temperature of heater on (Thon): Adjustable by function number 62 (Operating temperature switching of heat pump).
- All control temperatures will shift by adjusting “Thon”.

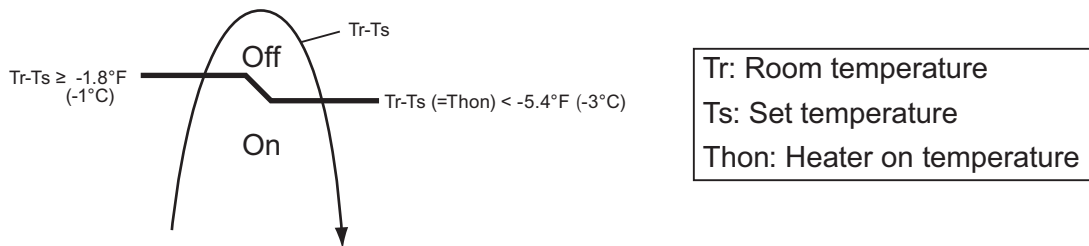

• Outdoor temperature zone

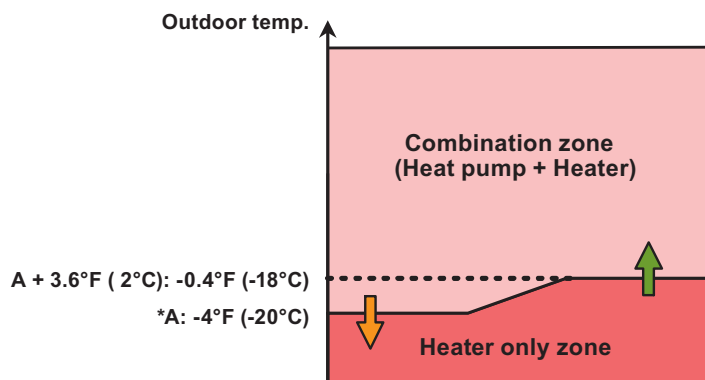

*: Adjustable by function setting 66

• Operation status

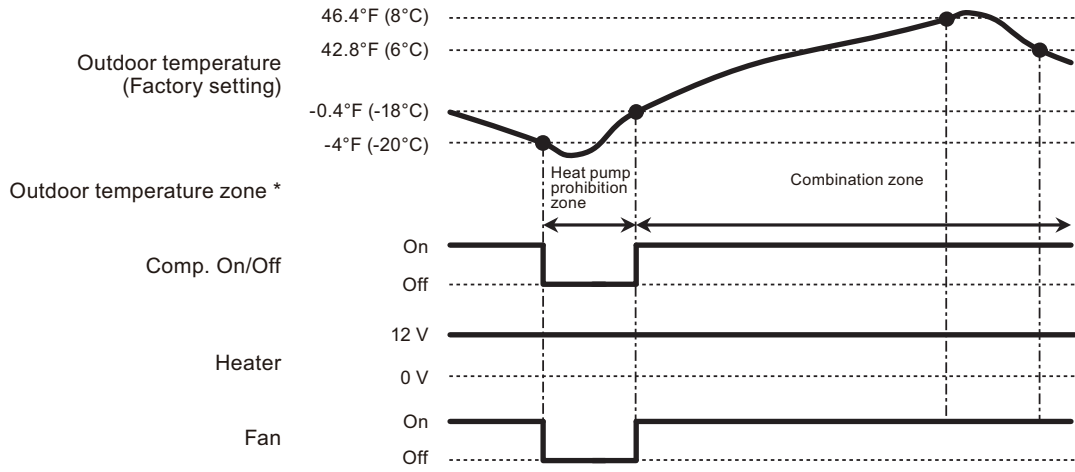

* The outdoor temperature zone transition from one to another will stay in that zone for minimum of 30 min.

NOTE: In following operations, compressor will be on in heat pump prohibition zone.

- Other than heating
- Test run

FIELD WORKING

FIELD WORKING

● Auxiliary heat pump control by outdoor temperature 2

• External heater output

Operation	Condition
Heater on	Heater is on as shown in following diagram of heating temperature.
Heater off	<ul style="list-style-type: none"> • Heater is off as shown in following diagram of heating temperature. • Other than heating mode • Error occurred • Forced thermostat off

- Temperature of heater on (Thon): Set temperature (Ts) - 0.9 °F (- 0.5 °C)
- Temperature of heater off: Set temperature (Ts) + 0.9 °F (+ 0.5 °C)

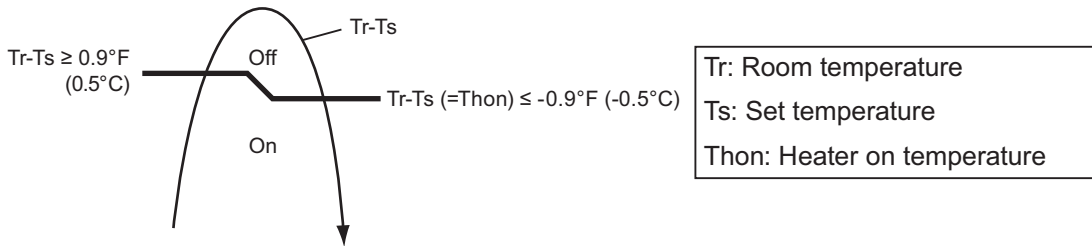

• Auxiliary heat pump On/Off

- Temperature of heater on (Thon): Adjustable by function number 62 (Operating temperature switching of heat pump).
- All control temperatures will shift by adjusting “Thon”.

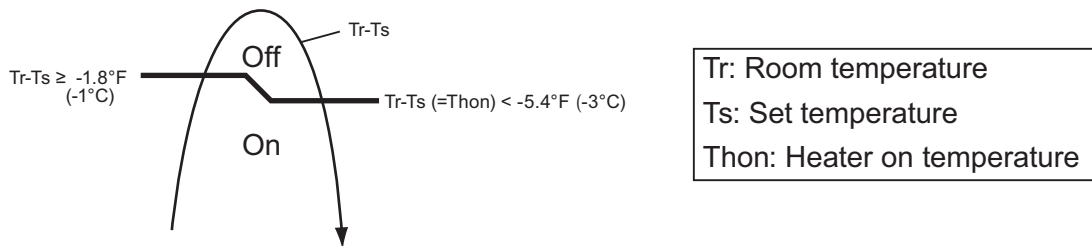

• Outdoor temperature zone

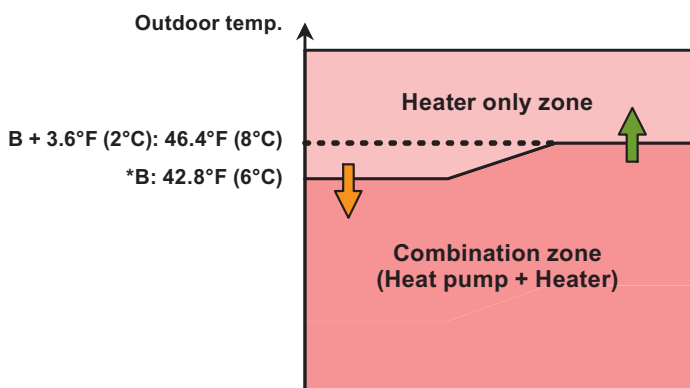

*: Adjustable by function setting 67

• Operation status

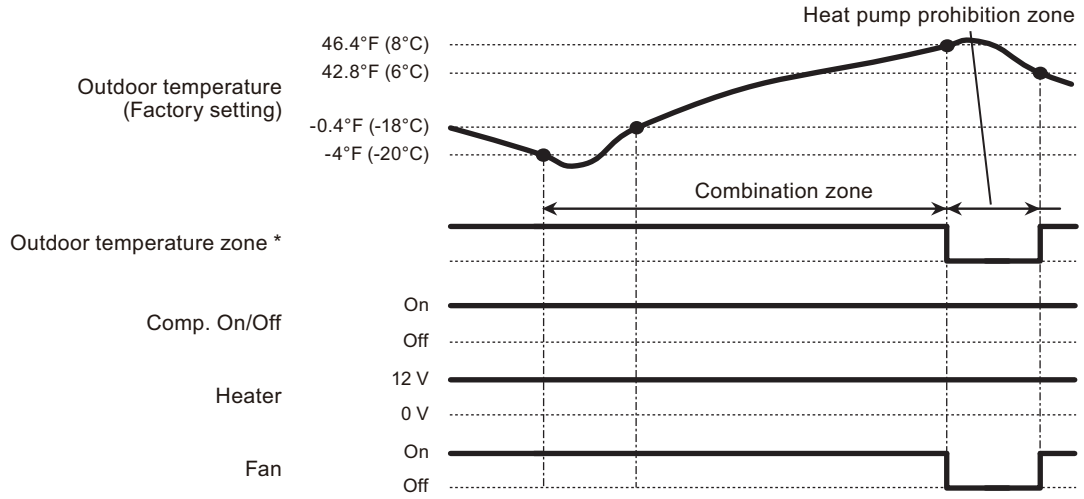

* The outdoor temperature zone transition from one to another will stay in that zone for minimum of 30 min.

NOTE: In following operations, compressor will be on in heat pump prohibition zone.

- Other than heating
- Test run

FIELD WORKING

FIELD WORKING

● Auxiliary heat pump control by outdoor temperature 3

• External heater output

Operation	Condition
Heater on	Heater is on as shown in following diagram of heating temperature.
Heater off	<ul style="list-style-type: none"> • Heater is off as shown in following diagram of heating temperature. • Other than heating mode • Error occurred • Forced thermostat off

- Temperature of heater on (Thon): Set temperature (Ts) - 0.9 °F (- 0.5 °C)
- Temperature of heater off: Set temperature (Ts) + 0.9 °F (+ 0.5 °C)

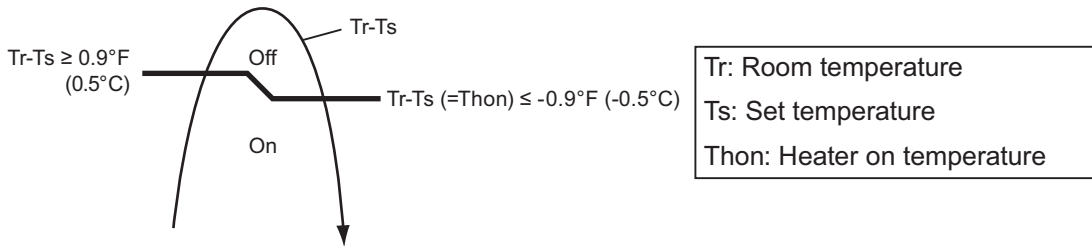

• Auxiliary heat pump On/Off

- Temperature of heater on (Thon): Adjustable by function number 62 (Operating temperature switching of heat pump).
- All control temperatures will shift by adjusting “Thon”.

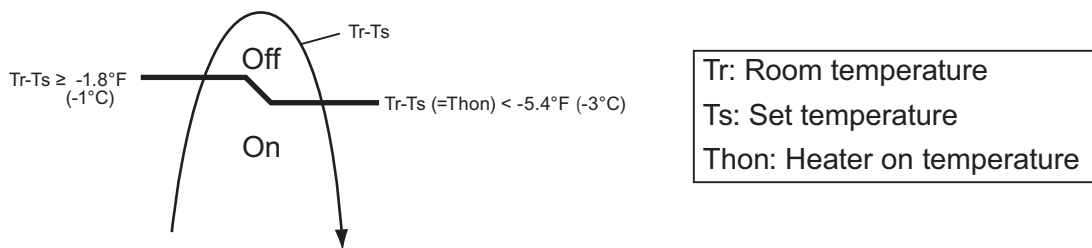

• Outdoor temperature zone

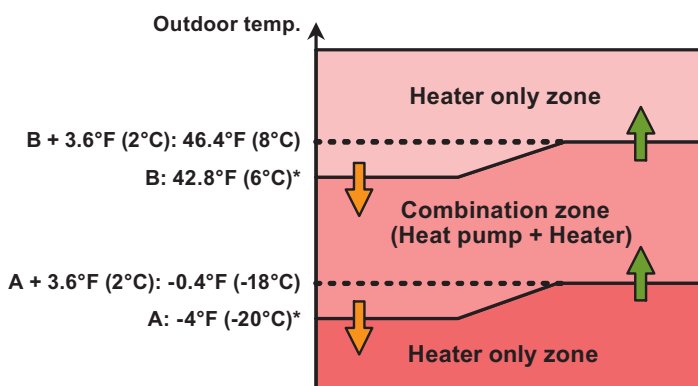

*: Adjustable by function setting 66 and 67

FIELD WORKING

FIELD WORKING

• Operation status

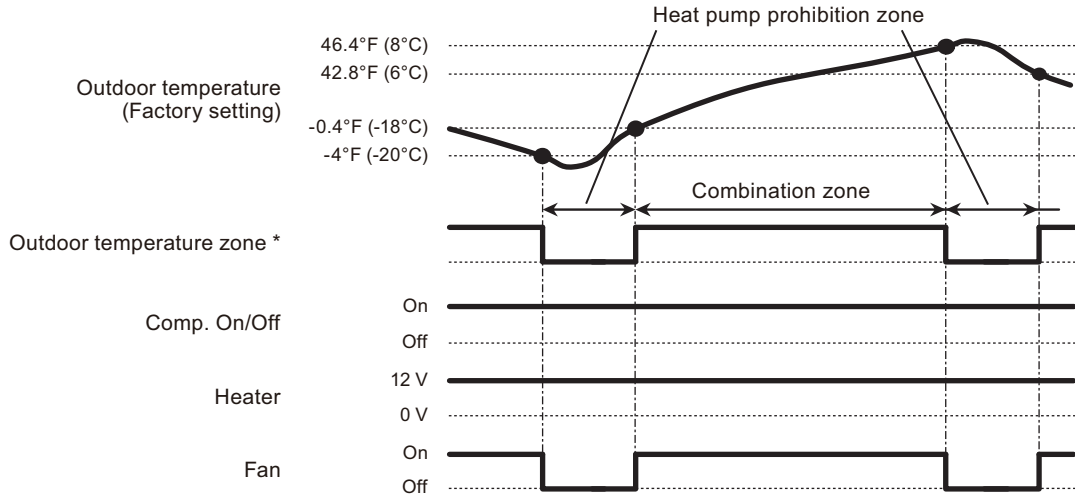

* The outdoor temperature zone transition from one to another will stay in that zone for minimum of 30 min.

NOTE: In following operations, compressor will be on in heat pump prohibition zone.

- Other than heating
- Test run

FIELD WORKING

FIELD WORKING

■ Heating thermostat on for humidifier

Situation	Indoor unit				
	Mode	Function setting	Rotary SW	External output	
		Heating thermostat on no. 60		Heating thermostat on	Indoor unit fan operation status
Example of individual connection	5	60-05	7	CN47	Not used
	6	60-06	8	CN312	
	7	60-07	9	CN311	
	8	60-08	A	CN310	

- Example of individual connection

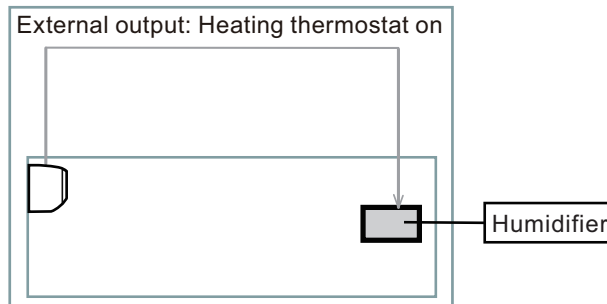

- Operation status

The heating thermostat output for CNB01 (1-2 or 1-3 or 1- or 1-5) will be on when comp on or external heater on.

The heating thermostat output will be off when comp off and external heater off.

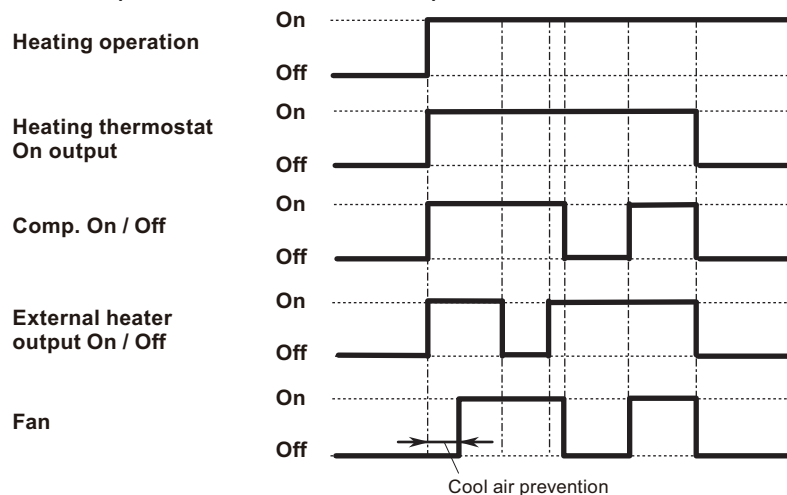

4. External input and output (Outdoor unit)

With using external input and output functions, this product can be operated inter-connectedly with an external device.

Connector	Input	Output	Remarks
P580	Low noise mode	—	See external input/output settings for details.
PA580	Peak cut mode	—	
P590	—	Error status	
PA590	—	Compressor status	

4-1. External input

With using external input function, on/off status of “Low noise mode” and “Peak cut mode” can be specified by the external signal.

■ Low noise mode

In following condition, the operating noise of the outdoor unit reduces comparing from the one in normal operating condition:

The air conditioner is set to the “Low noise mode” when closing the contact input of a commercial timer or on/off switch to a connector on the control PCB of the outdoor unit.

NOTE: Product performance may drop depending on some conditions such as the outdoor temperature.

• Circuit diagram example

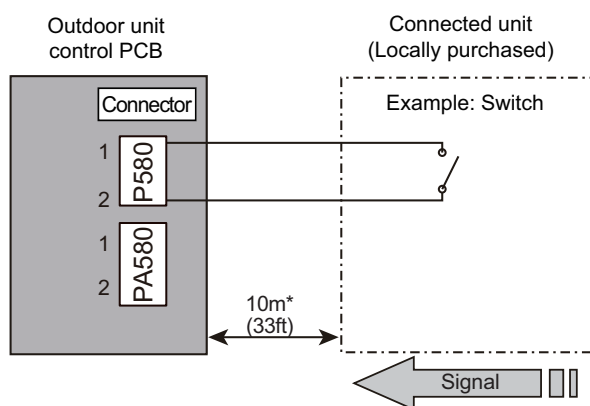

- Contact capacity: DC 24 V or more, 10 mA or more.
- *: Make the distance from the PCB to the connected unit within 33 ft (10 m).
- Construct a circuit as shown in this figure with using optional parts mentioned below.
- Input signal: On in “Low noise mode”
- Input signal: Off in normal operation
- To set the level of “Low noise mode”, refer to “Low noise mode” in ["Local setting procedure"](#) on page 05-15.

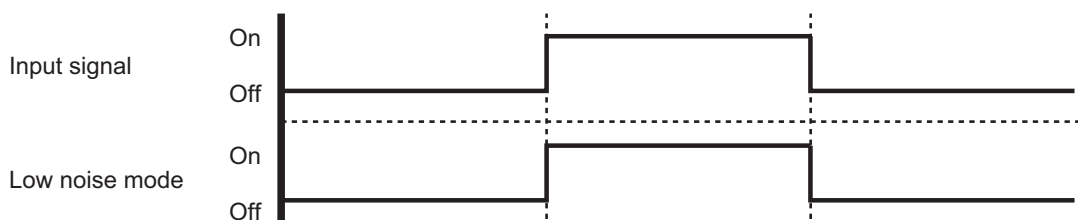

• Optional part

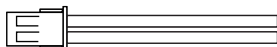
Part name	Model name	Exterior
External Connect Kit	UTY-XWZXZ3	External input wire 

■ Peak cut mode

By performing following on-site work, operation that suppresses the current value can be enabled: The air conditioner is set to the “Peak cut mode” when closing the contact input of a commercial timer or on/off switch to a connector on the control PCB of the outdoor unit.

• Circuit diagram example

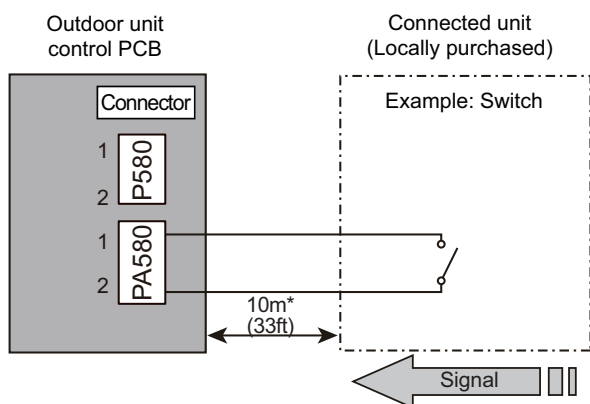

- Contact capacity: DC 24 V or more, 10 mA or more.
- *: Make the distance from the PCB to the connected unit within 33 ft (10 m).
- Construct a circuit as shown in this figure with using optional parts mentioned below.
- Input signal: On in “Peak cut mode”
- Input signal: Off in normal operation
- To set the level of “Peak cut mode”, refer to **“Peak cut mode”** on page 05-16.

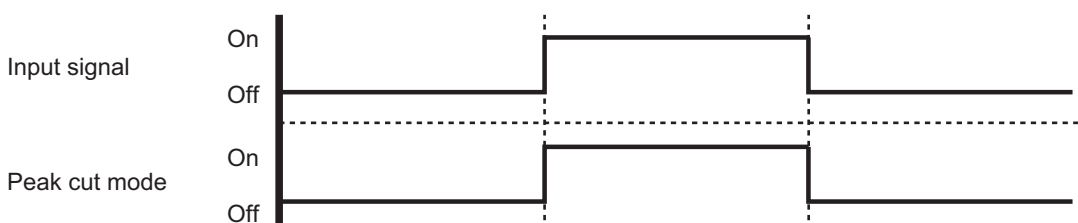

• Optional part

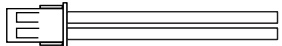
Part name	Model name	Exterior
External Connect Kit	UTY-XWZXZ3	External input wire 

4-2. External output

With using external output function, some status signals are transmitted to the control PCB, and the related LED lamp indicates the status of this product.

■ Error status output

Signal on air conditioner error status is generated when a malfunction occurs.

• Circuit diagram example

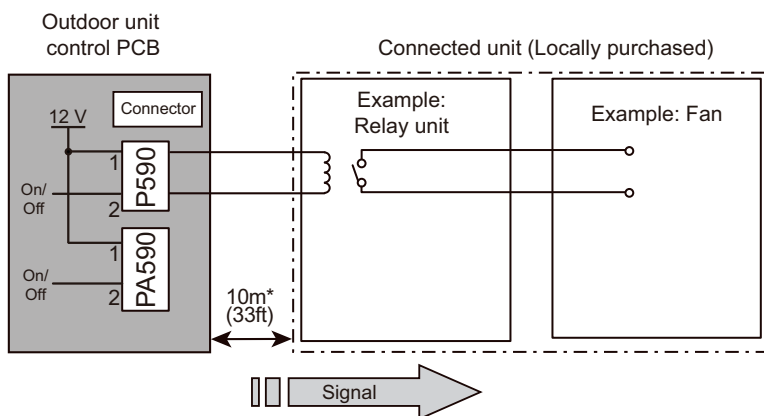

- Output voltage (Vcc): DC 12 V 50 mA or less
- *: Make the distance from the PCB to the connected unit within 33 ft (10 m).

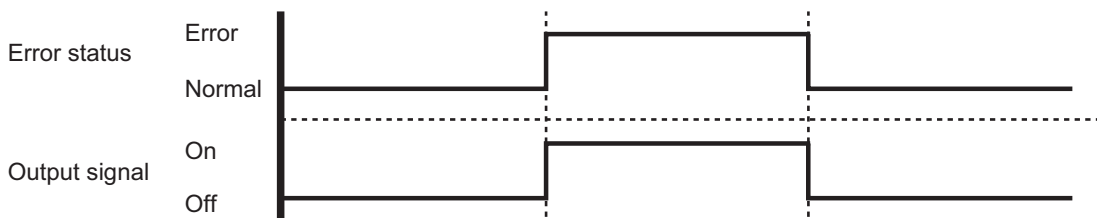

• Optional part

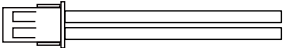
Part name	Model name	Exterior
External Connect Kit	UTY-XWZXZ3	External output wire 

FIELD WORKING

FIELD WORKING

■ Compressor status output

Signal on compressor operation status is generated when the compressor is running.

• Circuit diagram example

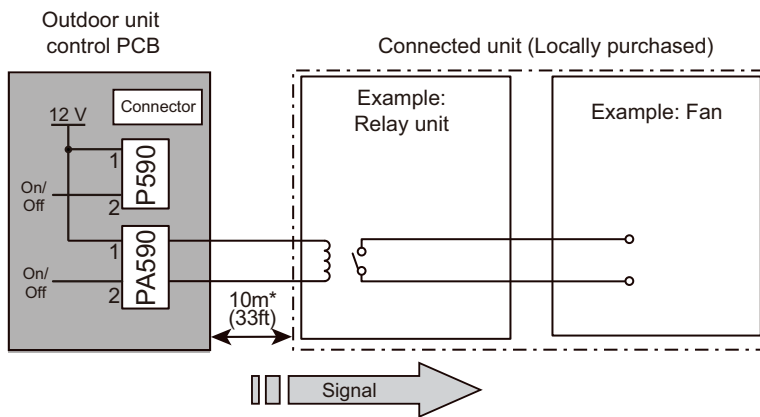

- Output voltage (Vcc): DC 12 V 50 mA or less
- *: Make the distance from the PCB to the connected unit within 33 ft (10 m).

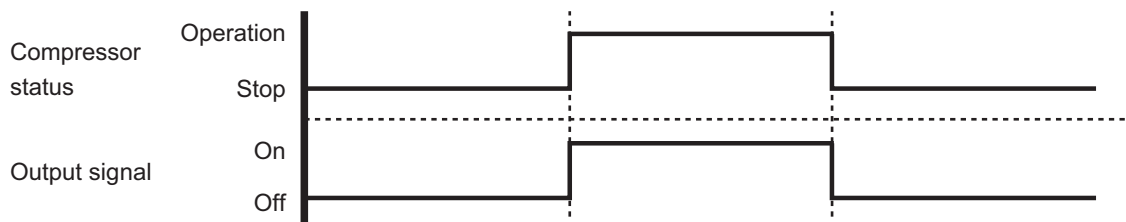

• Optional part

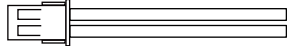
Part name	Model name	Exterior
External Connect Kit	UTY-XWZXZ3	External output wire 

FIELD WORKING

FIELD WORKING