

AIR CONDITIONER

Multi: 4 rooms type

DESIGN & TECHNICAL MANUAL

For Extra Cold Climate Area



AUU7/9/12/18RLF



ARU7/9/12RLF



ARU18RLF



ARU24RLF

INDOOR



ASU7/9/12/15RLF1



ASU18/24RLF



AGU9/12/15RLF

OUTDOOR



AOU36RLXFZH

Notices:

- Product specifications and design are subject to change without notice for future improvement.
- For further details, please check with our authorized dealer.

CONTENTS

Part 1. INDOOR UNIT 1

1. Product features	2
1-1. Model lineup	2
1-2. Features	4
1-3. Control system design	13
1-4. Outdoor unit	14
2. Remote controller	16
2-1. Wireless remote controller (UTY-LNHUM)	16
2-2. Wireless remote controller (AR-REG1U)	19
2-3. Wired remote controller (UTY-RNNUM)	23
2-4. Simple remote controller (UTY-RSNUM)	30
2-5. Central remote controller (UTY-DMMUM)	37
3. Specifications	43
3-1. Compact cassette type	43
3-2. Slim duct type	44
3-3. Wall mounted type	46
3-4. Floor type	48
4. Dimensions	49
4-1. Compact cassette type	49
4-2. Slim duct type	51
4-3. Wall mounted type	56
4-4. Floor type	60
5. Wiring diagrams	61
5-1. Compact cassette type	61
5-2. Slim duct type	62
5-3. Wall mounted type	63
5-4. Floor type	65
6. Air velocity and temperature distributions	66
6-1. Compact cassette type	66
6-2. Slim duct type	72
6-3. Wall mounted type	82
6-4. Floor type	89
7. Fan performance	90
7-1. Slim duct type	90
8. Airflow	100
8-1. Compact cassette type	100
8-2. Slim duct type	101
8-3. Wall mounted type	102
8-4. Floor type	103
9. Noise level curve	104
9-1. Compact cassette type	104

CONTENTS (continued)

9-2. Slim duct type	106
9-3. Wall mounted type	109
9-4. Floor type	112
9-5. Sound level check point	114
10. Electrical characteristics	116
11. Safety devices	117
12. External input and output	118
12-1.External input	118
12-2.External output	121
13. Function settings	128
13-1.Indoor unit (setting by jumper wire)	128
13-2.Indoor unit (setting by wireless remote controller)	129
13-3.Indoor unit (setting by wired remote controller)	142
13-4.Indoor unit (setting by simple remote controller)	145
13-5.Function details	149
13-6.Wired remote controller	154
13-7.Simple remote controller	156
13-8.Central remote controller	157
14. Accessories	158
14-1.Compact cassette type	158
14-2.Slim duct type	160
14-3.Wall mounted type	161
14-4.Floor type	163
15. Optional parts	164
15-1.Controller	164
15-2.Cassette grille	165
15-3.Others	166
16. Installation precautions	169
16-1.Indoor unit installation precautions	169

CONTENTS (continued)

Part 2. OUTDOOR UNIT173

1. Specifications	174
1-1. Model: AOU36RLXFZH	174
2. Dimensions	175
2-1. Model: AOU36RLXFZH	175
3. Installation space	176
3-1. Model: AOU36RLXFZH	176
4. Refrigerant circuit	179
4-1. Model: AOU36RLXFZH	179
5. Wiring diagram	180
5-1. Model: AOU36RLXFZH	180
6. Capacity table	181
6-1. Combinations	181
6-2. Cooling capacity	185
6-3. Heating capacity	205
7. Capacity compensation rate for pipe length and height difference	223
7-1. Model: AOU36RLXFZH	223
8. Additional charge calculation	227
8-1. Model: AOU36RLXFZH	227
9. Airflow	228
9-1. Model: AOU36RLXFZH	228
10. Operation noise (sound pressure)	229
10-1.Noise level curve	229
10-2.Sound level check point	230
11. Electrical characteristics	231
12. Safety devices	232
13. Function settings	233
13-1.Setting methods	233
13-2.Base heater forced off function	236
13-3.Outdoor unit low noise operation function (option)	236
14. Check and test	237
14-1.Check run	237
14-2.Test run	243
14-3.Error code	245
14-4.Pump down	248
15. Accessories	250
16. Optional parts	251
17. Installation precautions	252

CONTENTS (continued)

17-1.Outdoor unit installation precautions	252
--------------------------------------------------	-----

Part 1. INDOOR UNIT

COMPACT CASSETTE TYPE:

AUU7/9/12/18RLF

SLIM DUCT TYPE:

ARU7/9/12/18/24RLF

WALL MOUNTED TYPE:

ASU7/9/12/15RLF1

ASU18/24RLF









FLOOR TYPE:

AGU9/12/15RLF

1. Product features

Implemented core technology provides easy-to-use product operations that realize a comfortable space.

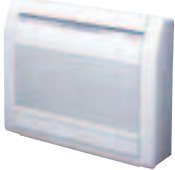
1-1. Model lineup

Indoor unit		
AUU7RLF AUU9RLF AUU12RLF AUU18RLF	ARU7RLF ARU9RLF ARU12RLF	ARU18RLF
		
ARU24RLF	ASU7RLF1 ASU9RLF1 ASU12RLF1 ASU15RLF1	ASU18RLF ASU24RLF
		
AGU9RLF AGU12RLF AGU15RLF		
		
Outdoor unit		
AOU36RLXFZH		
		

● Indoor units that can be connected to each outdoor unit

●: Connectable / -: Not connectable

Outdoor unit		Compact cassette				Slim duct					Wall mounted				Floor				
		AUU7—18RLF				ARU7—24RLF					ASU7—15RLF1				ASU18—24RLF		AGU9—15RLF		
	Btu class	7	9	12	18	7	9	12	18	24	7	9	12	15	18	24	9	12	15
4 rooms	AOU36RLXFZH	●	●	●	●	●	●	●	●	●	●	●	●	●	●	●	●	●	●

■ Indoor unit connection patterns

● 4 rooms

AOU36RLXFZH					
No.	Room 1	Room 2	Room 3	Room 4	Total
1	18	18	—	—	36
2	7	24	—	—	31
3	9	24	—	—	33
4	12	24	—	—	36
5	15	24	—	—	39
6	7	7	15	—	29
7	7	7	18	—	32
8	7	7	24	—	38
9	7	9	12	—	28
10	7	9	15	—	31
11	7	9	18	—	34
12	7	12	12	—	31
13	7	12	15	—	34
14	7	12	18	—	37
15	9	9	9	—	27
16	9	9	12	—	30
17	9	9	15	—	33
18	9	9	18	—	37
19	9	12	12	—	33
20	9	12	15	—	36
21	9	12	18	—	39
22	12	12	12	—	36
23	12	12	15	—	39
24	7	7	7	7	28
25	7	7	7	9	30
26	7	7	7	12	33
27	7	7	7	15	36
28	7	7	7	18	39
29	7	7	9	9	32
30	7	7	9	12	35
31	7	7	9	15	38
32	7	7	12	12	38
33	7	9	9	9	34
34	7	9	9	12	37
35	9	9	9	9	36

7: 7,000 Btu/h, 9: 9,000 Btu/h, 12: 12,000 Btu/h, 15: 14,000 Btu/h, 18: 18,000 Btu/h,
24: 24,000 Btu/h

1-2. Features

■ Compact cassette type

● Models: AUU7RLF, AUU9RLF, AUU12RLF, and AUU18RLF



• 2-stage turbo fan

High efficiency design by 2 stage structure

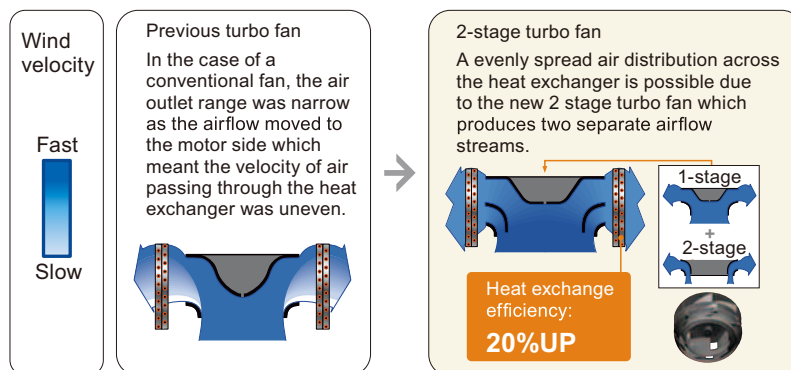

• Quiet quality

Optimization of wing form (laminar wing type) and wing number (7 blades each)

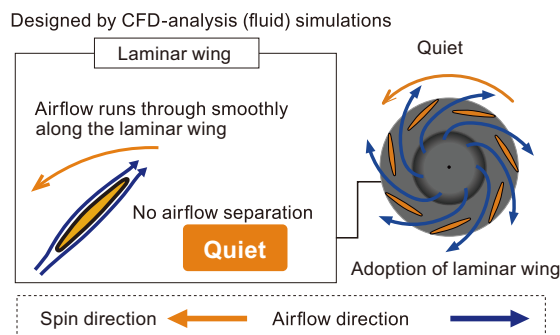

• Easy maintenance

1 Maintenance of fan motor and fan

Maintenance of the fan motor and fan can be done easily after taking off the panel as the bell mouth of the fan can be removed easily.

- A: Fan motor
- B: 2-stage turbo fan
- C: Bell-mouth
- D: Panel

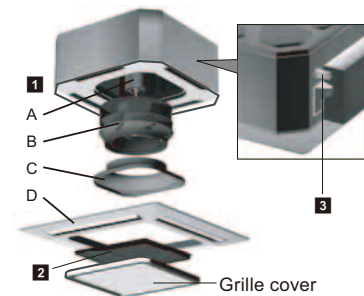

2 Air filter

Standard equipment

3 Adaption of transparent drainage parts

During installation, maintenance and operation, the drain pump and kit can be checked easily.

- **Compact design**

Easy installation by taking off ceiling panel of 23-5/8 in × 23-5/8 in (600 mm × 600 mm) size.

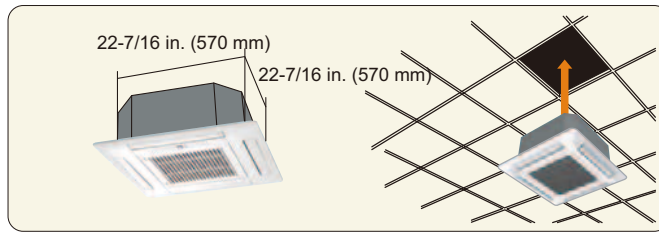

- **High lift drain pump**

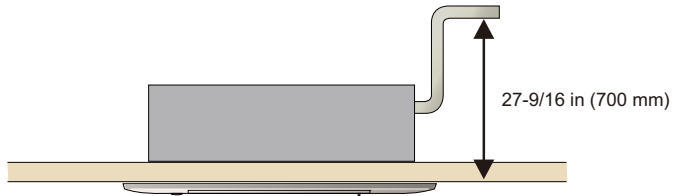

■ Slim duct type

- Models: ARU7RLF, ARU9RLF, ARU12RLF, ARU18RLF, and ARU24RLF



Slim design and wide range of static pressure for flexible installation.

- **Slim design**

This model is slim design, it can install at the place where a ceiling is narrow.

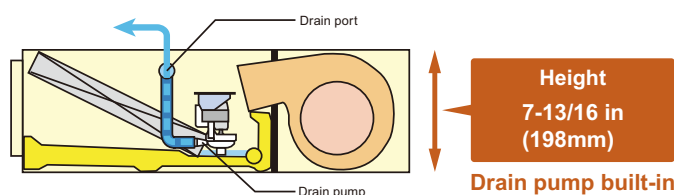

- **Compact design**

Condensate lift-up to 33-7/16 in.

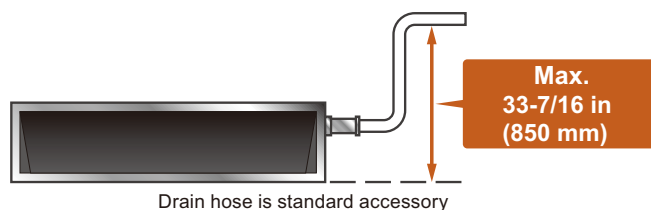

- **Selectable with a wide range of static pressure**

By using DC fan motor, it is possible to change of static pressure range 0 to 0.36 inWG (0 to 90 Pa). The change of static pressure range is possible by remote controller.

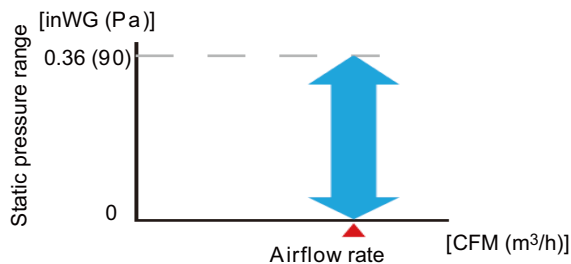

* 24 model is 0 to 0.20 inWG (0 to 50 Pa).

- **Air intake**

Air intake direction can be selected to match the installation site.

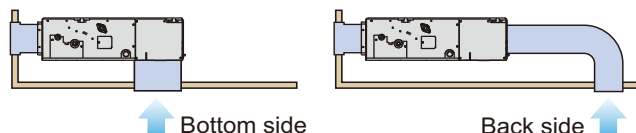

- Flexible installation

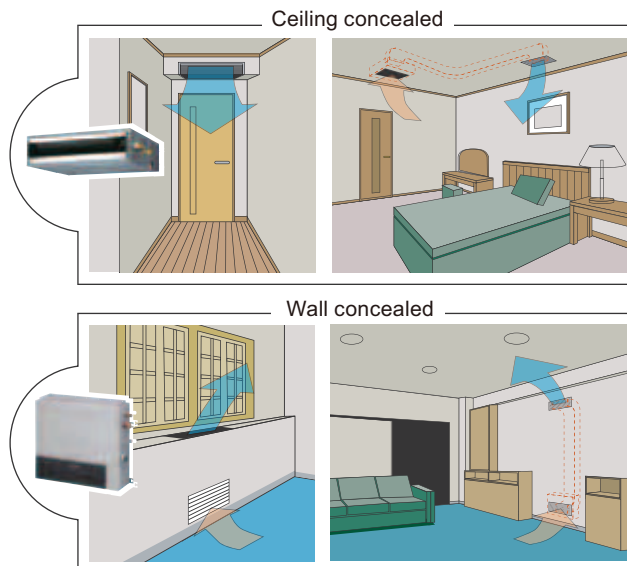

- Filter (Accessory)

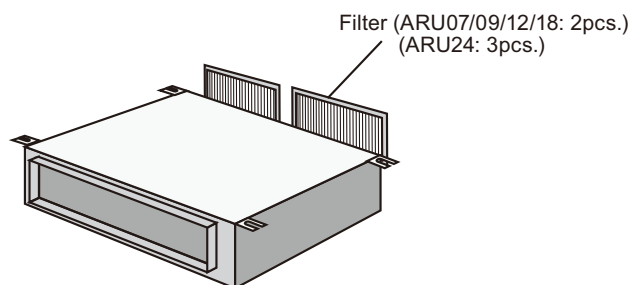

■ Wall mounted type

- Models: ASU7RLF1, ASU9RLF1, ASU12RLF1, and ASU15RLF1



- High efficient compact design

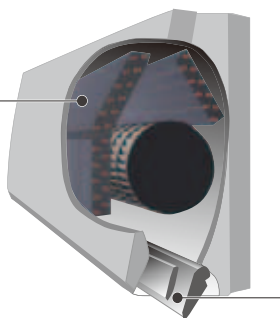
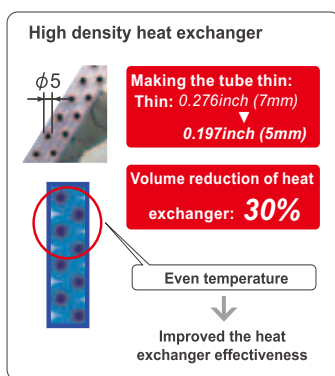

- More comfortable airflow

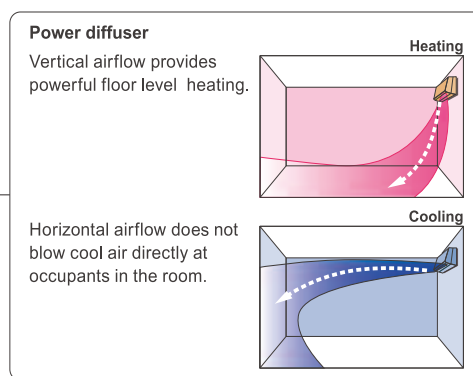

- Quiet operation

Airflow mode can be set in 4 steps and more detailed airflow setting is possible. 21 dB only at cooling operation (22 dB at heating operation).

Fan speed	Noise level
Quiet	21 dB(A)

(7/9/12 TYPE)

- **MIN. HEAT Operation**

*Not operable from the wired remote controller that is connected individually.

The room temperature can be set to go no lower than 50 °F (10 °C), thus ensuring that the room does not get too cold when not occupied.

⚠ CAUTION

- When the room temperature is higher than 50 °F (10 °C), "MIN. HEAT" operation does not start. Operation starts and maintains the room temperature at 50 °F (10 °C) when the temperature drops below 50 °F (10 °C).
- When "MIN. HEAT" operation stops, the room set temperature quickly returns to the preset temperature.

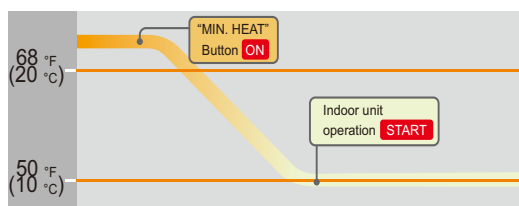

- **Powerful operation**

*Only available with Wireless RC.

20 minutes continuous operation by maximum airflow and maximum compressor speed is possible. Rapid cooling and heating makes the room comfortable quickly.

● Models: ASU18RLF and ASU24RLF

Simple and elegant appearance design

- Compact and slim design

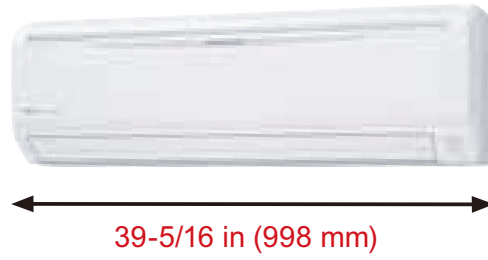

- "Vertical airflow" provides powerful floor level heating

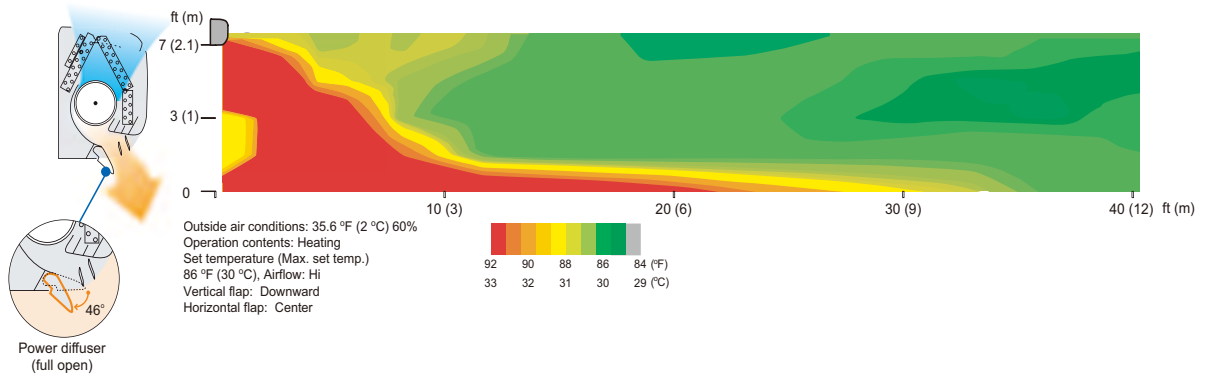

- "Horizontal airflow" does not blow cool air directly at the occupants in the room

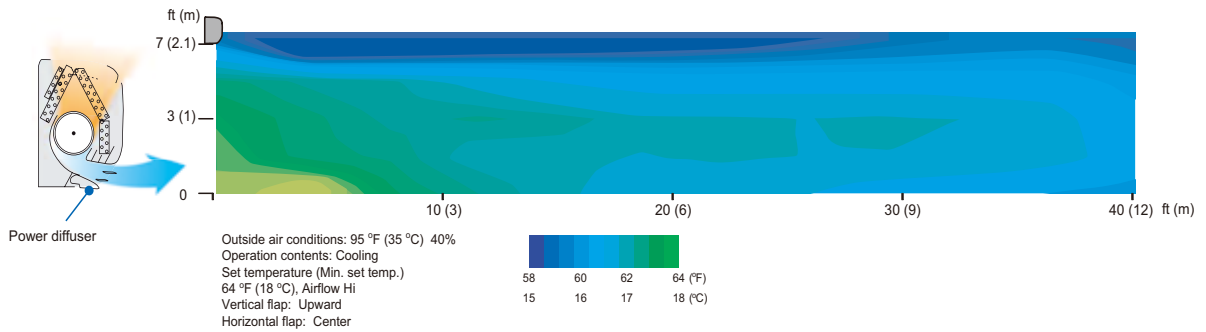

• **Air conditioner filter features**

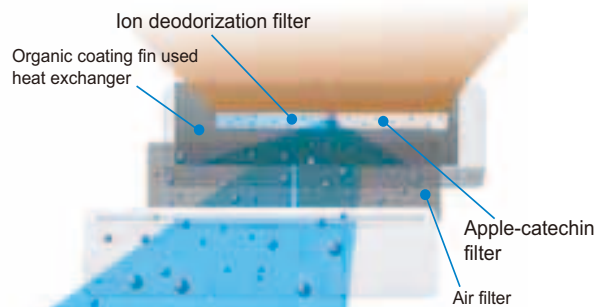

Long-life* Ion deodorization filter



The filter deodorizes by powerfully decomposing absorbed odors using the oxidizing and reducing effects of ions generated by the ultra-fine-particle ceramic.

(*The filter can be used for approx. 3 years if it is washed under water to restore its surface action when it is dirty.)



Using different filters at both sides

Apple-catechin filter



Fine dust, invisible mold spores, and harmful microorganisms are absorbed onto the filter by static electricity, and further growth is inhibited and deactivated by the polyphenol extracted from apples.

• **Easy maintenance**

Simplification of drain pan cleaning improves maintenance-ability.

■ Floor type

● Models: AGU9RLF, AGU12RLF, and AGU15RLF

- 2-fan and wide airflow

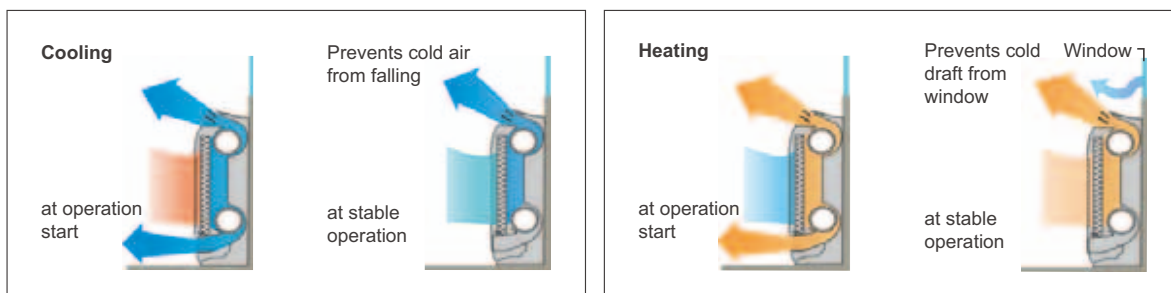

- Flexible and easy installation

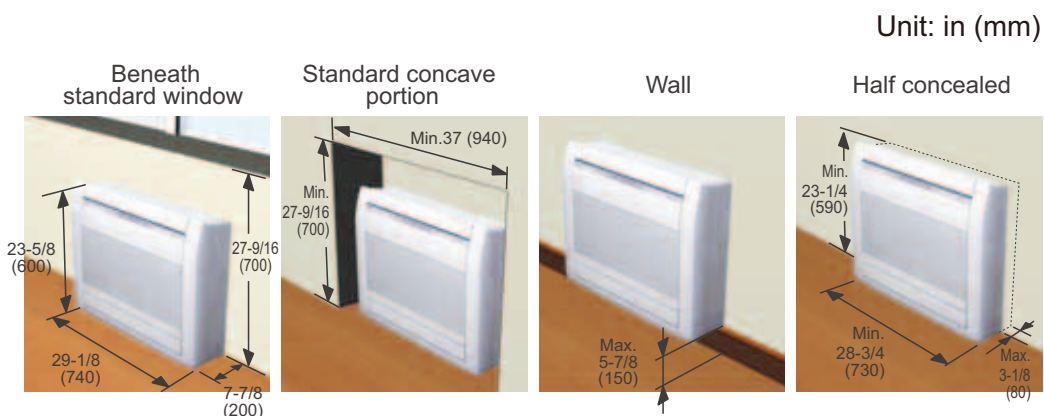

- Filter features



Ion deodorization filter

The filter deodorizes by powerfully decomposing absorbed odors using the oxidizing and reducing effects of ions generated by the ultra-fine-particle ceramic.



Using different filters at both sides



Apple-catechin filter

Apple-catechin filter uses static electricity to clean fine particles and dust in the air.

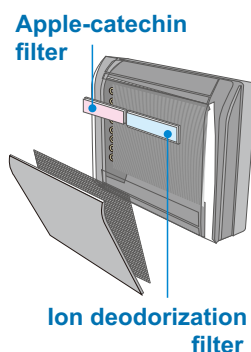

- **Easy maintenance**
Removable and washable panel

Removable panel

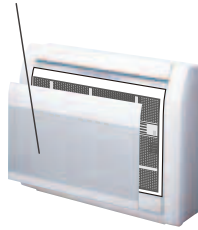

- **Flexible piping connection**
6 directions of drain and piping

Back view

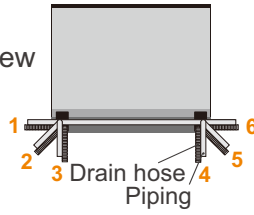

1-3. Control system design

■ Advanced integrated control system

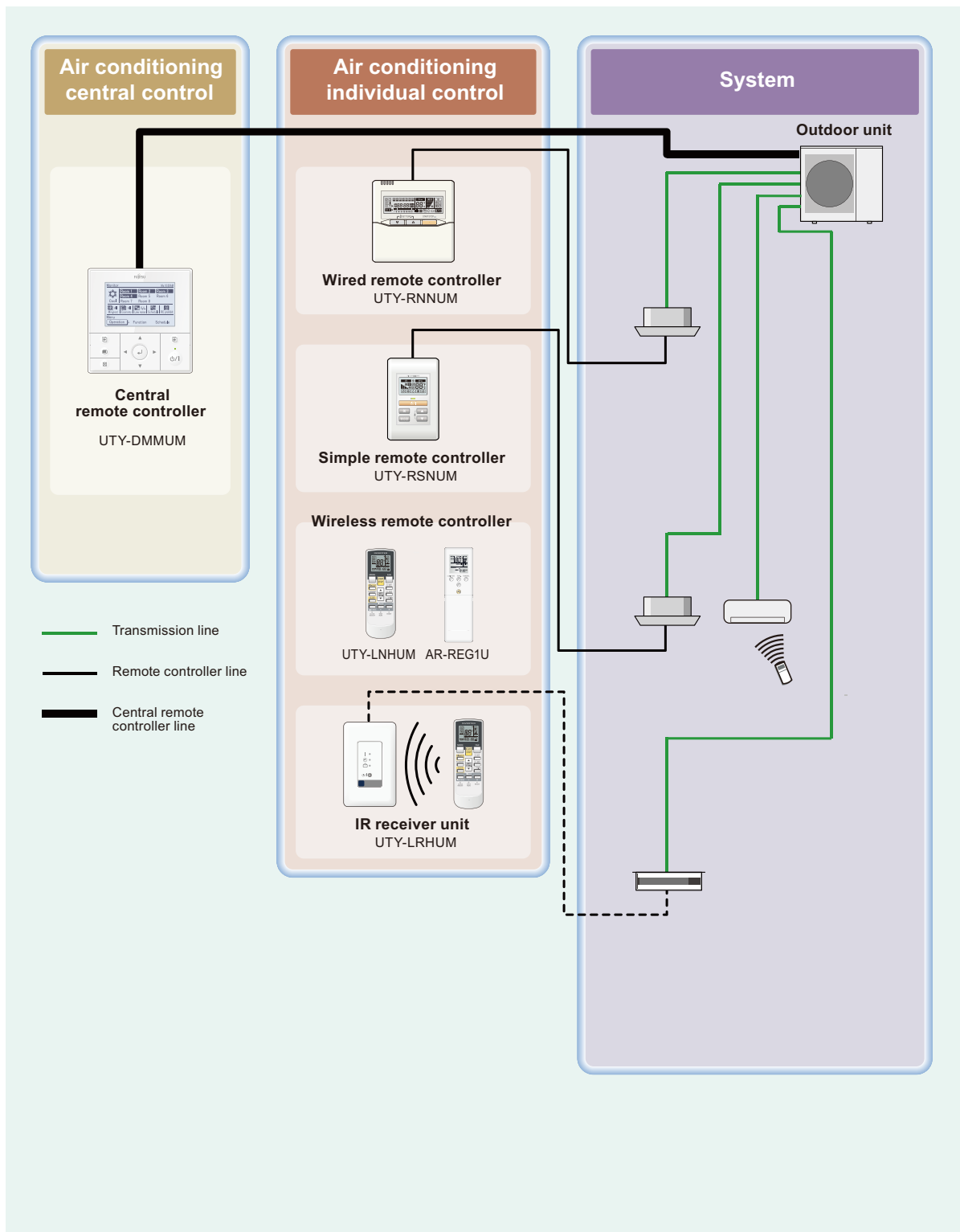

1-4. Outdoor unit

■ Simple system from installation to management

New system can decrease other unit than previous system.
And total management can be done by only one optional controller.

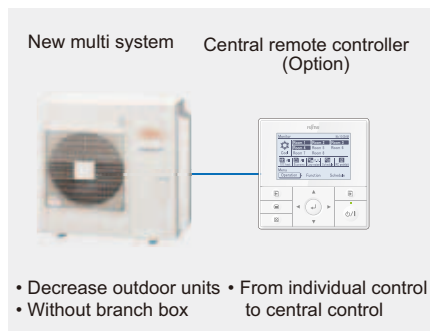

■ Compact chassis and High SEER / HSPF

High SEER/HSPF is realized by adopting the efficient DC rotary compressor and inverter technology with compact chassis.

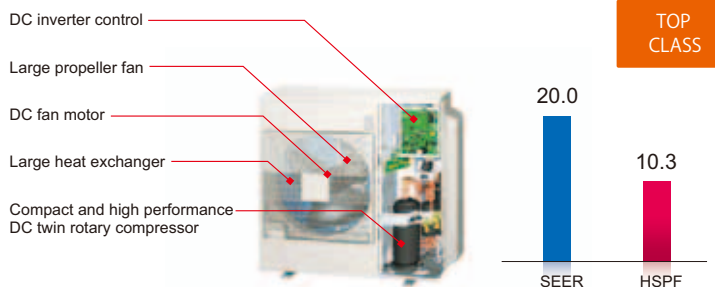

■ Easy installation

By using centralized valve method, new outdoor unit can be done vacuuming and opening valve only one time.

Previous multi system



- Required vacuuming up to 4* times
- *: In the case of 4 rooms multi system.

New multi system

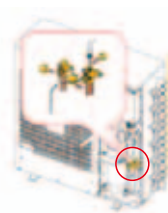

- Required vacuuming only one time

Automatic wiring and piping check

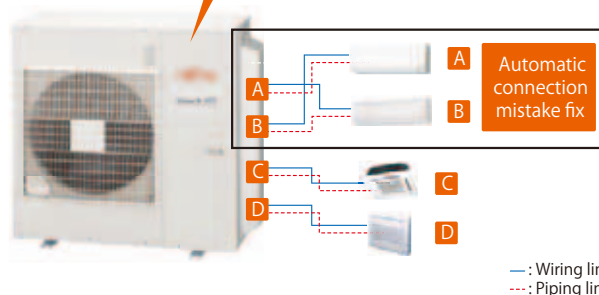

■ Workable down to -15 °F (-26 °C) outdoor temperature

Outdoor unit has a built-in heater to keep it from freezing during the freezing cold mid-winter season.

The air conditioner uses highly cold resistant components that were designed to prevent freezing and meet CSA standards to provide comfortable heating even when temperature fall to -15 °F (-26 °C).

Base pan heater (Built-in)

- Equipped with a base heater that prevents condensate from freezing.
- Cultivated base design discharges melted water through many holes.
- Without a heater, freezing condensate can cause noise, damage to blade, condenser, and system performance.



Base heater



2. Remote controller

2-1. Wireless remote controller (UTY-LNHUM)

■ Features



- 4 kinds of timer setup (on/off/program/sleep) are possible.
- Can be used jointly with wired remote controllers.
- Easy to change custom code (max. 4 custom codes) by button operation.

● Program timer

The program timer operates the on and off timer once within a 24-hour period.

● Sleep timer

The sleep timer function automatically corrects the temperature thermostat setting according to the time setting to prevent excessive cooling and heating while sleeping.

Cooling operation/Dry operation

When the sleep timer is set, the set temperature automatically rises 2 °F (1 °C) every hour. The set temperature can rise up to a maximum of 4 °F (2 °C).

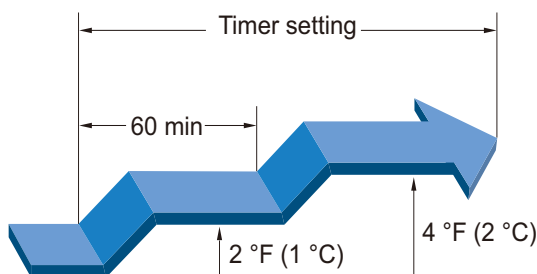

Heating operation

When the sleep timer is set, the set temperature automatically drops 2 °F (1 °C) every 30 minutes. The set temperature can drop to a maximum of 8 °F (4 °C).

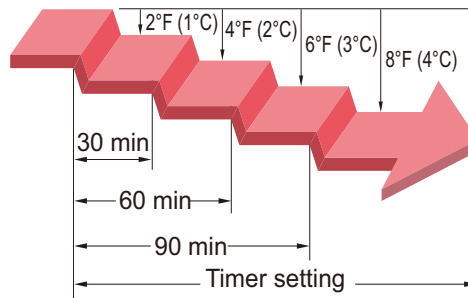

● Simple function setting

Setting of the air conditioner selection function is performed by remote controller.

● Switching remote controller custom code

Code selector switch eliminates unit being wrongly switched. (Up to 4 codes can be set.)

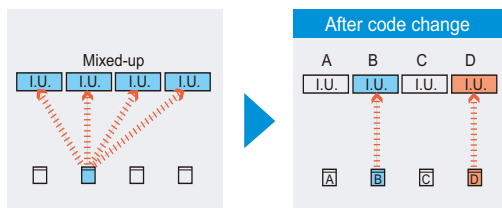

* I.U.: Indoor unit

Overview

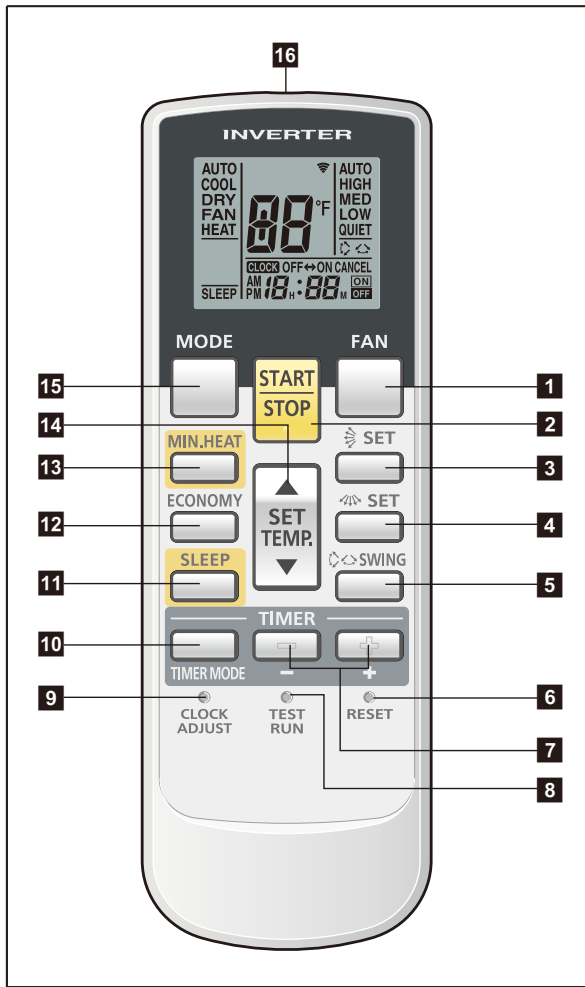

Display panel

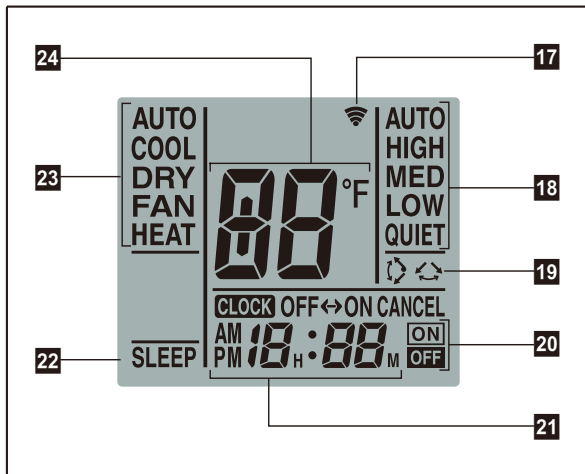

- 1 FAN button**
Selects the fan speed (AUTO, HIGH, MED, LOW, and QUIET).
- 2 START/STOP button**
Starts and stops operation.
- 3 SET button (vertical)**
Adjusts the vertical airflow direction.
- 4 SET button (horizontal)**
Adjusts the horizontal airflow direction.
- 5 SWING button**
Sets the automatic swing operation and selects swing mode (Up/down, Left/right, Up/down/left/right, and Stop swing).
- 6 RESET button**
Used when replacing batteries.
- 7 Timer set (- / +) button**
Sets the current time and on-off time.
- 8 TEST RUN button**
Only used for the initial test in the unit installation.
- 9 CLOCK ADJUST button**
Used for adjusting the clock.
- 10 TIMER MODE button**
Selects the timer mode (off timer, on timer, program timer, and timer reset).
- 11 SLEEP button**
Pressed to select sleep timer.
- 12 ECONOMY button**
- 13 MIN. HEAT button**
- 14 SET TEMP. (temperature) (▲ / ▼) button**
 - Sets desired temperature.
 - Sets remote controller custom code.
- 15 MODE button**
 - Switches operation mode (AUTO, COOL, DRY, FAN, and HEAT).
 - Starts/ends the remote controller custom code (max. 4 types) change.
- 16 Signal transmitter**
- 17 Signal transmit indicator**
- 18 Fan speed indicator**
- 19 Swing indicator**
- 20 Timer mode indicator**
- 21 Clock indicator**
- 22 Sleep indicator**
- 23 Operating mode indicator**
- 24 Temperature indicator**

NOTE: Functions may differ by type of the indoor unit.
For details, refer to the operation manual.

Specifications

● Controller

Unit: in (mm)

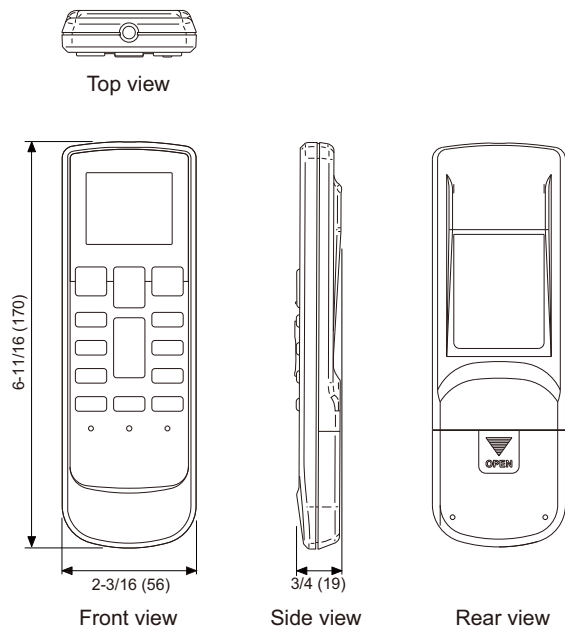

Size (H × W × D)	in (mm)	$6\frac{11}{16} \times 2\frac{3}{16} \times \frac{3}{4}$ (170 × 56 × 19)
Weight	oz (g)	3 (85) (without batteries)

● Holder

Unit: in (mm)

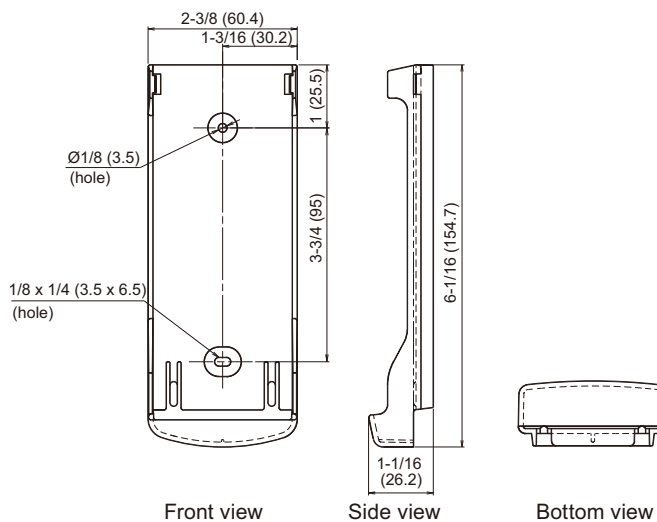

Size (H × W × D)	in (mm)	$6\frac{1}{16} \times 2\frac{3}{8} \times 1\frac{1}{16}$ (154.7 × 60.4 × 26.2)
Weight	oz (g)	10 (28)

2-2. Wireless remote controller (AR-REG1U)

■ Features

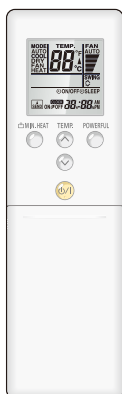

- 4-mode timer setup (on, off, program, and sleep) available.
- Easy operation.
- Easy to change custom code (max. 4 custom code).
- Can be used jointly with wired remote controllers.

● Simple function setting

Setting of the air conditioner selection function is performed by remote controller.

● Program timer

The program timer operates the on and off timer once within a 24-hour period.

● Sleep timer

The sleep timer function automatically corrects the temperature thermostat setting according to the time setting to prevent excessive cooling and heating while sleeping.

Cooling operation/Dry operation

When the sleep timer is set, the set temperature automatically rises 2 °F (1 °C) every hour. The set temperature can rise up to a maximum of 4 °F (2 °C).

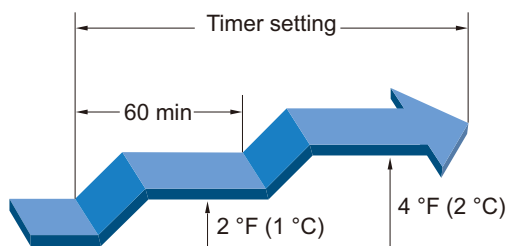

Heating operation

When the sleep timer is set, the set temperature automatically drops 2 °F (1 °C) every 30 minutes. The set temperature can drop to a maximum of 8 °F (4 °C).

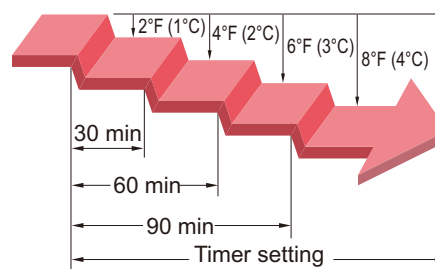

● Switching remote controller custom code

Code selector switch eliminates unit being wrongly switched. (Up to 4 codes can be set.)

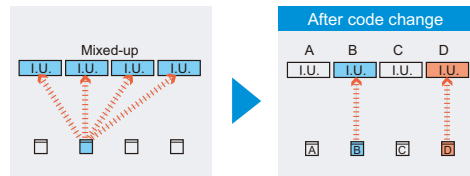

* I.U.: Indoor unit

● Temperature unit switchable

Easy to change the temperature unit between °F and °C by button operation.

Overview

AR-REG1U

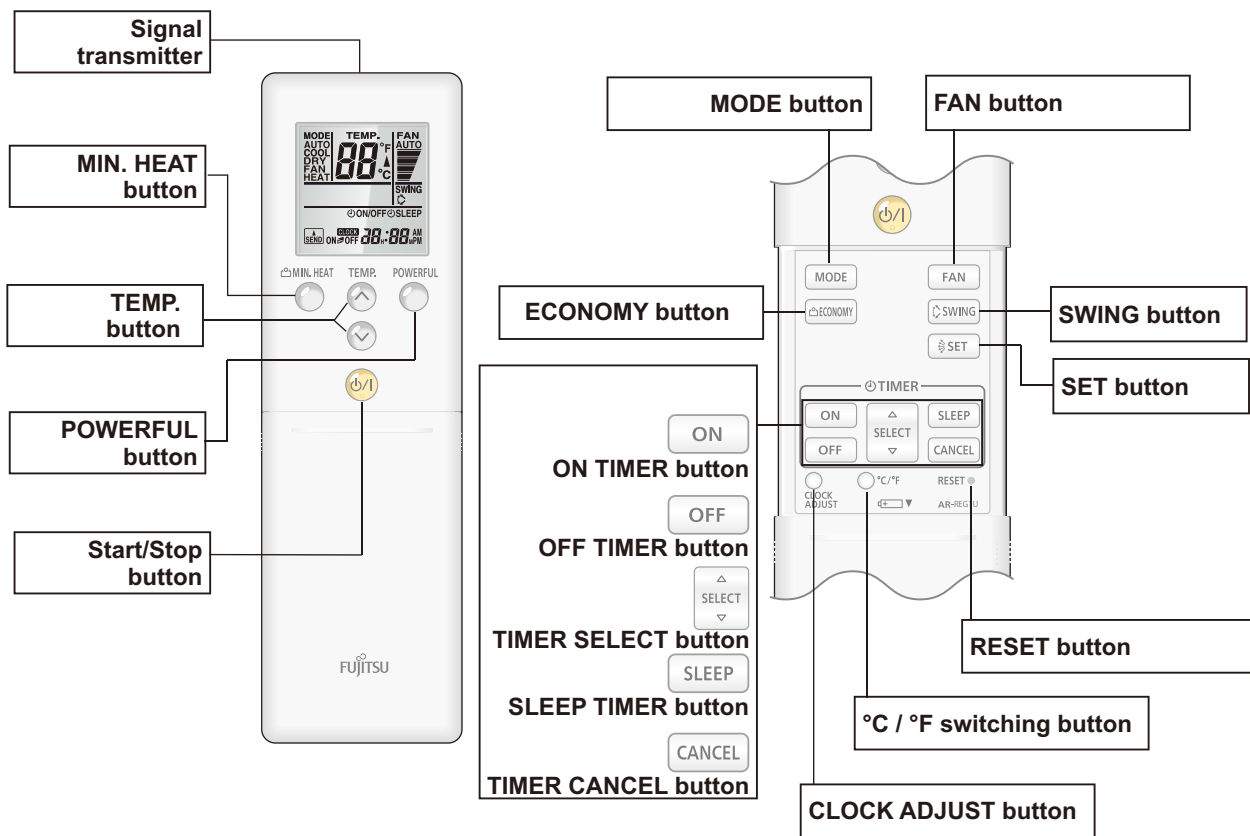

NOTE: Functions may differ by type of the indoor unit. For details, refer to the operation manual.

Display panel

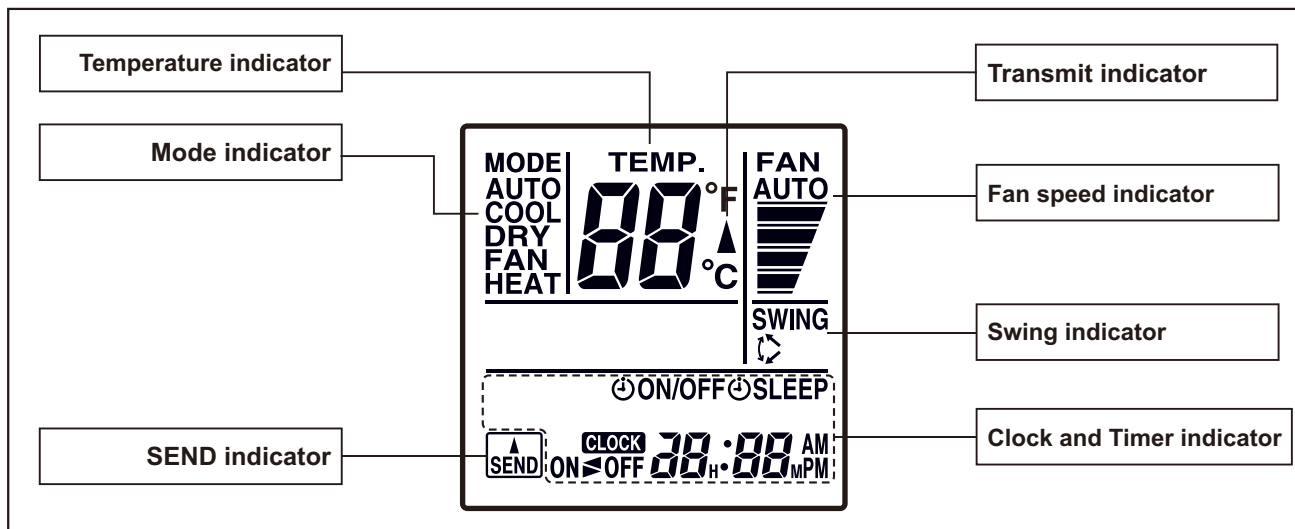

To facilitate explanation, the accompanying illustration has been drawn to show all possible indicators; in actual operation, however, the display will only show those indicators appropriate to the current operation.

■ Specifications

● Controller

Unit: in (mm)

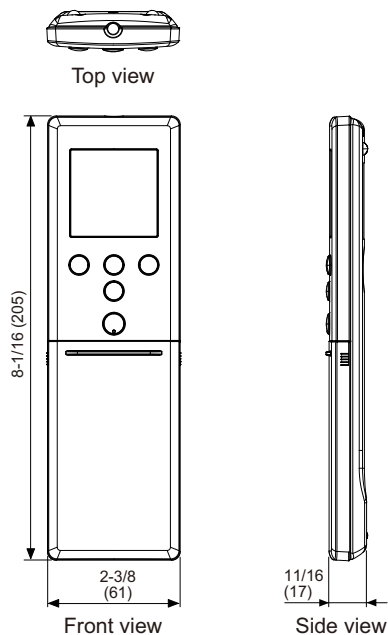

Size (H × W × D)	in (mm)	8-1/16 × 2-3/8 × 11/16 (205 × 61 × 17)
Weight	oz (g)	4.3 (122) (without batteries)

● Holder

Unit: in (mm)

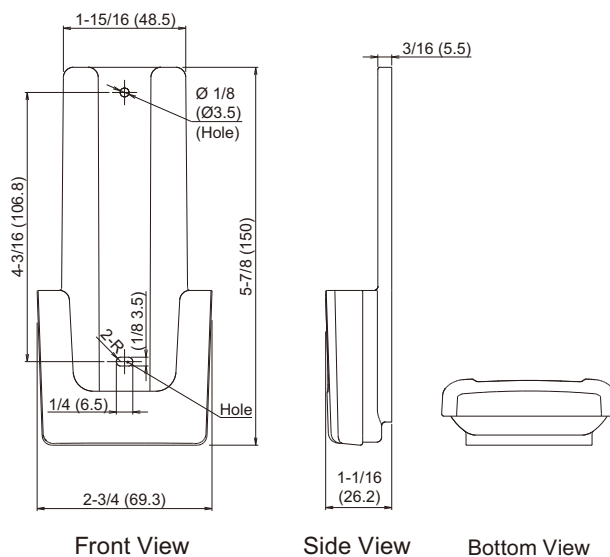

Size (H × W × D)	in (mm)	5-7/8 × 2-3/4 × 1-1/16 (150 × 69.3 × 26.2)
Weight	oz (g)	1 (27)

2-3. Wired remote controller (UTY-RNNUM)

■ Features

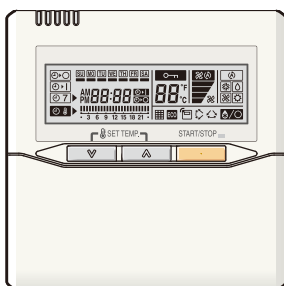

- Various timer setup available (on, off, and weekly).
- Equipped with weekly timer as standard function. (Start/stop function is twice per day for a week.)
- When setting up the timer, operation mode and temperature setup can be changed.
- When a failure occurs, the error code is displayed.
- Error history. (Last 16 error codes can be accessed.)
- The room temperature can be controlled by detecting the temperature accurately with built-in thermo sensor.

● High performance and compact size



● Accurate and comfortable

Indoor temperature can be detected accurately by the inclusion of a thermo sensor in the body of the wired controller.

Our system can correspond to various scenes.

This wired remote controller and the optional remote sensor allows flexibility in sensor location, and suitable for all requirements.

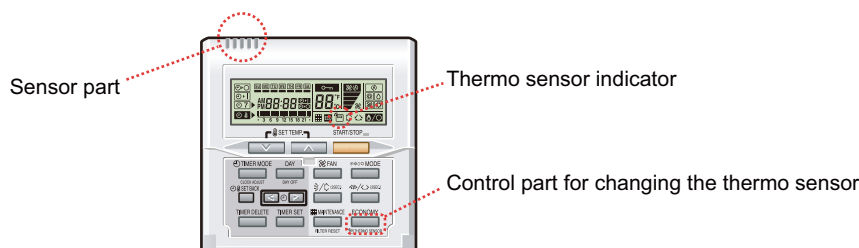

● Built-in timers

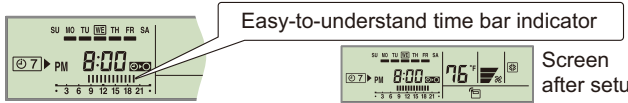
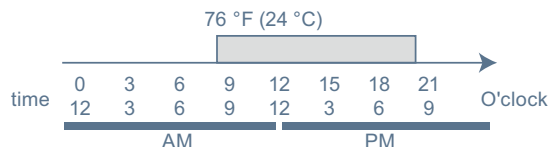
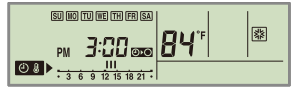
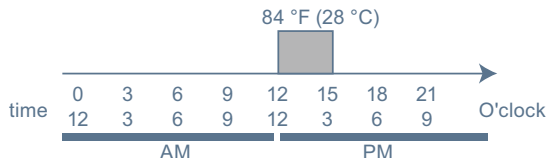
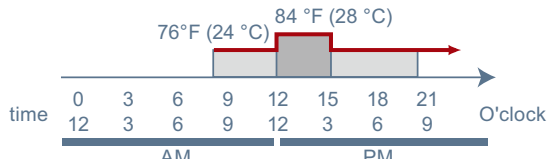
Weekly timer	Setback timer
Possible to set on/off time to operate twice each day of the week.	Possible to set temperature for two time spans and for each day of the week.
 <p>Example: (Set to Wednesday: 8:00 to 20:00)</p> 	 <p>Example: setup screen (Set from Sunday to Saturday: 12:00 to 15:00, 28 °C.)</p> 
At "Weekly timer" + "Set back timer" setup	
<div style="border: 1px solid red; padding: 5px; display: inline-block; margin: 10px;"> <p>76 °F → 84 °F → 76 °F 24 °C → 28 °C → 24 °C</p> </div> 	

● Easy-to-understand operation

[Variable timer control]

The operation/display sections are zoned according to time and operation, enabling variable programming to match application.

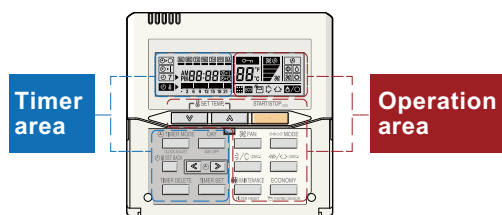

● Simple installation

Components are compatible with standard switch boxes. Flat-back surface allows equipment to be installed wherever it is needed.

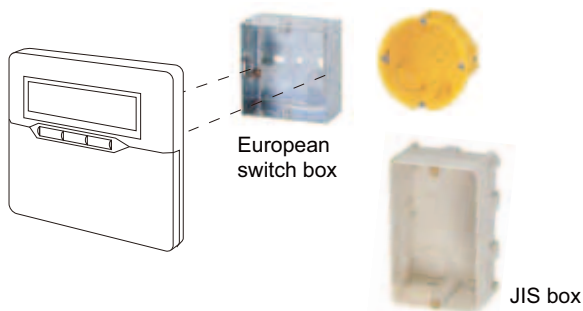

● System diagram

1 remote controller

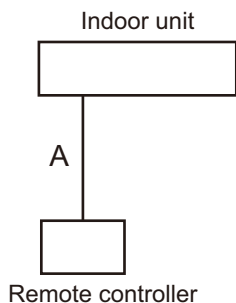

2 remote controllers

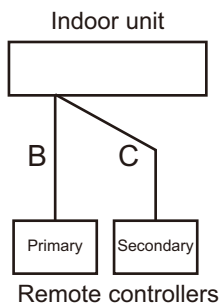

A, B, C: Remote controller cable
 $A \leq 1,640 \text{ ft (500 m)}$; $B + C \leq 1,640 \text{ ft (500 m)}$

● Electrical wiring

1 remote controller

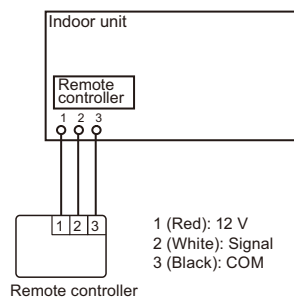

1 (Red): 12 V
 2 (White): Signal
 3 (Black): COM

2 remote controllers

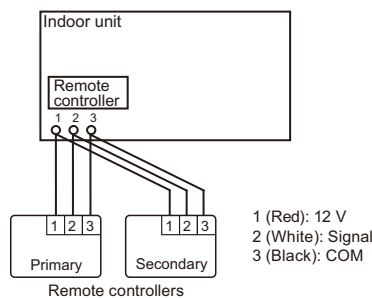



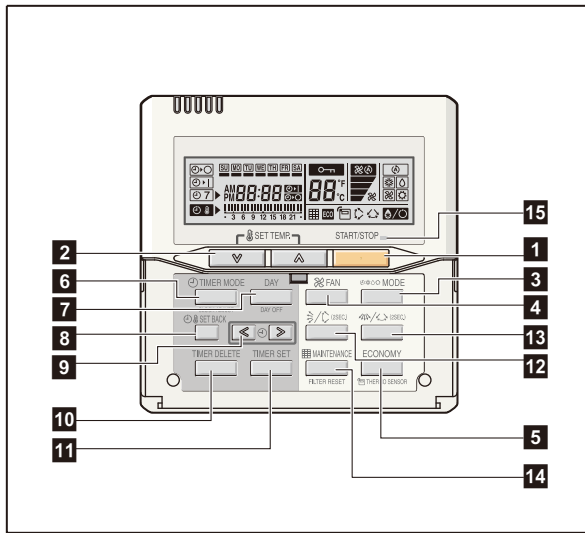

1 (Red): 12 V
 2 (White): Signal
 3 (Black): COM

Overview

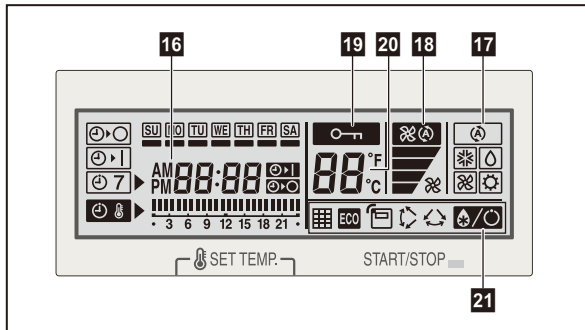

Display panel



- 1 START/STOP button**
Starts and stops operation.
- 2 SET TEMP. button**
Selects the setting temperature.
- 3 MODE button**
Selects the operating mode (AUTO , HEAT , FAN , COOL , and DRY ).
- 4 FAN button**
Selects the fan speed AUTO , QUIET , LOW , MED , and HIGH .
- 5 ECONOMY (THERMO SENSOR) button**
Turns the economy-efficient mode on and off.
- 6 TIMER MODE (CLOCK ADJUST) button**
Selects the timer mode (off timer, on timer, and weekly timer). Sets the current time.
- 7 DAY (DAY OFF) button**
Temporarily cancels one day timer.
- 8 SET BACK button**
Selects the set back timer.
- 9 Set time button**
Pressed to set time.
- 10 TIMER DELETE button**
Deletes the weekly timer schedule.
- 11 TIMER SET button**
Sets the date, hour, minute, and on-off time.
- 12 Vertical airflow direction and swing button**
Push for 2 seconds to change the swing mode.
- 13 Horizontal airflow direction and swing button**
Push for 2 seconds to change the swing mode.
- 14 FILTER RESET button**
- 15 Operation lamp**
Lights during operation and when the timer is on.
- 16 Timer and clock indicator**
- 17 Operation mode indicator**
- 18 Fan speed indicator**
- 19 Operation lock indicator**
- 20 Temperature indicator**
- 21 Function indicators**
 -  Defrost indicator
 -  Thermo sensor indicator
 -  Economy indicator
 -  Vertical swing indicator
 -  Horizontal swing indicator
 -  Filter indicator

NOTE: Functions may differ by type of the indoor unit.
For details, refer to the operation manual.

Specifications

Dimensions and other specifications on the wired remote controller are as follows.

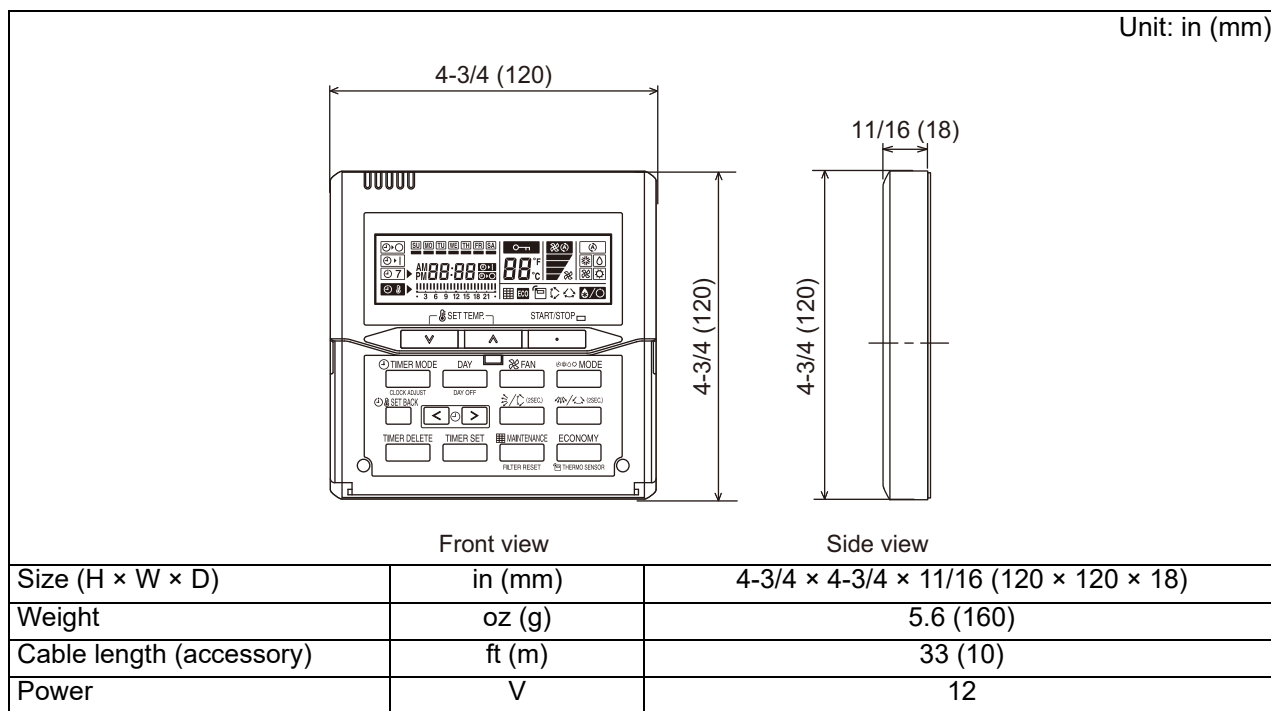

■ Installation

● Connection pattern

NOTE: Connection pattern is different according to type of Indoor unit.

Indoor unit types		Connection pattern
Compact cassette type		Pattern A
Slim duct type		
Wall mounted type	ASU7RLF1, ASU9RLF1, ASU12RLF1, and ASU15RLF1	Pattern B
	ASU18RLF and ASU24RLF	Pattern C
Floor type		

● Pattern A

Connect the end of remote controller cable directly to the exclusive terminal block.

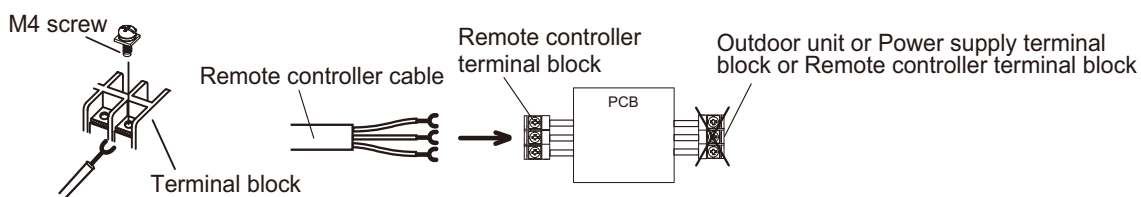

NOTE: It may be failed if it is connected to the outdoor unit or the terminal block for power supply.

● Pattern B

1. Modify the remote controller cable as follows:

- Use a tool to cut off the terminal on the end of the remote controller cable and then remove the insulation from the cut end of the cable as shown in following figure.
- Connect the remote controller cable and connecting cable as shown in following figure.
- Be sure to insulate the connection between the cables.

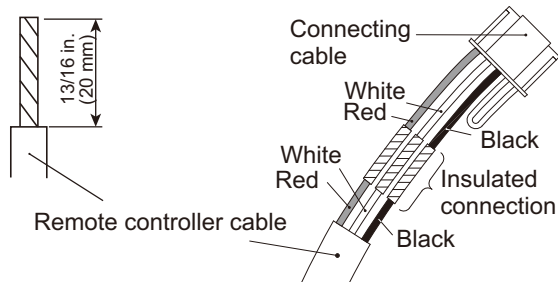

2. Connect the remote controller cable.

- Connect the cable made in step 1. to the terminal (*1) of optional communication kit.
- Connect the cable from the terminal (*2) of communication kit to the indoor unit PCB.

*1: CNC01 (for ASU7/9/12/15RLF1: UTY-XCBXZ2)

*2: CND01 (for ASU7/9/12/15RLF1: UTY-XCBXZ2)

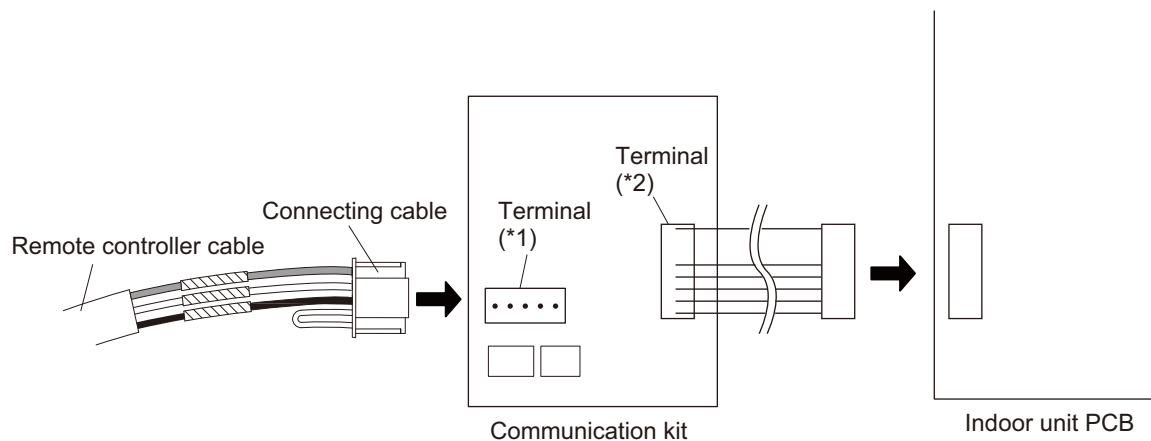

● Pattern C

1. Modify the remote controller cable as follows:

- Use a tool to cut off the terminal on the end of the remote controller cable and then remove the insulation from the cut end of the cable as shown in following figure.
- Connect the remote controller cable and connecting cable as shown in following figure.
- Be sure to insulate the connection between the cables.

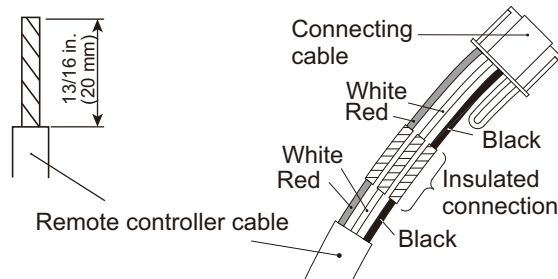

2. Connect the remote controller cable.

- Connect the cable made in step 1. to the indoor unit PCB.

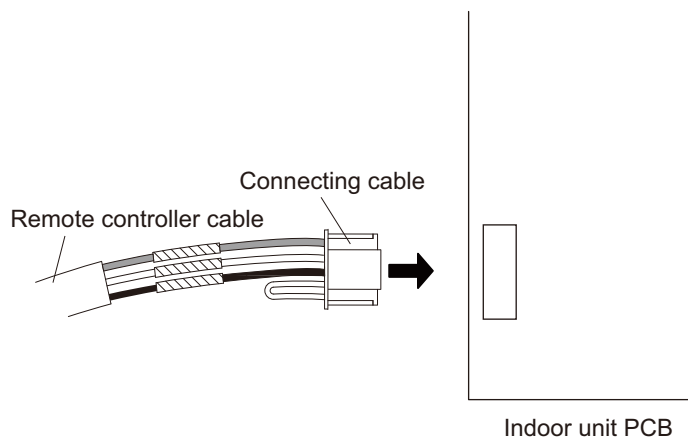

■ Wiring specifications

Use	Cable size	Wire type	Remarks
Remote controller cable	22AWG (0.33 mm ²)	Polar 3 core	Use sheathed PVC cable.

■ Optional parts

Wall mounted	Model name
ASU7/9/12/15RLF1	UTY-XCBXZ2

The communication kit is needed for connecting the wired remote controller to the compact wall mounted type.

2-4. Simple remote controller (UTY-RSNUM)

■ Features

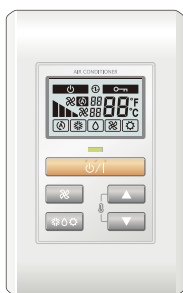

- Easy operation.
- Built-in backlight function.
- Easy installation with a slim shape with no bulge in the back.
- Error history. (Last 16 error codes can be accessed.)
- Can be installed onto switch box. (applies to European and other country's standard)

● Easy-to-understand operation

- Provides access to basic operations, such as start/stop, fan speed, operation mode and room temperature setting.
- A large start/stop button is provided in the center of the remote controller unit for easy operation.
- Following an error display, diagnostics can be carried out on the controller.

● LCD backlight

- LCD backlight enables easy operation in a dark room.
- Backlight activates during all button operations, and lasts 10 seconds in operating mode and 5 seconds in stop mode after a button is pressed.



● Simple installation

Can be mounted on the European switch box (installation dimension: 2-3/8 in [60 mm]) or the JIS built-in box (installation dimension: 3-5/16 in [83.5 mm]).

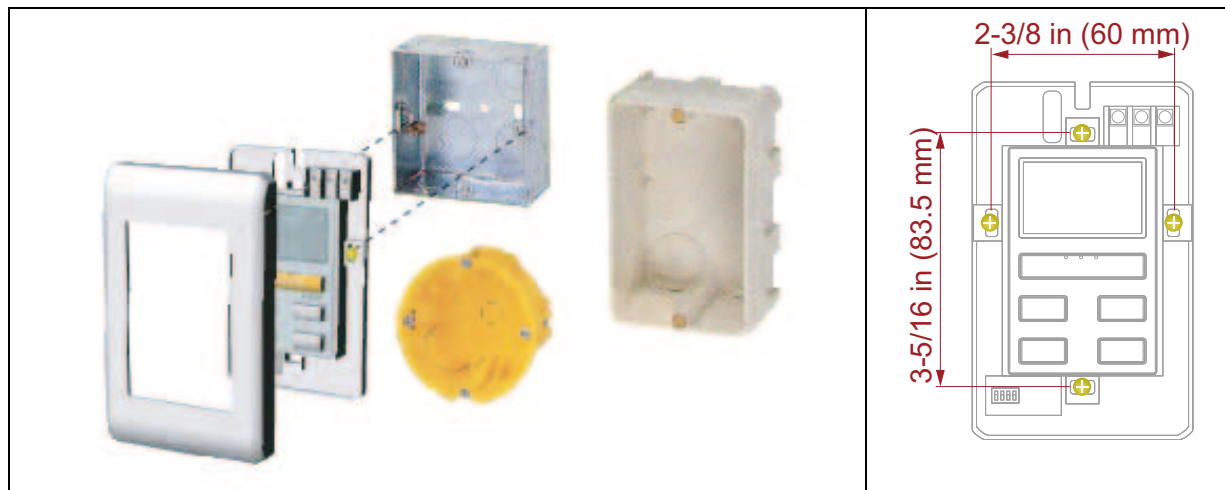

● System diagram

1 remote controller

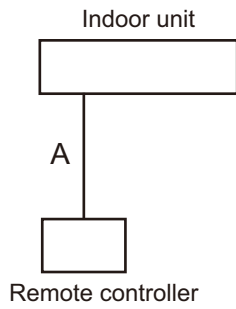

2 remote controllers

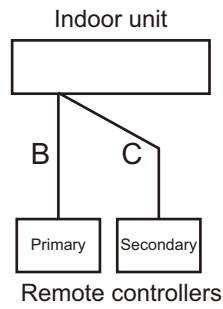

A, B, C: Remote controller cable
 $A \leq 1,640 \text{ ft (500 m)}$; $B+C \leq 1,640 \text{ ft (500 m)}$

● Electrical wiring

1 remote controller

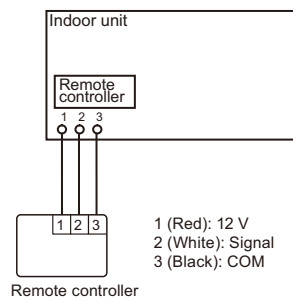

2 remote controllers

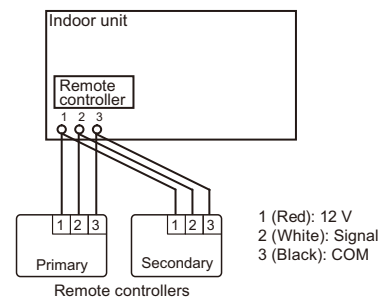



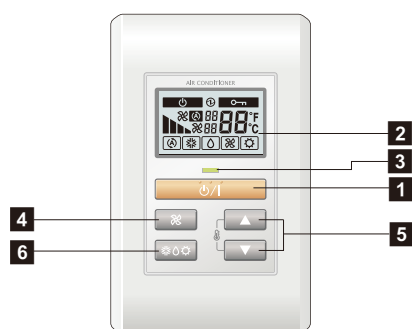



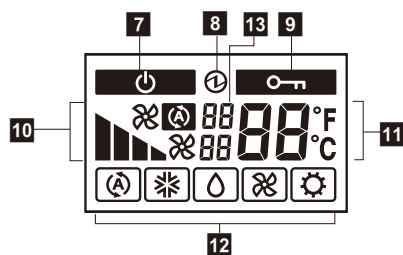



Overview



Display panel



- 1 START/STOP button**
Starts and stops operation.
- 2 Display backlight button**
Lights during operation.
- 3 Operation lamp**
Lights during operation.
- 4 FAN button**
Selects the fan speed (AUTO , HIGH , MED , LOW , and QUIET ).
- 5 SET TEMP. button**
Selects the setting temperature.
- 6 MODE button**
Selects the operating mode (AUTO , COOL , DRY , FAN , HEAT ).
- 7 Standby indicator**
Indicates during the oil recovery and defrosting operation.
- 8 Power source indicator**
Indicates the main power is on.
- 9 Central control indicator**
Indicates when function is locked.
- 10 Fan speed indicator**
Deletes the weekly timer schedule.
- 11 Set temperature**
 - Indicates error history number in error code history display mode.
 - Indicates indoor unit address in address display mode.
- 12 Operating mode indicator**
- 13 Indicator**
 - Upper:
 - Indicates the error code in error code history display mode and in self diagnosis mode.
 - Indicates the refrigerant system address in address display mode.
 - Lower: Indicates the remote controller address in error code history display mode, address display mode, and self diagnosis mode.

■ Specifications

Dimensions and other specifications on the wired remote controller are as follows.

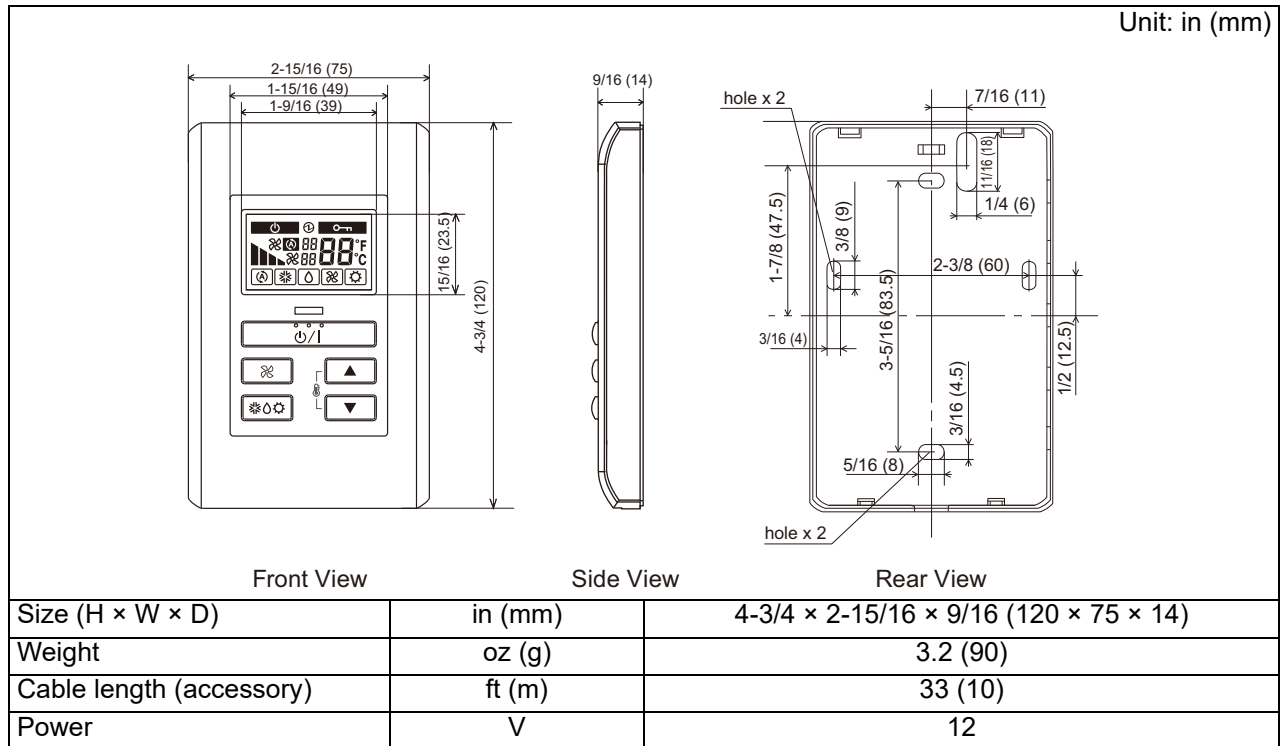

■ Installation

● Connection pattern

NOTE: Connection pattern is different according to type of Indoor unit.

Indoor unit types		Connection pattern
Compact cassette type		Pattern A
Slim duct type		
Wall mounted type	ASU7RLF1, ASU9RLF1, ASU12RLF1, and ASU15RLF1	Pattern B
	ASU18RLF and ASU24RLF	Pattern C
Floor type		

● Pattern A

Connect the end of remote controller cable directly to the exclusive terminal block.

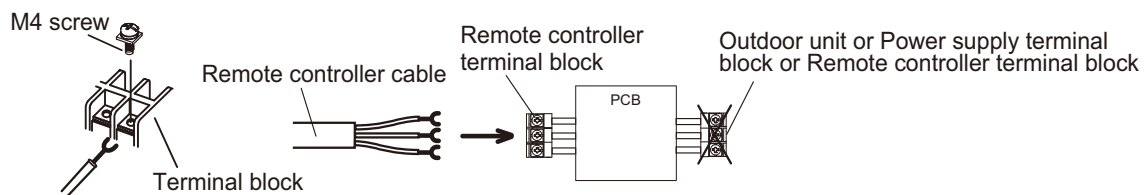

NOTE: It may be failed if it is connected to the outdoor unit or the terminal block for power supply.

● Pattern B

1. Modify the remote controller cable as follows:

- Use a tool to cut off the terminal on the end of the remote controller cable and then remove the insulation from the cut end of the cable as shown in following figure.
- Connect the remote controller cable and connecting cable as shown in following figure.
- Be sure to insulate the connection between the cables.

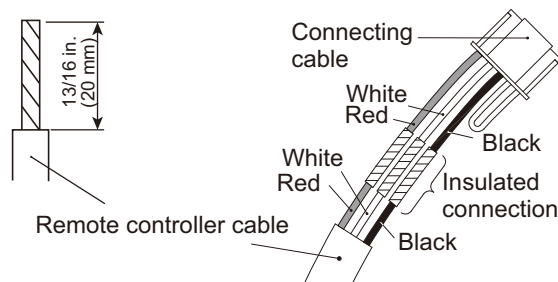

2. Connect the remote controller cable.

- Connect the cable made in step 1. to the terminal (*1) of optional communication kit.
- Connect the cable from the terminal (*2) of communication kit to the indoor unit PCB.

*1: CNC01 (for ASU7/9/12/15RLF1: UTY-XCBXZ2)

*2: CND01 (for ASU7/9/12/15RLF1: UTY-XCBXZ2)

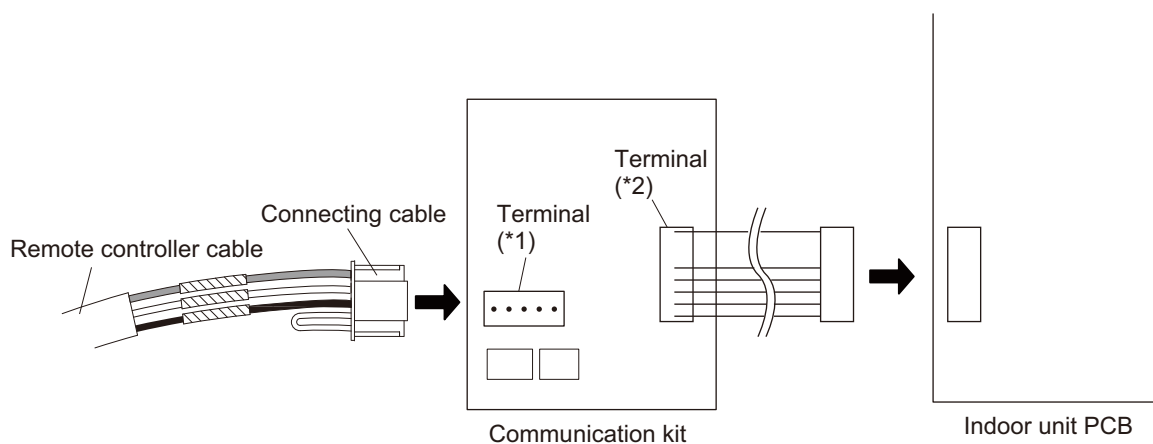

● Pattern C

1. Modify the remote controller cable as follows:

- Use a tool to cut off the terminal on the end of the remote controller cable and then remove the insulation from the cut end of the cable as shown in following figure.
- Connect the remote controller cable and connecting cable as shown in following figure.
- Be sure to insulate the connection between the cables.

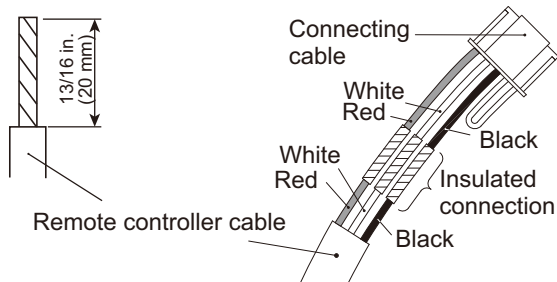

2. Connect the remote controller cable.

- Connect the cable made in step 1. to the indoor unit PCB.

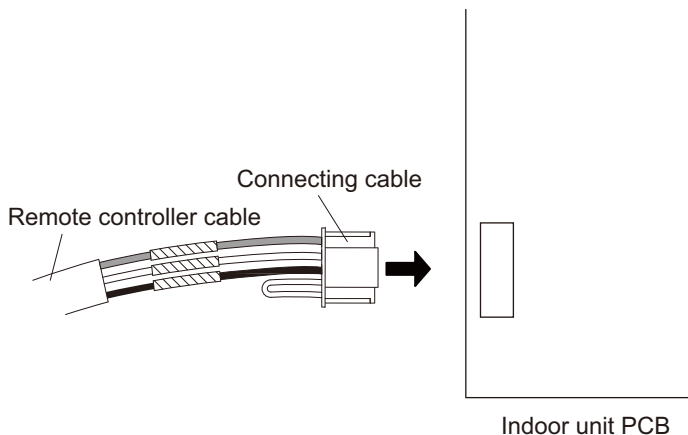

■ Wiring specifications

Use	Cable size	Wire type	Remarks
Remote controller cable	22AWG (0.33 mm ²)	Polar 3 core	Use sheathed PVC cable.

■ Optional parts

Wall mounted	Model name
ASU7/9/12/15RLF1	UTY-XCBXZ2

The communication kit is needed for connecting the wired remote controller to the compact wall mounted type.

2-5. Central remote controller (UTY-DMMUM)

■ Features

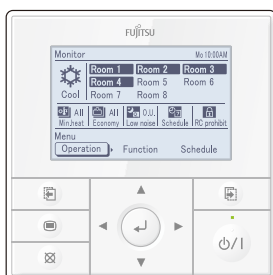

- Large and full-dot liquid crystal screen.
- The backlit LCD enables easy operation in a dark room.
- Wide and large keys easy to press, user-intuitive arrow key.

● Central and individual control

The temperature, airflow volume, and remote control prohibition settings of all indoor units can be batched.

● Easy-to-understand operation

- Large backlit LCD.
- Large easy-to-see operation panel.

● Easy installation

- Central remote controller is connected directly to the indoor unit, making the installation process easier.
- Once the controller is connected, it can automatic register and display all the indoor units.

● Outdoor unit low noise operation

Users can choose from 2 low noise levels, depending on the installation environment.

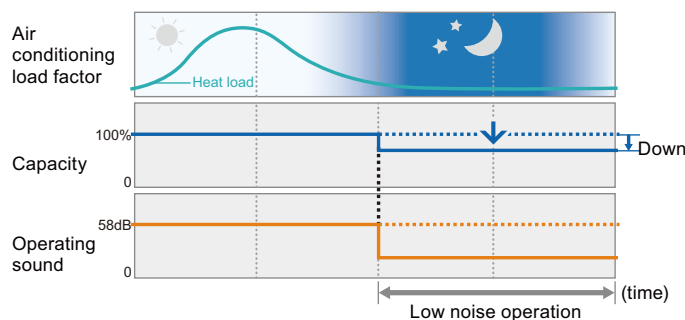

● Minimum heat (All) operation

While this function is selected, all indoor units start the minimum heat operation when all the indoor units are stopped by operation of the [On/Off button].

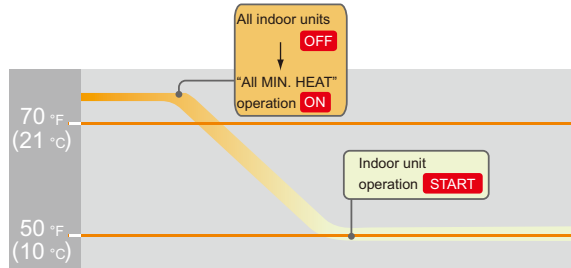

- When the room temperature is higher than 50 °F (10 °C), MIN. HEAT operation dose not start. Operation starts and maintains the room temperature at 50 °F (10 °C) when the temperature drops below 50 °F (10 °C).
- When "MIN, HEAT" operation stops, the room set temperature quickly returns to the preset temperature.

● Economy (All) operation

- If all the indoor and outdoor units are changed to economy mode, this can save more energy than setting of each indoor unit individually.
- Economy operation is energy saving, as the set temperature of indoor unit is shifted by 2 °F (1 °C) and the maximum electric value of the outdoor unit is suppressed.

Example: Cooling operation

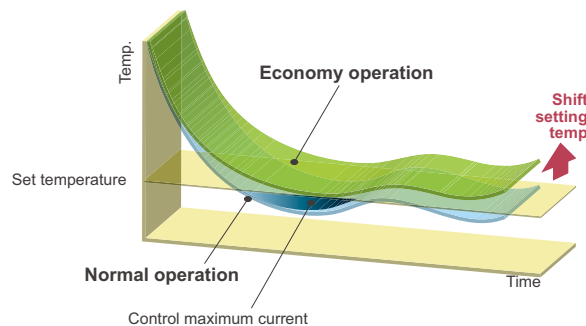

● Schedule timer

Operation setting can be changed 4 times in each day of a week, and 2 types of the schedule can be set to suit users' preference.

Example

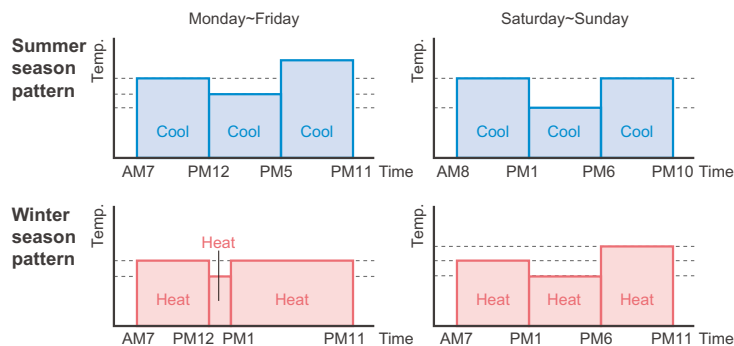

● Prohibited settings

The remote controller operation of all indoor units comes with a lock function to prevent unapproved operations in the various rooms. The central remote controller also has a key lock function to prevent children from playing with it, etc.

● Electrical wiring

Example: Wiring diagram when 3 indoor units are connected.

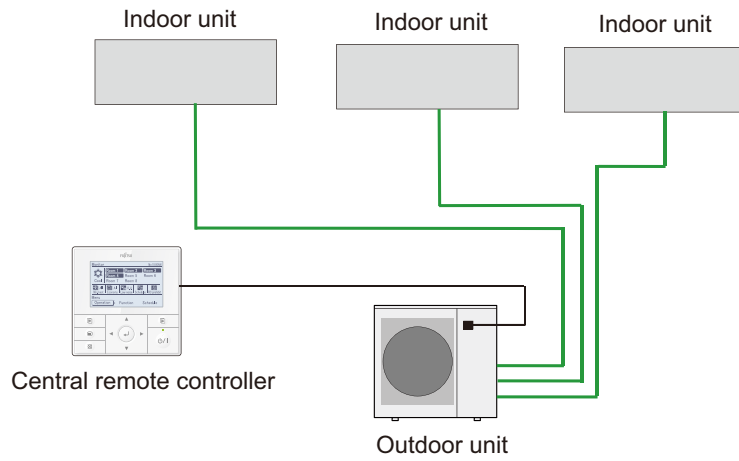

NOTE: Maximum length of remote controller cable is 1,650 ft (500 m).

Overview

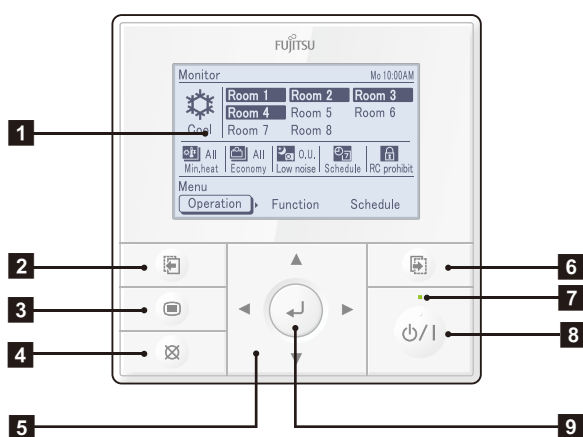

- 1 Display panel (with backlight)
- 2 Screen switch button (Left)
- 3 Menu button
- 4 Cancel button
- 5 Cursor button
- 6 Screen switch button (Right)
- 7 Power indicator
- 8 On / Off button
- 9 Enter button

Specifications

Dimensions and other specifications on the wired remote controller are as follows.

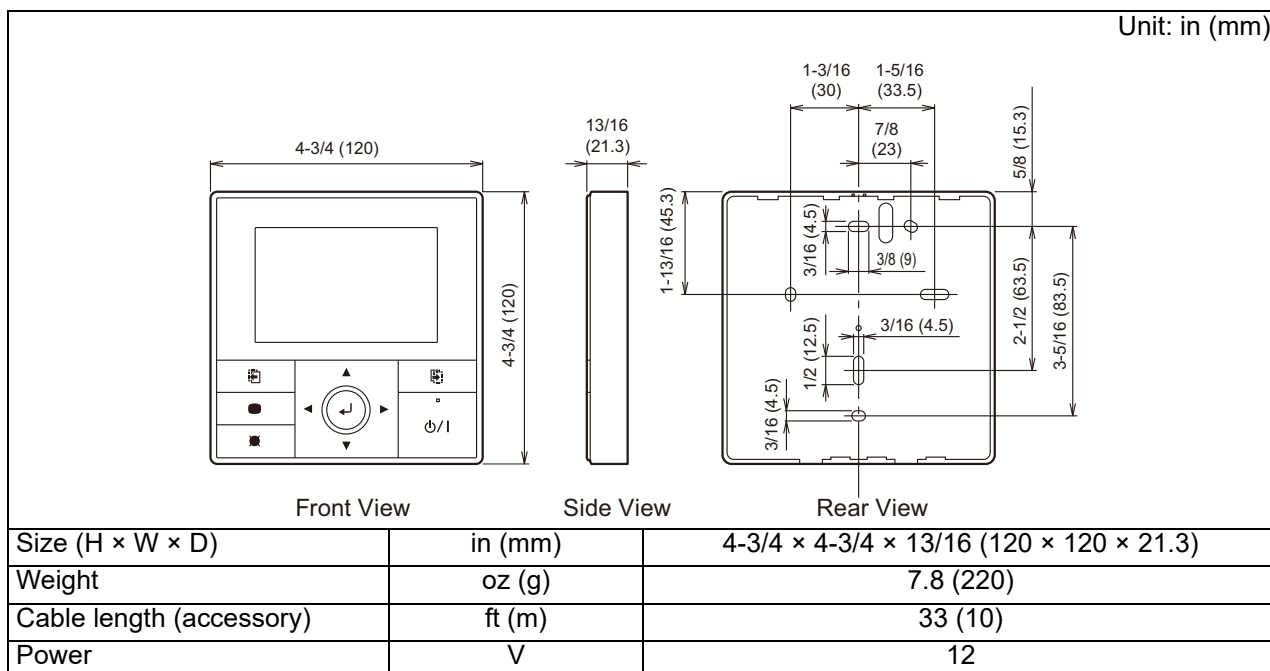

Wiring specifications

Use	Cable size	Wire type	Remarks
Remote controller cable	22AWG (0.33 mm ²)	Polar 3 core	Use sheathed PVC cable

Installation

1. Remove the insulation of the remote controller cable.

Unit: in (mm)

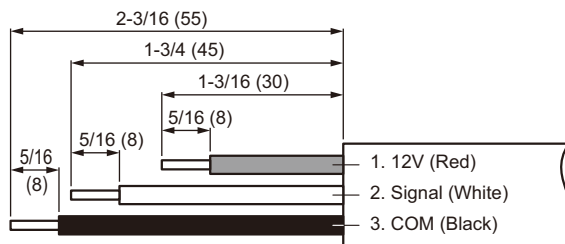

2. Insert the flat-blade screwdriver and remove the front case and rear case by twisting it slightly.

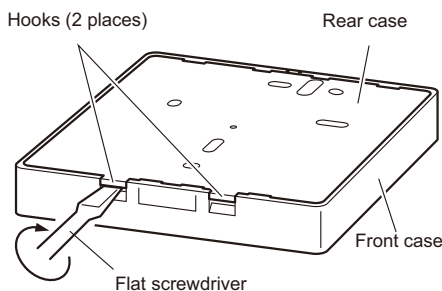

3. Install the rear case to the wall, box, etc. with 2 screws (M4 × 16 mm). Fix the 2 screws in either horizontal or vertical position.

A. When mounting on the box:

Attach the case after leading the cable.

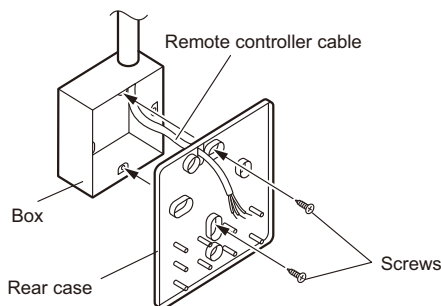

B. When the cable is along the wall:

- Mount the rear case on the wall.
- Remove knock out hole for cable routing in the front case.

CAUTION

When connecting the remote controller cable, take measures to prevent the water or insects coming into the remote controller through the cable, such as to provide the trap or close the hole for cabling with the putty.

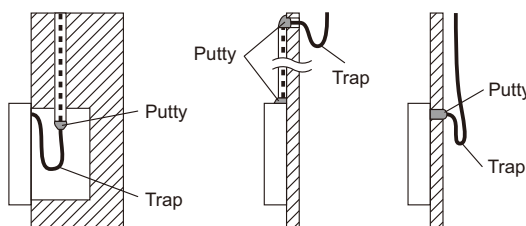

4. Configure the DIP switch setting with referring Chapter 13-8. "Central remote controller" on page 157.

5. Connect the cable to the terminals on the front case. Fix the cable together with the sheath by using the cable tie. Cut off the excess cable tie.

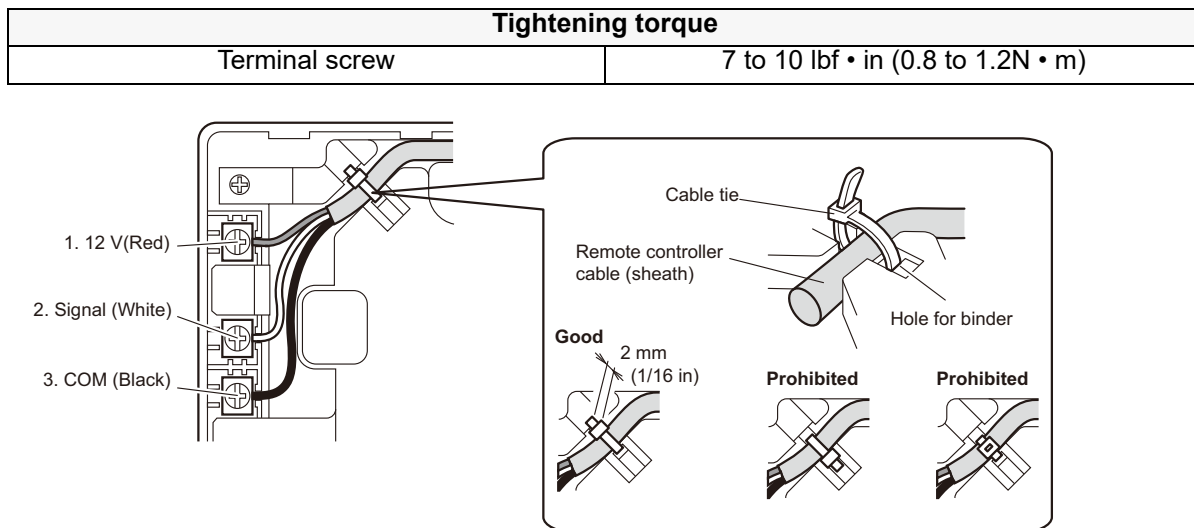

⚠ CAUTION

- Be careful to avoid breaking the cable by over-tightening the binder.
- When connecting the remote controller cables, do not over-tighten the screws.

6. Attach the front case.

- Adjust the upper part of the front case first, then insert the front case until it clicks.
- When inserting the front case, do not pinch the cable.

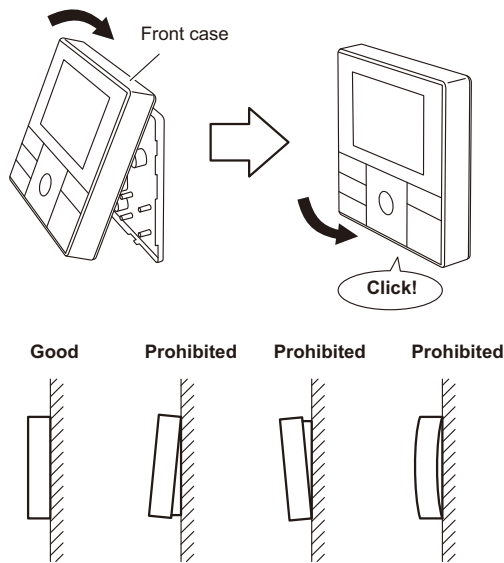

⚠ CAUTION

Insert the front case firmly. If improperly attached, it will cause the front case to fall off.

3. Specifications

3-1. Compact cassette type

Model name				AUU7RLF	AUU9RLF	AUU12RLF	AUU18RLF		
Power supply				208/230 V ~ 60 Hz					
Available voltage range				187—264 V					
Capacity			Btu/h class	7,000	9,000	12,000	18,000		
Input power			W	18	18	23	39		
Running current			A	0.15	0.15	0.19	0.30		
Fan	Airflow rate	Cooling	HIGH	CFM (m ³ /h)	318 (540)	318 (540)	359 (610)	441 (750)	
			MED		288 (490)	288 (490)	312 (530)	359 (610)	
			LOW		259 (440)	259 (440)	277 (470)	306(520)	
			QUIET		230 (390)	230 (390)	241 (410)	241 (410)	
		Heating	HIGH		318 (540)	318 (540)	359 (610)	471 (800)	
			MED		288 (490)	288 (490)	312 (530)	418 (710)	
			LOW		259 (440)	259 (440)	277 (470)	353 (600)	
			QUIET		230 (390)	230 (390)	241 (410)	265 (450)	
	Type × Q'ty		Turbo fan × 1						
	Motor output		W						
Sound pressure level *2				dB (A)	33	33	37	42	
Cooling		HIGH	31		31	33	37		
		MED	29		29	31	33		
		LOW	27		27	28	29		
		QUIET	34		34	37	44		
Heating		HIGH	32		32	33	40		
		MED	29		29	31	37		
		LOW	27		27	28	30		
		QUIET							
Heat exchanger type			Dimensions (H × W × D)	in (mm)	8-1/4 × 51-9/16 × 1/2 + 8-1/4 × 49-3/16 × 1/2 (210 × 1,310 × 13.3 + 210 × 1,250 × 13.3)				
			Fin pitch	FPI	21				
			Rows × Stages	2 × 10					
			Pipe type	Copper tube					
			Fin type	Aluminum					
Dimensions (H × W × D)		Net	in (mm)	9-5/8 × 22-7/16 × 22-7/16 (245 × 570 × 570)					
		Gross		10-7/16 × 28-3/4 × 24-5/8 (265 × 730 × 625)					
Weight		Net	lb (kg)	33 (15)					
		Gross		40 (18)					
Connection pipe		Size	Liquid	Ø1/4 (Ø6.35)					
			Gas	Ø3/8 (Ø9.52)			Ø1/2 (Ø12.70)		
		Method	Flare						
Operation range		Cooling	°F (°C)	64 to 90 (18 to 32)					
			%RH	80 or less					
		Heating	°F (°C)	60 to 88 (16 to 31)					
Drain hose		Material	Hard PVC						
		Size	in (mm)	Ø 3/4(I.D.), Ø 1-1/16(O.D.) [Ø 20.7 (I.D.), Ø 26.6 (O.D.)]					
Cassette grille			Model name		UTG-CCGF				
			Material		PS				
			Color		White (Approximate color of MUNSELL N 9.25 /)				
			Dimensions (H × W × D)		Net	in (mm)	1-15/16 × 27-9/16 × 27-9/16 (49 × 700 × 700)		
					Gross		4-3/4 × 30-1/8 × 29-3/4 (120 × 765 × 755)		
Weight		Net	lb (kg)	5.7 (2.6)					
		Gross		10 (4.5)					
Remote controller type			Wired (Wireless [option])						
NOTES: • The protective function might work when using it outside the operation range. *: These are the measured values in the manufacturer's anechoic chamber. Because of the surrounding sound environment, the sound levels measured in actual installation conditions might be higher than the specified values here.									

3-2. Slim duct type

Model name				ARU7RLF	ARU9RLF	ARU12RLF	
Power supply				208/230 V ~ 60 Hz			
Available voltage range				187—264 V			
Capacity			Btu/h class	7,000	9,000	12,000	
Input power			W	33	49	58	
Running current			A	0.30	0.30	0.35	
Fan	Airflow rate	Cooling	HIGH	CFM (m ³ /h)	324 (550)	353 (600)	383 (650)
			MED		288 (490)	324 (550)	353 (600)
			LOW		277 (470)	294 (500)	324 (550)
			QUIET		259 (440)	265 (450)	283 (480)
		Heating	HIGH		324 (550)	353 (600)	383 (650)
			MED		288 (490)	324 (550)	353 (600)
			LOW		277 (470)	294 (500)	324 (550)
			QUIET		259 (440)	265 (450)	283 (480)
	Type × Q'ty		Sirocco fan × 2				
	Motor output		W	80	81		
Recommended static pressure				inWG (Pa)	0 to 0.36 (0 to 90)		
Sound pressure level *	Cooling	HIGH	dB (A)	28	28	29	
				MED	26	27	28
				LOW	25	26	27
				QUIET	24	25	26
	Heating	HIGH		28	28	29	
				MED	26	26	28
				LOW	25	25	27
				QUIET	24	24	24
Heat exchanger type	Dimensions (H × W × D)		in (mm)	11-9/16 × 19-11/16 × 1-1/16 (294 × 500 × 26.6)	11-9/16 × 19-11/16 × 1-9/16 (294 × 500 × 39.9)		
	Fin pitch		FPI	20			
	Rows × Stages			2 × 14	3 × 14		
	Pipe type			Copper tube			
	Fin type			Aluminum			
Enclosure	Material			Galvanized steel sheet			
	Color			-			
Dimensions (H × W × D)	Net		in (mm)	7-13/16 × 27-9/16 × 24-7/16 (198 × 700 × 620)			
	Gross			10-13/16 × 37-3/16 × 30-3/8 (274 × 945 × 772)			
Weight	Net		lb (kg)	37 (17)		40 (18)	
	Gross			49 (22)		51 (23)	
Connection pipe	Size	Liquid	in (mm)	Ø1/4 (Ø6.35)			
		Gas		Ø3/8 (Ø9.52)			
	Method			Flare			
Drain hose	Material			Hard PVC			
	Size		in (mm)	Ø 3/4 (I.D.), Ø 1-1/16 (O.D.) [Ø 20.7 (I.D.), Ø 26.6 (O.D.)]			
Operation range	Cooling	°F (°C)		64 to 90 (18 to 32)			
		%RH		80 or less			
Operation range	Heating	°F (°C)		60 to 88 (16 to 31)			
		Remote controller type		Wired (Wireless [option])			
NOTES: <ul style="list-style-type: none"> • Specifications are based on the following conditions. <ul style="list-style-type: none"> - Standard static pressure: 0.10 inWG (25 Pa) • The protective function might work when using it outside the operation range. • *Sound pressure level: <ul style="list-style-type: none"> - Measured values in manufacturer's anechoic chamber. - Because of the surrounding sound environment, the sound levels measured in actual installation conditions might be higher than the specified values here. 							

Model name				ARU18RLF	ARU24RLF	
Power supply				208/230 V ~ 60 Hz		
Available voltage range				187—264 V		
Capacity		Btu/h class		18,000	24,000	
Input power		W		73	111	
Running current		A		0.44	0.66	
Fan	Airflow rate	Cooling	HIGH	CFM (m ³ /h)	554 (940)	783 (1,330)
			MED		518 (880)	730 (1,240)
			LOW		483 (820)	648 (1,100)
			QUIET		441 (750)	607 (1,030)
		Heating	HIGH		554 (940)	783 (1,330)
			MED		518 (880)	730 (1,240)
			LOW		483 (820)	648 (1,100)
			QUIET		441 (750)	607 (1,030)
	Type × Q'ty				Sirocco × 3	Sirocco × 4
	Motor output		W		81	
Recommended static pressure			inWG (Pa)	0 to 0.36 (0 to 90)	0 to 0.20 (0 to 50)	
Sound pressure level *2	Cooling	HIGH	dB (A)	32	33	
		MED		31	32	
		LOW		30	30	
		QUIET		29	29	
	Heating	HIGH		33	35	
		MED		32	34	
		LOW		31	32	
		QUIET		29	29	
Heat exchanger type	Dimensions (H × W × D)		in (mm)	11-9/16 × 27-9/16 × 1-9/16 (294 × 700 × 39.9)	11-9/16 × 35-7/16 × 1-9/16 (294 × 900 × 39.9)	
	Fin pitch		FPI	20		
	Rows × Stages		3 × 14			
	Pipe type		Copper tube			
	Fin type		Aluminum			
Enclosure	Material			Galvanized steel sheet		
	Color			-		
Dimensions (H × W × D)	Net		in (mm)	7-13/16 × 35-7/16 × 24-7/16 (198 × 900 × 620)	7-13/16 × 43-5/16 × 24-7/16 (198 × 1,100 × 620)	
	Gross			10-13/16 × 45-1/16 × 30-3/8 (274 × 1,145 × 772)	10-13/16 × 52-15/16 × 30-3/8 (274 × 1,345 × 772)	
Weight	Net		lb (kg)	49 (22)	55 (25)	
	Gross			60 (27)	68 (31)	
Connection pipe	Size	Liquid	mm (in)	Ø1/4 (Ø6.35)		
		Gas		Ø1/2 (Ø12.70)	Ø5/8 (Ø15.88)	
	Method			Flare		
Drain hose	Material			HARD PVC		
	Size		in (mm)	Ø 3/4(I.D.), Ø 1-1/16(O.D.) [Ø 20.7 (I.D.), Ø 26.6 (O.D.)]		
Operation range	Cooling	°F (°C)		64 to 90 (18 to 32)		
		%RH		80 or less		
	Heating	°F (°C)		60 to 88 (16 to 31)		
Remote controller type				Wired (Wireless [option])		
NOTES: <ul style="list-style-type: none"> • Specifications are based on the following conditions. <ul style="list-style-type: none"> – Standard static pressure: 0.10 inWG (25 Pa) • The protective function might work when using it outside the operation range. • *Sound pressure level: <ul style="list-style-type: none"> – Measured values in manufacturer's anechoic chamber. – Because of the surrounding sound environment, the sound levels measured in actual installation conditions might be higher than the specified values here. 						

3-3. Wall mounted type

Model name				ASU7RLF1	ASU9RLF1	ASU12RLF1	ASU15RLF1		
Power supply				208/230 V ~ 60 Hz					
Available voltage range				187—264 V					
Capacity			Btu/h class	7,000	9,000	12,000	14,000		
Input power			W	15	17	22	28		
Running current			A	0.13	0.15	0.19	0.25		
Fan	Airflow rate	Cooling	HIGH	CFM (m ³ /h)	330 (560)	353 (600)	388 (660)	430 (730)	
			MED		294 (500)	306 (520)	330 (560)	353 (600)	
			LOW		253 (430)	253 (430)	265 (450)	312 (530)	
			QUIET		182 (310)	182 (310)	182 (310)	212 (360)	
		Heating	HIGH		330 (560)	353 (600)	388 (660)	430 (730)	
			MED		294 (500)	306 (520)	330 (560)	362 (615)	
			LOW		253 (430)	253 (430)	277 (470)	330 (560)	
			QUIET		194 (330)	194 (330)	194 (330)	221 (375)	
	Type × Q'ty		Cross flow fan × 1						
	Motor output		W	30					
Sound pressure level *			Cooling	dB (A)	HIGH	36	37	40	42
					MED	32	33	36	38
					LOW	29	29	30	33
					QUIET	21	21	21	25
			Heating		HIGH	36	37	40	42
					MED	32	33	36	38
					LOW	29	29	31	35
					QUIET	22	22	22	27
Heat exchanger type			Dimensions (H × W × D)	in (mm)	Main: 12-5/8 × 24-13/16 × 13/16 (320 × 630 × 20) Sub: 3-5/16 × 24-13/16 × 1/2 (84 × 630 × 13.3)				
			Fin pitch	FPI	Main: 23, Sub: 18				
			Rows × Stages	Main: 2 × 20, Sub: 1 × 4					
			Pipe type	Copper tube					
			Fin type	Aluminum					
Enclosure	Material			Polystyrene					
	Color			White (Approximate color of MUNSELL N9.25 /)					
Dimensions (H × W × D)	Net		in (mm)	10-9/16 × 33-1/16 × 8 (268 × 840 × 203)					
	Gross			10-5/8 × 34-13/16 × 14-3/4 (270 × 884 × 336)					
Weight	Net		lb (kg)	19 (8.5)					
	Gross			23 (10.5)					
Connection pipe	Size	Liquid	in (mm)	Ø1/4 (Ø6.35)					
		Gas		Ø3/8 (Ø9.52)		Ø1/2 (Ø12.70)			
	Method			Flare					
Drain hose	Material			PP + LLDPE					
	Size		in (mm)	Ø 9/16(I.D.), Ø 5/8 to Ø 11/16(O.D.) [Ø 13.8(I.D.), Ø 15.8 to Ø 16.7(O.D.)]					
Operation range		Cooling	°F (°C)	64 to 90 (18 to 32)					
			%RH	80 or less					
		Heating	°F (°C)	60 to 88 (16 to 31)					
Remote controller type				Wireless (Wired [option])					
NOTES: <ul style="list-style-type: none"> The protective function might work when using it outside the operation range. *Sound pressure level: <ul style="list-style-type: none"> Measured values in manufacturer's anechoic chamber. Because of the surrounding sound environment, the sound levels measured in actual installation conditions might be higher than the specified values here. 									

Model name				ASU18RLF	ASU24RLF	
Power supply				208/230 V ~ 60 Hz		
Available voltage range				187—264 V		
Capacity		Btu/h class		18,000	24,000	
Input power		W		41	69	
Running current		A		0.32	0.53	
Fan	Airflow rate	Cooling	HIGH	CFM (m ³ /h)	542 (920)	659 (1,120)
			MED		436 (740)	530 (900)
			LOW		365 (620)	436 (740)
			QUIET		324 (550)	365 (620)
		Heating	HIGH		542 (920)	647 (1,100)
			MED		436 (740)	530 (900)
			LOW		365 (620)	436 (740)
			QUIET		324 (550)	365 (620)
	Type × Q'ty		Cross flow fan ×1			
	Motor output		W		42	
Sound pressure level *	Cooling	HIGH	dB (A)	43	49	
		MED		37	42	
		LOW		33	37	
		QUIET		31	33	
	Heating	HIGH		44	48	
		MED		37	42	
		LOW		33	37	
		QUIET		31	33	
Heat exchanger type	Dimensions (H × W × D)		in (mm)	Main: 15-7/8 × 33-3/4 × 1-1/16 (378 × 832 × 26.6) Sub: 3-5/16 × 33-3/4 × 1/2 (84 × 832 × 13.3)		
	Fin pitch		FPI	Main: 21, Sub: 18		
	Rows × Stages			Main: 2 × 18, Sub: 1 × 4		
	Pipe type			Copper tube		
	Fin type			Aluminum		
Enclosure	Material			Polystyrene		
	Color			White (Approximate color of MUNSELL N9.25 /)		
Dimensions (H × W × D)	Net		in (mm)	12-5/8 × 39-1/4 × 9 (320 × 998 × 228)		
	Gross			12-9/16 × 42-15/16 × 16-7/8 (319 × 1,090 × 429)		
Weight	Net		lb (kg)	31 (14)		
	Gross			40 (18)		
Connection pipe	Size	Liquid	mm (in)	Ø1/4 (Ø6.35)		
		Gas		Ø1/2 (Ø12.70)	Ø5/8 (Ø15.88)	
	Method			Flare		
Drain hose	Material			PVC		
	Size		in (mm)	Ø 1/2(I.D.), Ø 5/8(O.D.) [Ø 12(I.D.), Ø 16(O.D.)]		
Operation range	Cooling		°F (°C)	64 to 90 (18 to 32)		
			%RH	80 or less		
		Heating		°F (°C)		
				60 to 88 (16 to 31)		
Remote controller type				Wireless (Wired [option])		
<p>NOTES:</p> <ul style="list-style-type: none"> •The protective function might work when using it outside the operation range. •*Sound pressure level: <ul style="list-style-type: none"> –Measured values in manufacturer's anechoic chamber. –Because of the surrounding sound environment, the sound levels measured in actual installation conditions might be higher than the specified values here. 						

3-4. Floor type

Model name				AGU9RLF	AGU12RLF	AGU15RLF	
Power supply				208/230 V ~ 60 Hz			
Available voltage range				187—264 V			
Capacity			Btu/h class	9,000	12,000	14,000	
Input power				W	16	23	
Running current				A	0.15	0.20	
Fan	Airflow rate	Cooling	HIGH	CFM (m ³ /h)	312 (530)	353 (600)	383 (650)
			MED		259 (440)	288 (490)	306 (520)
			LOW		212 (360)	224 (380)	235 (400)
			QUIET		159 (270)	159 (270)	159 (270)
		Heating	HIGH		312 (530)	353 (600)	383 (650)
			MED		270 (460)	300 (510)	318 (540)
			LOW		224 (380)	241 (410)	253 (430)
			QUIET		159 (270)	159 (270)	159 (270)
	Type × Q'ty		Cross flow fan × 2				
	Motor output			W	16		
Sound pressure level *	Cooling	HIGH	dB (A)	39	42	44	
		MED		34	36	38	
		LOW		28	30	31	
		QUIET		22	22	22	
	Heating	HIGH		39	42	44	
		MED		35	38	39	
		LOW		30	32	33	
		QUIET		22	22	22	
Heat exchanger type	Dimensions (H × W × D)		in (mm)	14-7/8 × 21-5/8 × 1-1/16 (378 × 550 × 26.6)			
	Fin pitch		FPI	21			
	Rows × Stages		2 × 18				
	Pipe type		Copper tube				
	Fin type		Aluminium				
Enclosure	Material			Polystyrene			
	Color			White (Approximate color of MUNSELL N9.25/)			
Dimensions (H × W × D)	Net		in (mm)	23-5/8 × 29-1/8 × 7-7/8 (600 × 740 × 200)			
	Gross			27-9/16 × 32-5/16 × 12-3/16 (700 × 820 × 310)			
Weight	Net		lb (kg)	31 (14)			
	Gross			37 (17)			
Connection pipe	Size	Liquid	in (mm)	Ø1/4 (Ø 6.35)			
		Gas		Ø3/8 (Ø 9.52)	Ø1/2 (Ø 12.70)		
	Method			Flare			
Drain hose	Material			PVC			
	Size		in (mm)	Ø 9/16 (I.D.), Ø 11/16 (O.D.) [Ø 13.8 (I.D.), Ø 16.7 (O.D.)]			
Operation range	Cooling		°F (°C)	64 to 90 (18 to 32)			
	Heating		%RH	80 or less			
				°F (°C)	60 to 86 (16 to 30)		
Remote controller type				Wireless (Wired [option])			
NOTES:							
<ul style="list-style-type: none"> • The protective function might work when using it outside the operation range. • *Sound pressure level: <ul style="list-style-type: none"> – Measured values in manufacturer's anechoic chamber. – Because of the surrounding sound environment, the sound levels measured in actual installation conditions might be higher than the specified values here. 							

4. Dimensions

4-1. Compact cassette type

■ Models: AUU7RLF, AUU9RLF, AUU12RLF, and AUU18RLF

Unit: in. (mm)

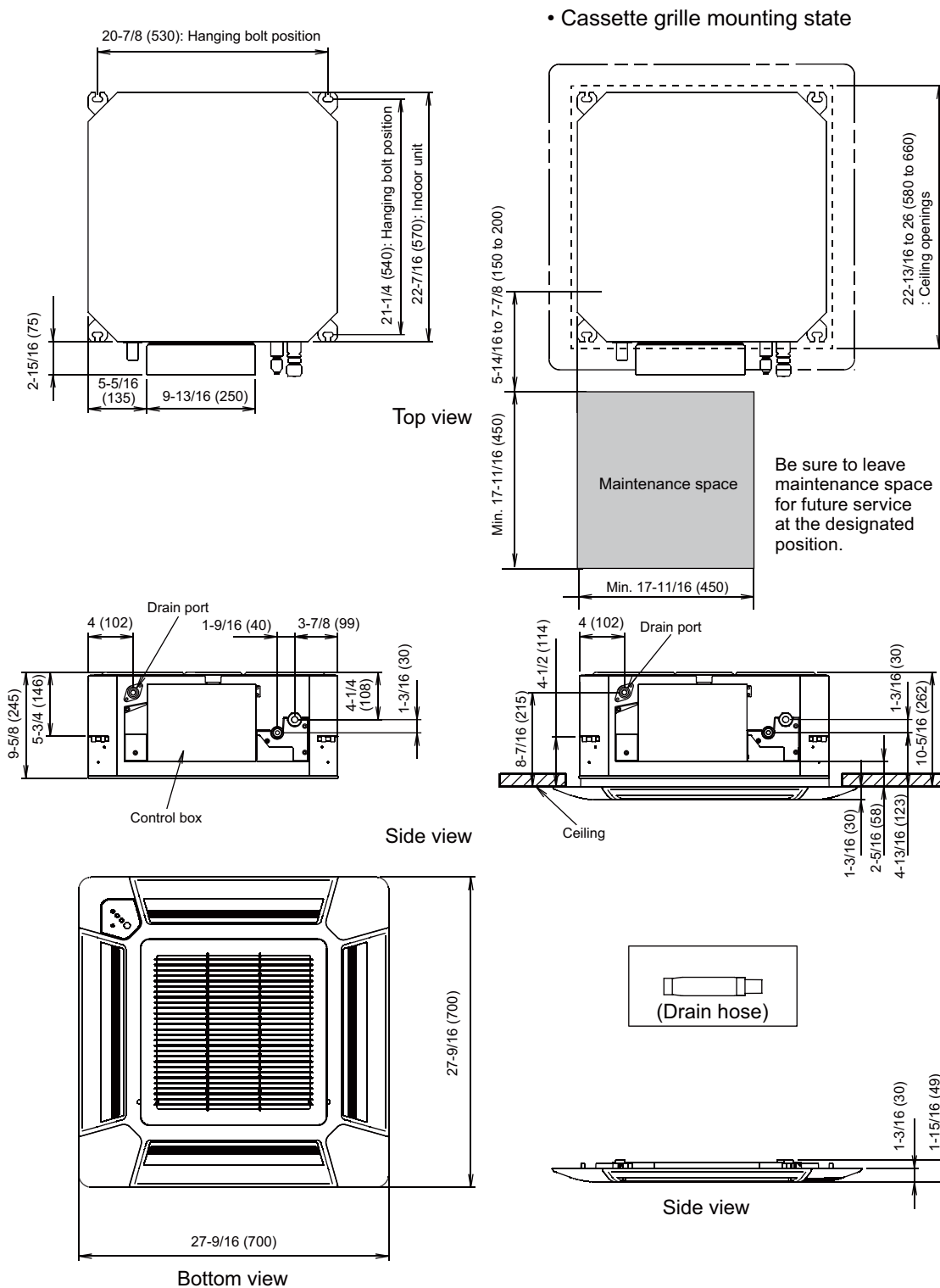

■ Installation space

Unit: in (mm)

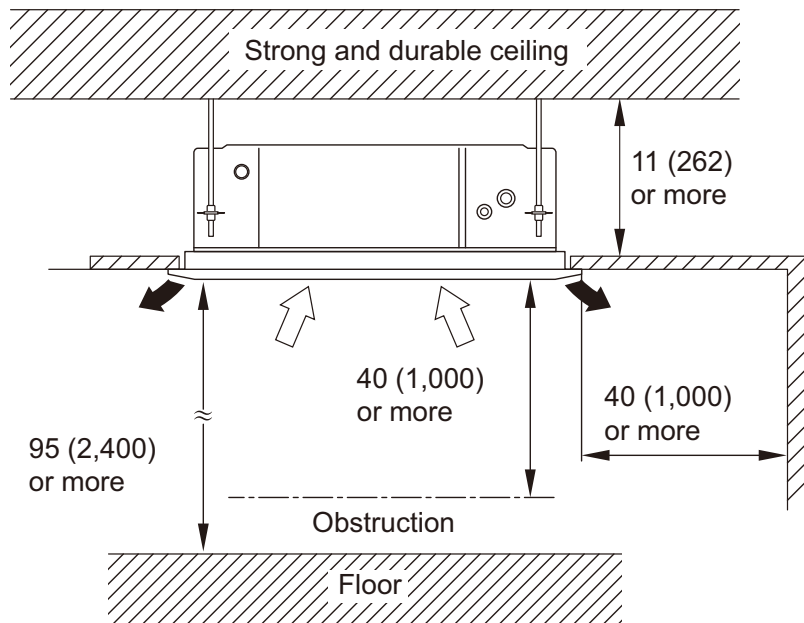

	Maximum height from floor to ceiling (Unit: mm)			
Model name	AUU7	AUU9	AUU12	AUU18
Standard mode	107 (2,700)			
High Ceiling mode	-		119 (3,000)	

• 3-way direction setting

Unit: in (mm)

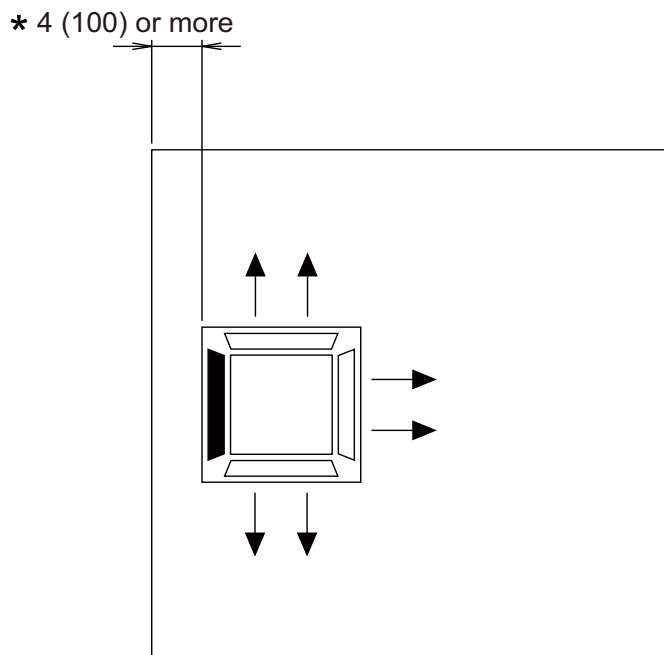

NOTES:

- To set "3-direction", optional Air outlet shutter plate (UTR-YDZB) must be installed, and the "outlet-direction" need to be switched to "3-way" by remote controller.
*When installing the indoor unit, be careful about the maintenance space.
- The ceiling height cannot be set in the 3-way outlet mode. Therefore, ceiling height setting change by function setting 20 is prohibited. For details, refer to Chapter 13-5. "[Contents of function setting](#)" on page 149.

4-2. Slim duct type

■ Models: ARU7RLF, ARU9RLF, and ARU12RLF

Unit: in (mm)

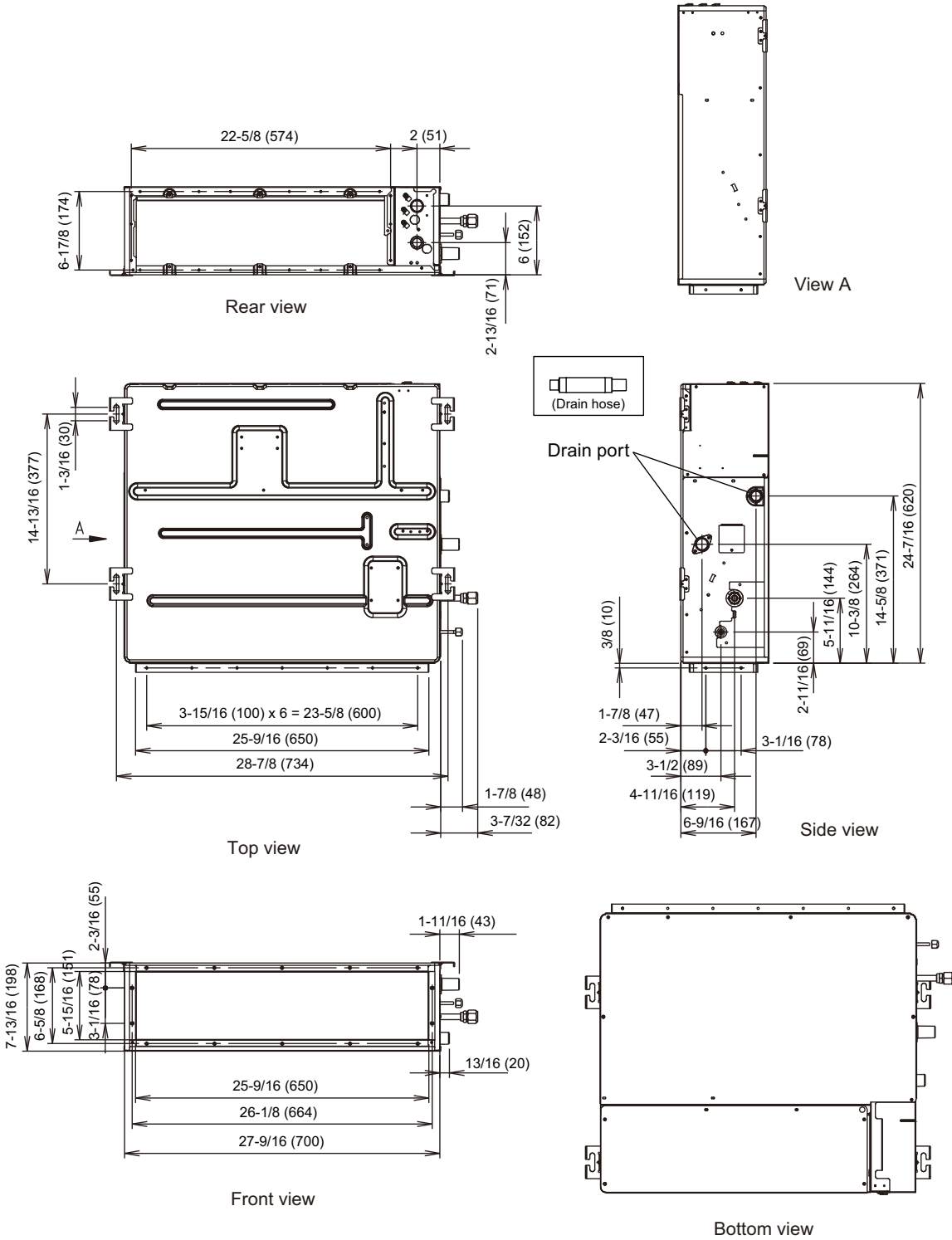

Model: ARU18RLF

Unit: in (mm)

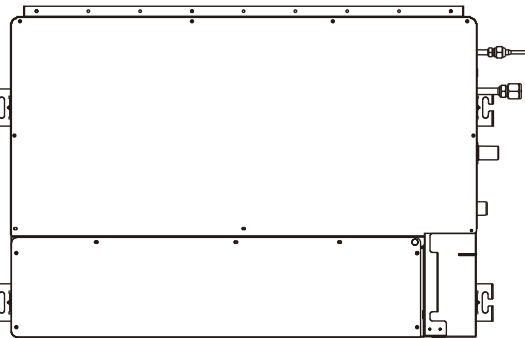
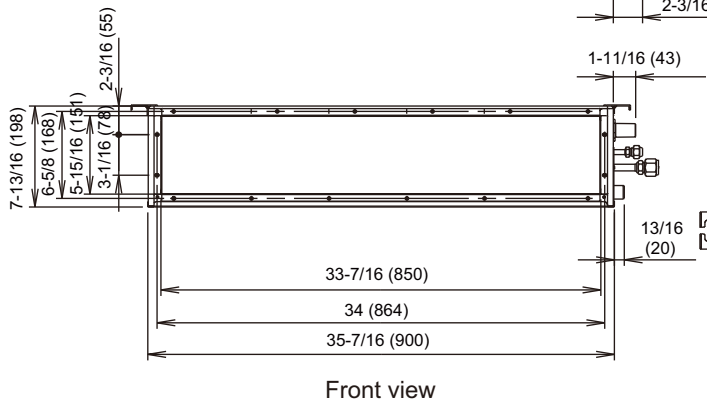
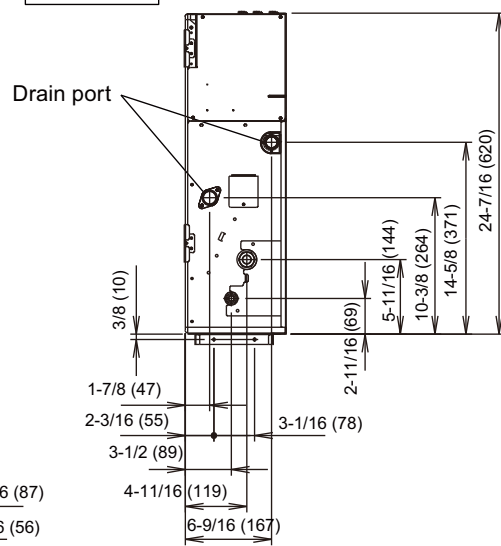
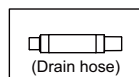
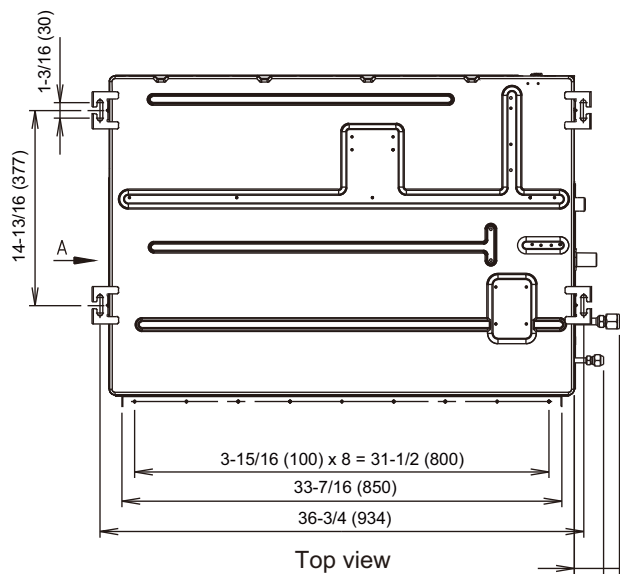
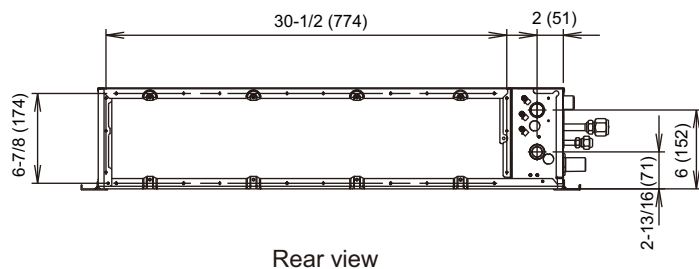

Model: ARU24RLF

Unit in (mm)

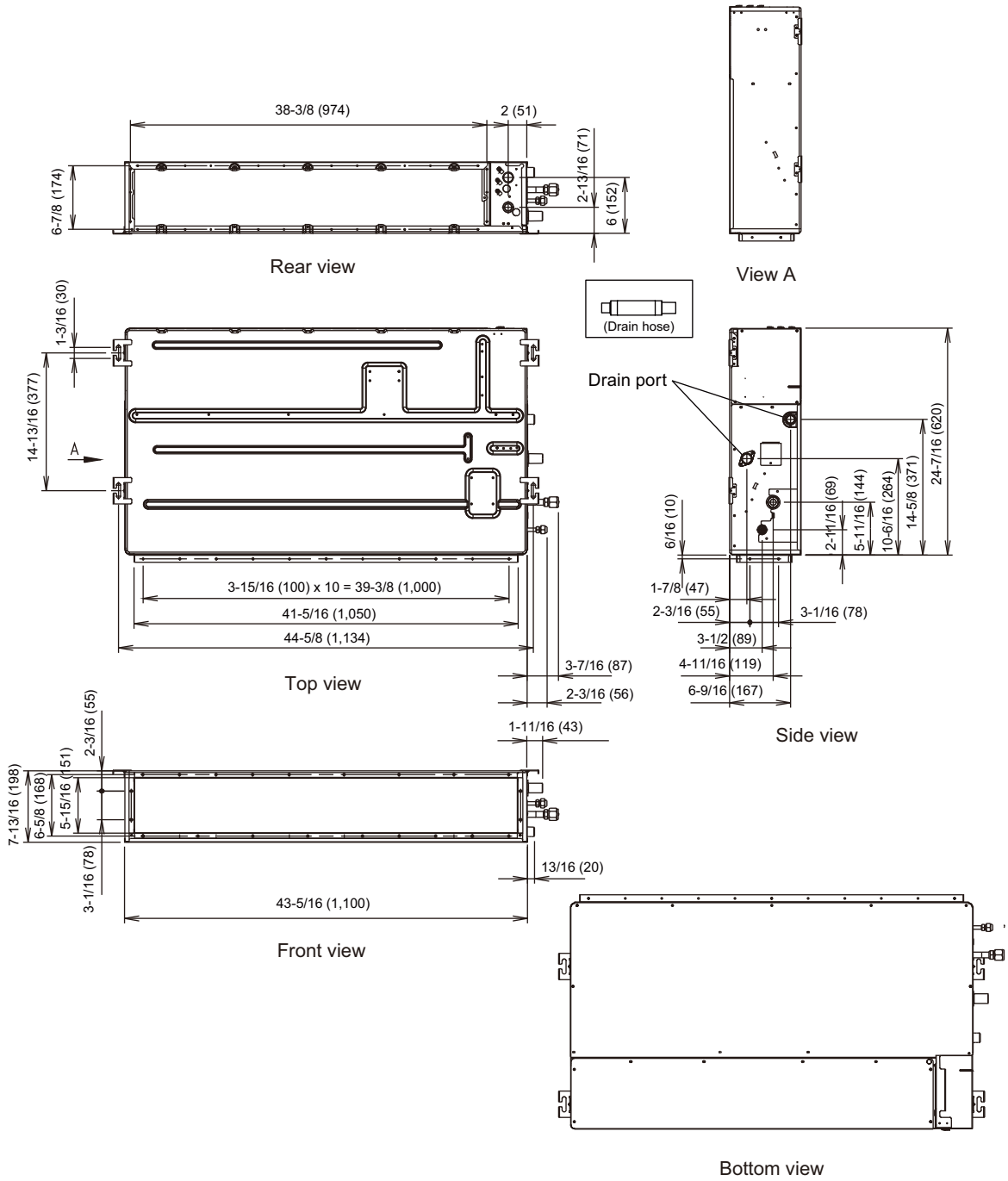

Installation space

Unit: in (mm)

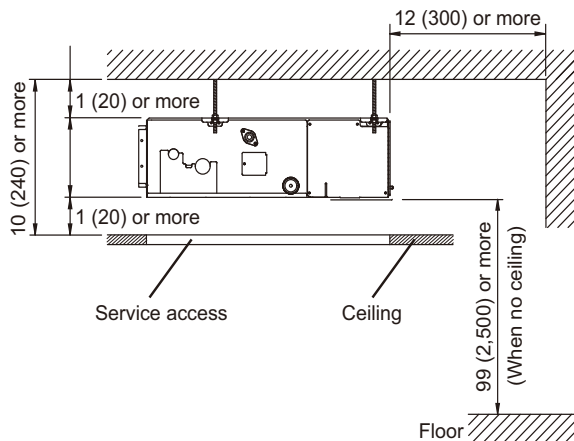
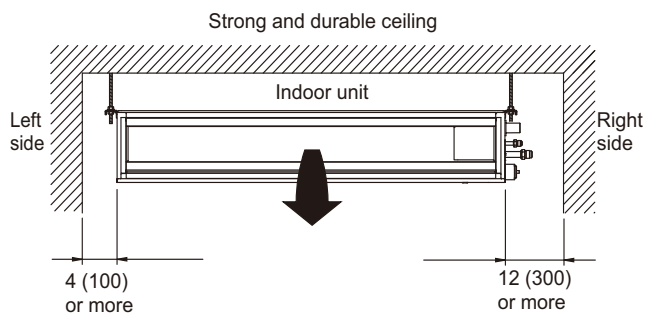

Unit: in (mm)

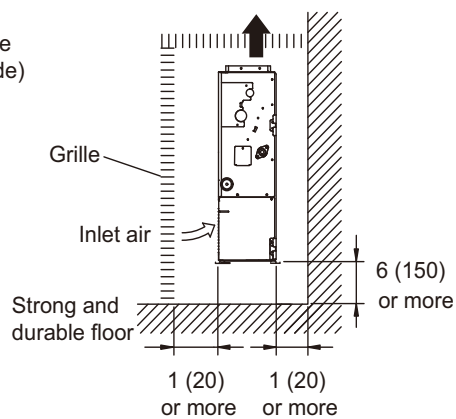
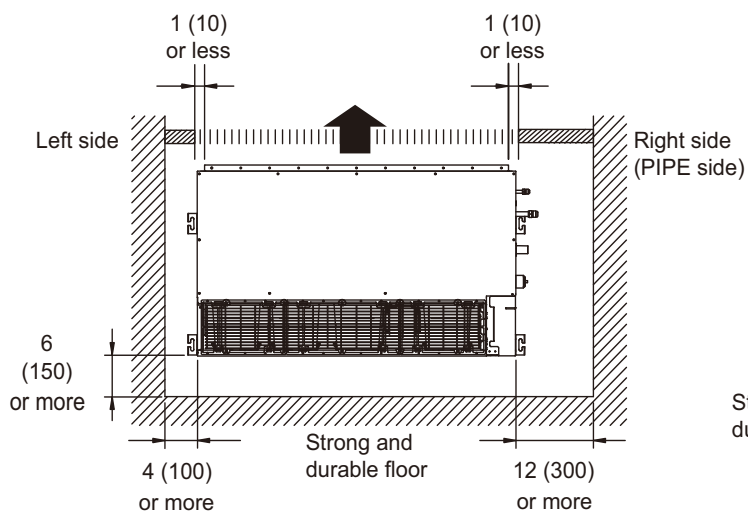

Unit: in (mm)

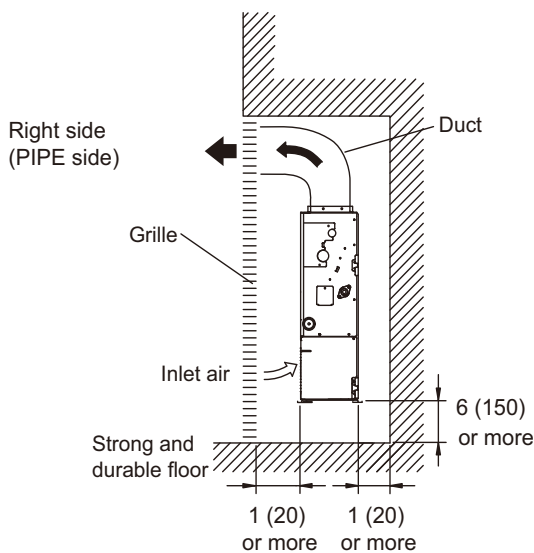
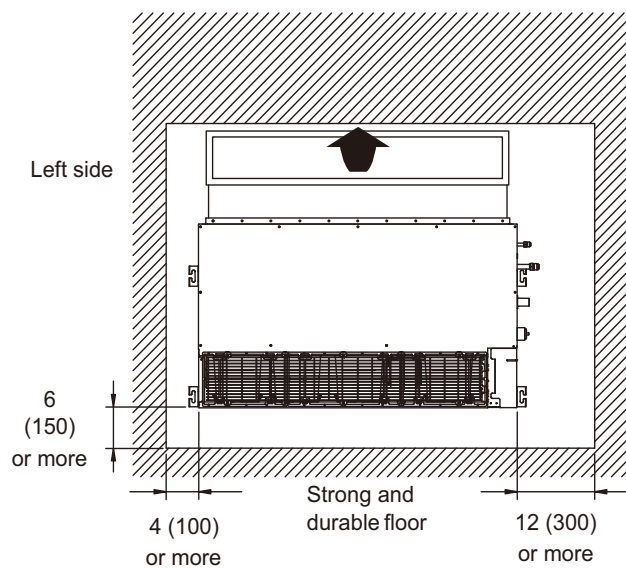

■ Maintenance space

Provide a service access for inspection purposes as shown below.

Do not place any wiring or illumination in the service space, as they will impede service.

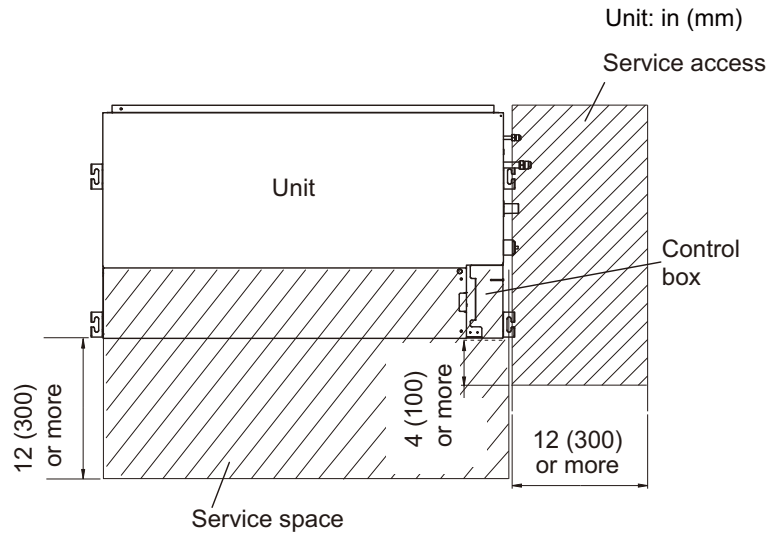

4-3. Wall mounted type

■ Models: ASU7RLF1, ASU9RLF1, ASU12RLF1, and ASU15RLF1

Unit: in (mm)

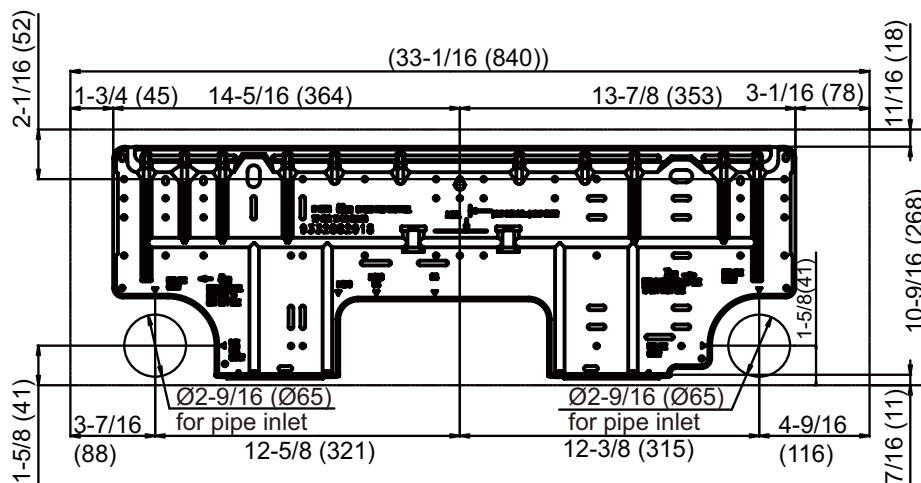
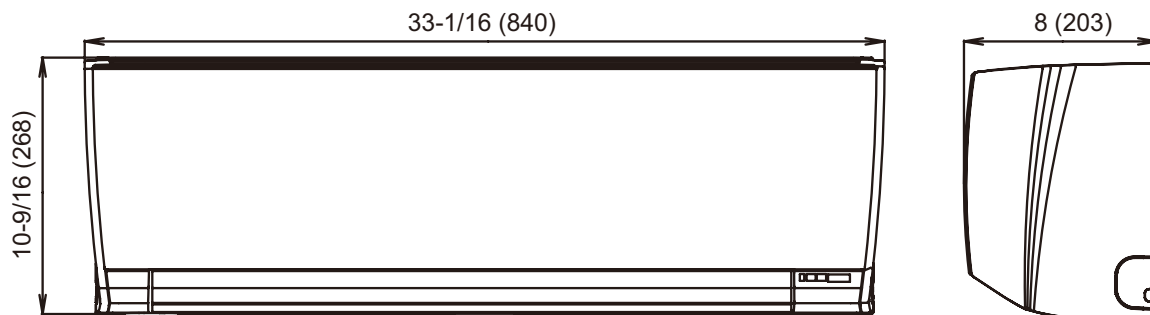

■ Installation space

Unit: in (mm)

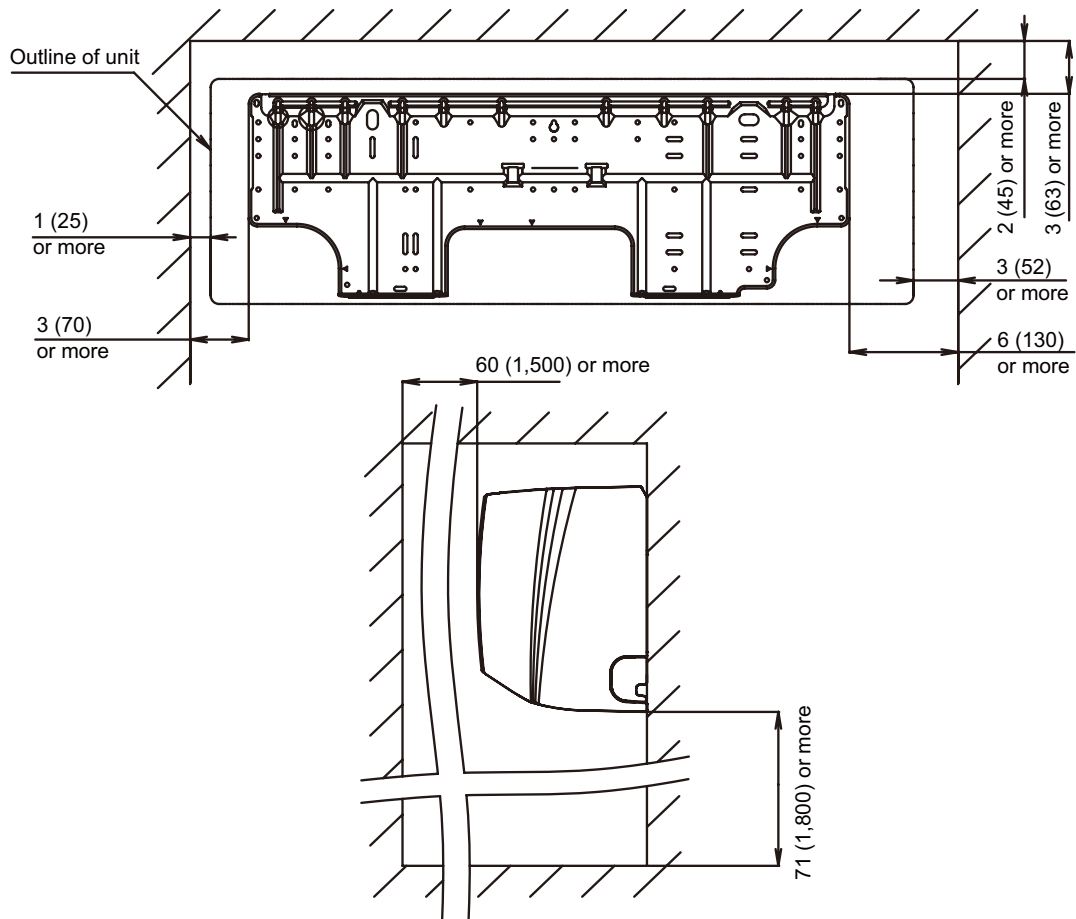

Models: ASU18RLF and ASU24RLF

Unit: in (mm)

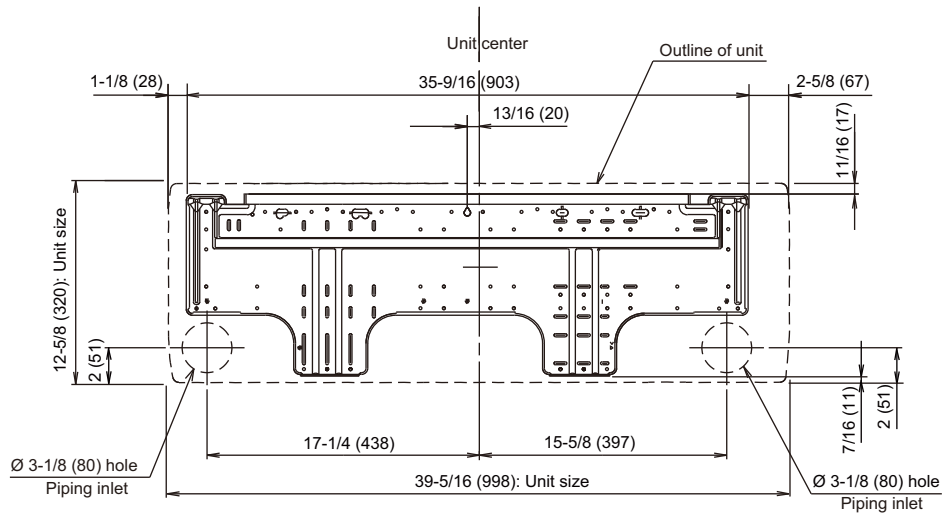
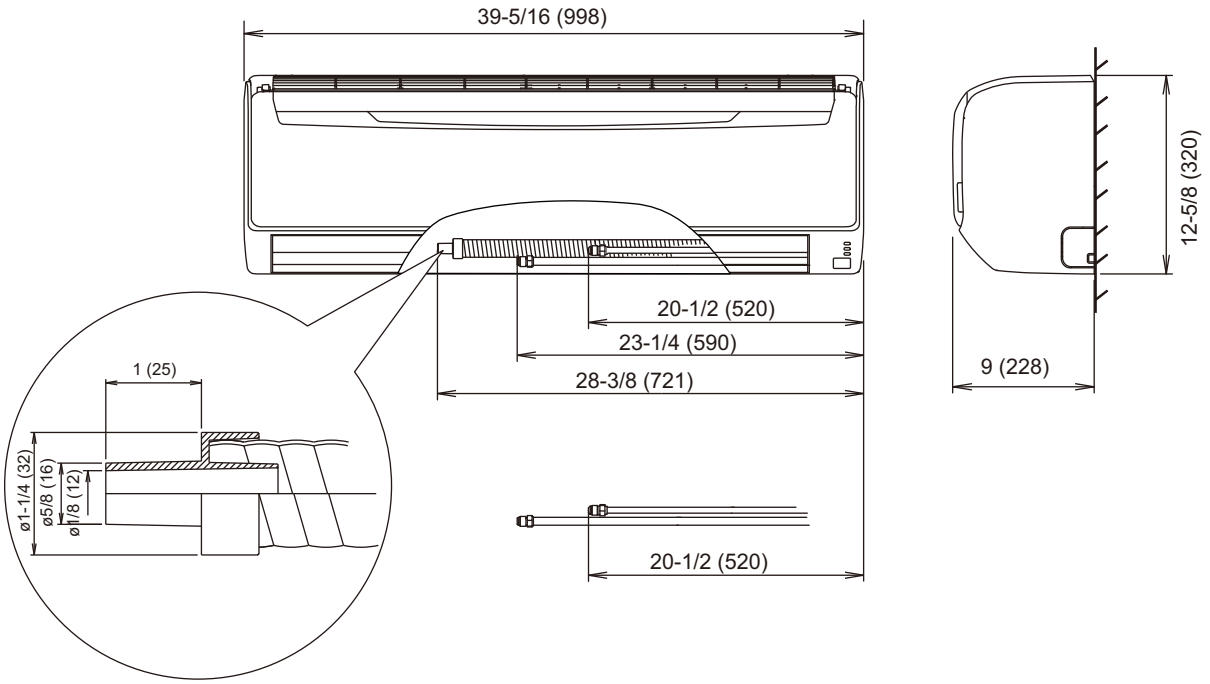

■ Installation space

Unit: in (mm)

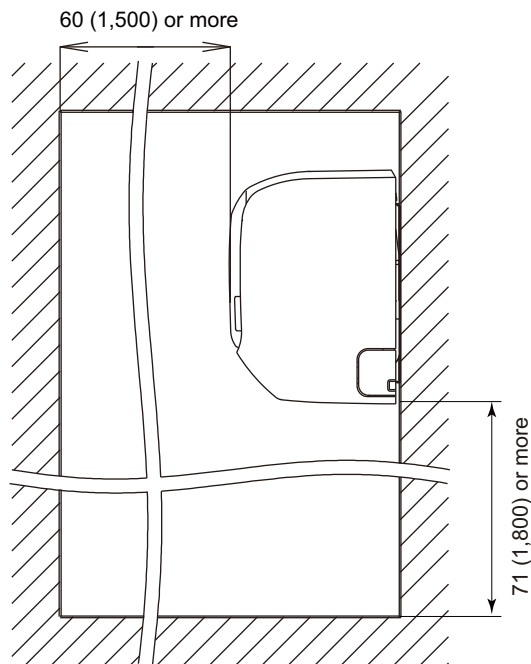
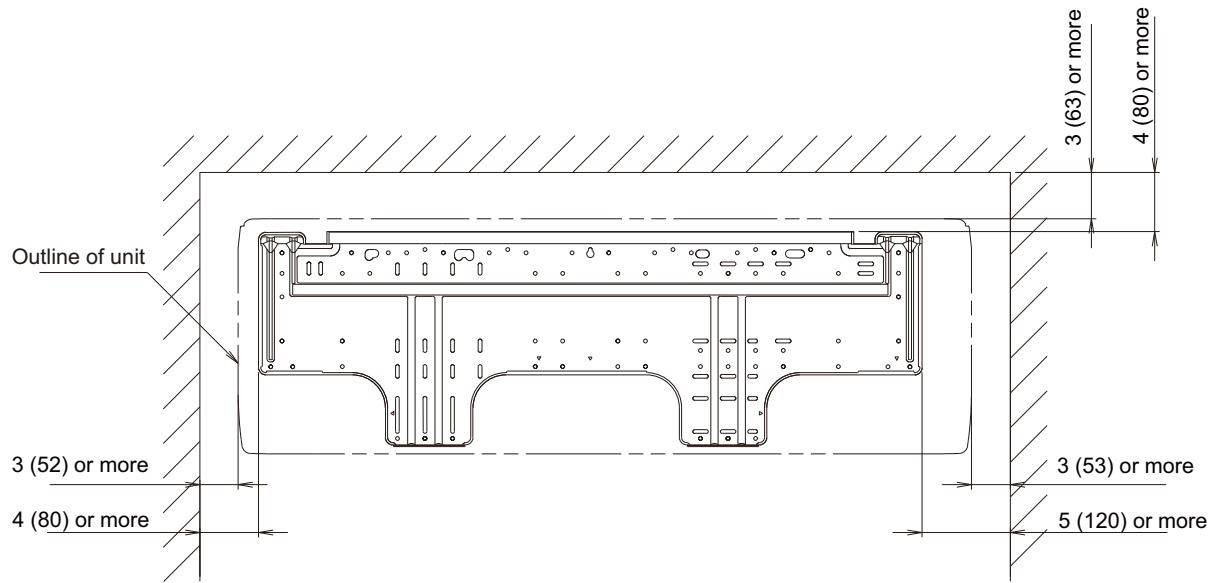

4-4. Floor type

■ Models: AGU9RLF, AGU12RLF, and AGU15RLF

Unit: in (mm)

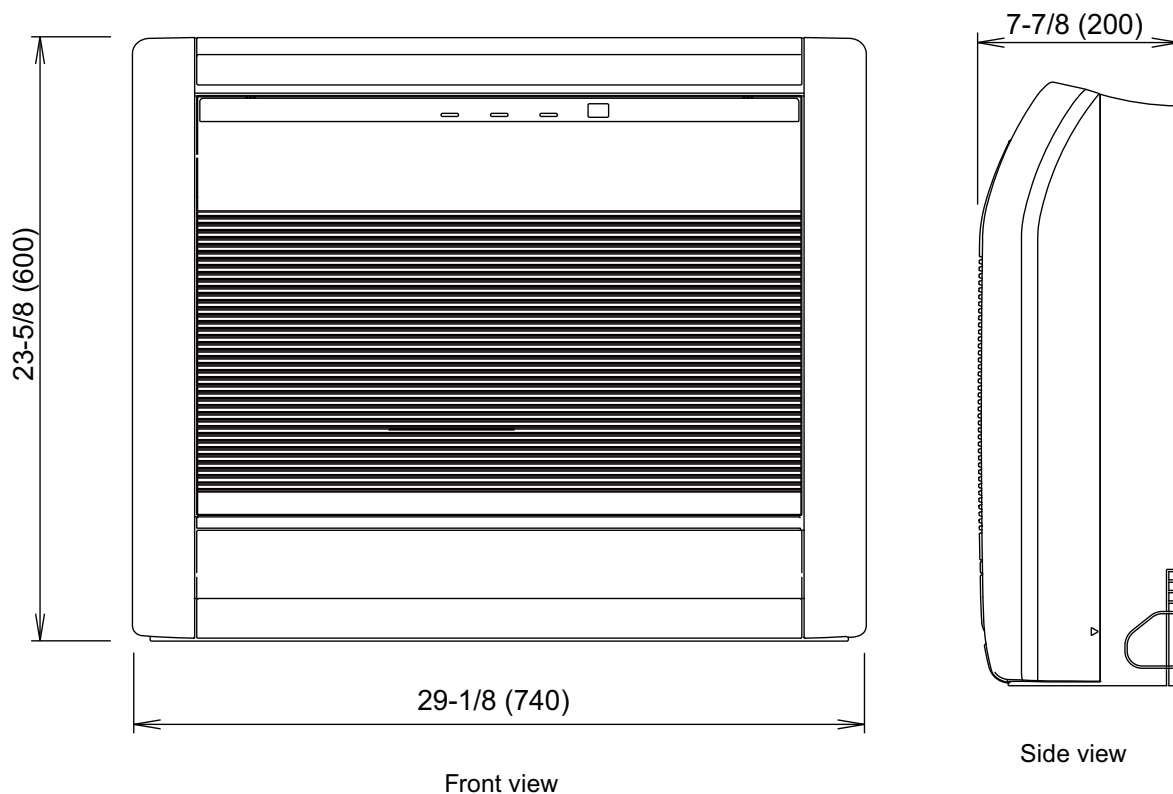

■ Installation space

Unit: in (mm)

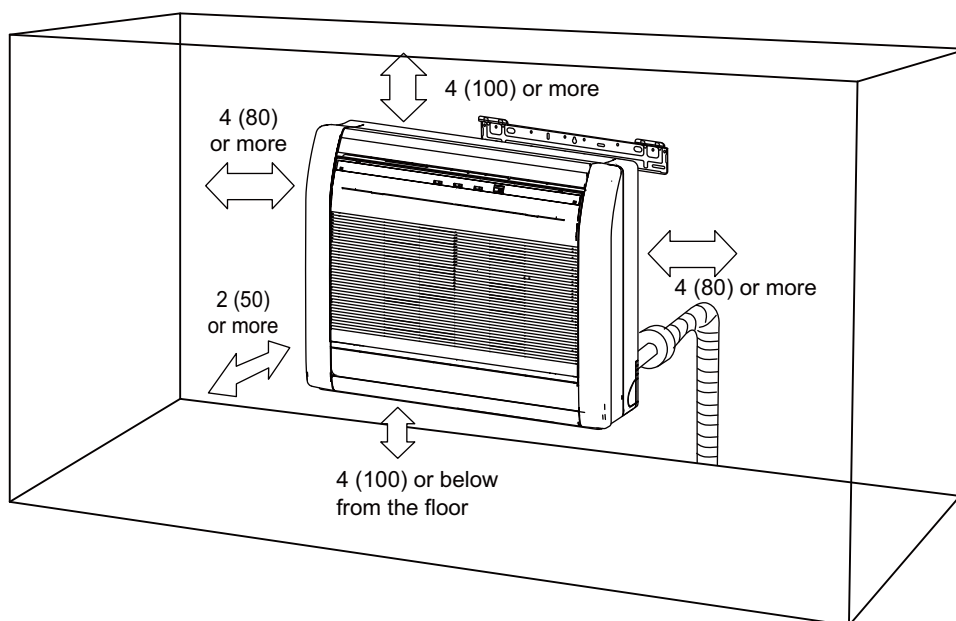

5. Wiring diagrams

5-1. Compact cassette type

■ Models: AUU7RLF, AUU9RLF, AUU12RLF, and AUU18RLF

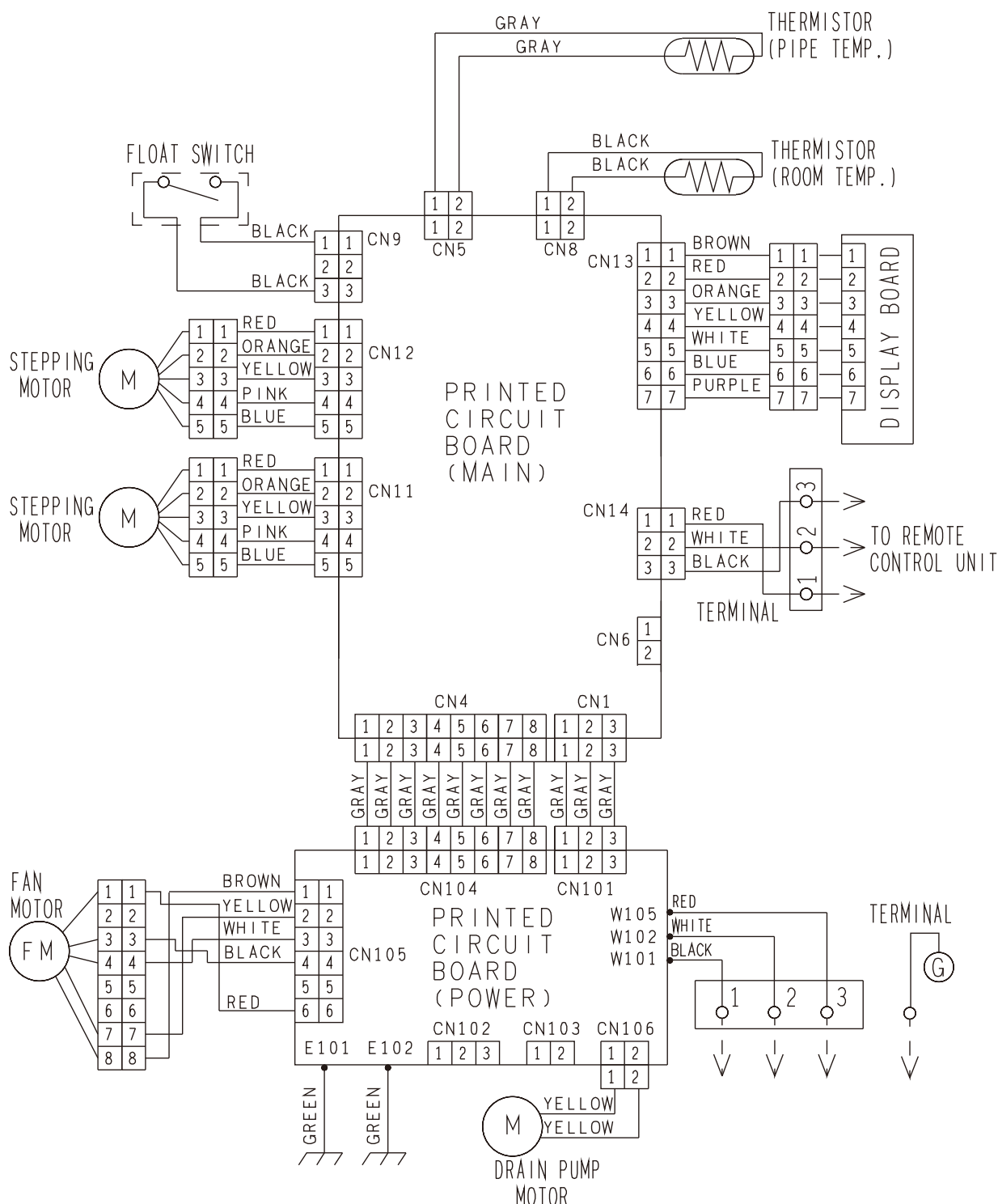

5-2. Slim duct type

■ Models: ARU7RLF, ARU9RLF, ARU12RLF, ARU18RLF, and ARU24RLF

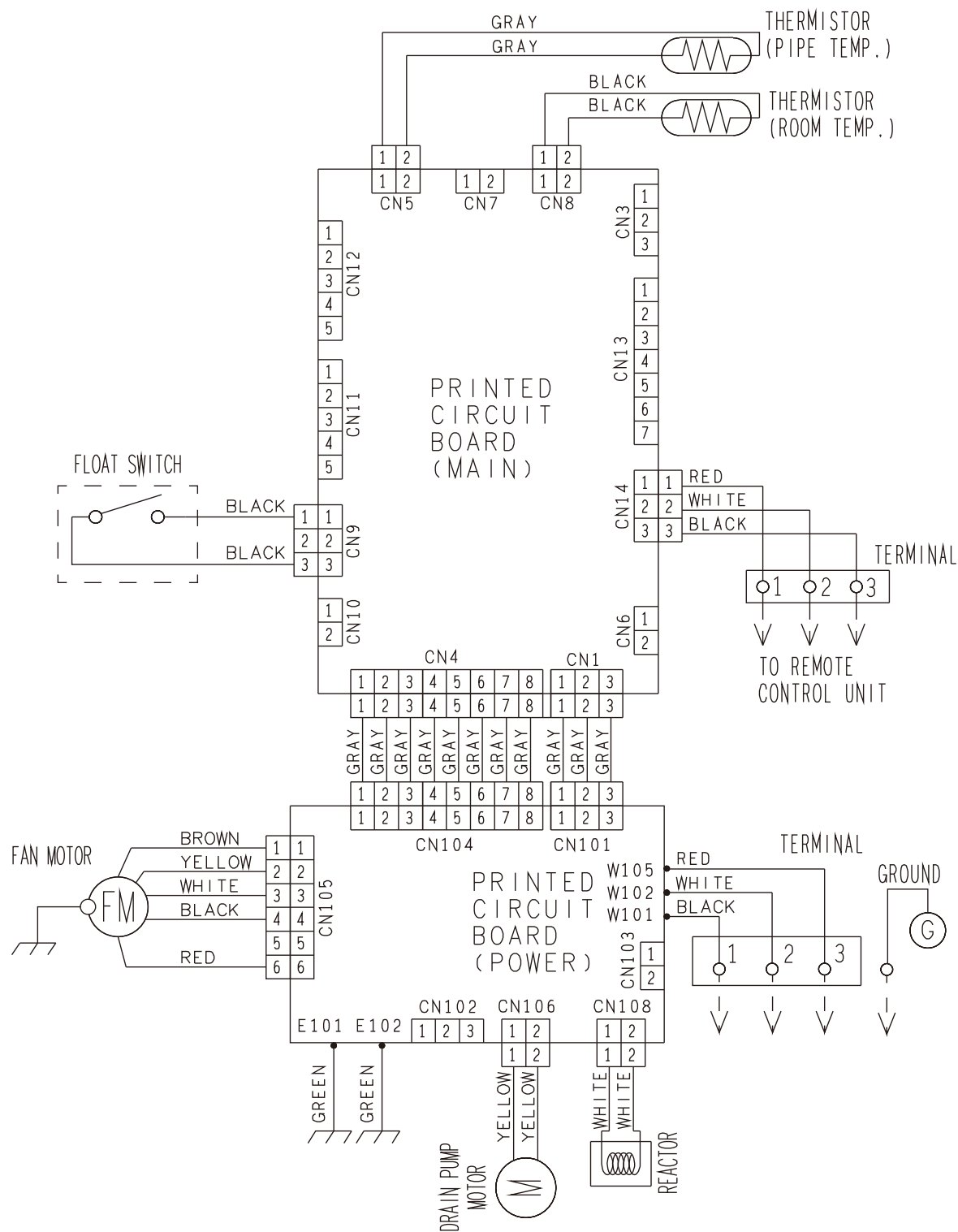

5-3. Wall mounted type

■ Models: ASU7RLF1, ASU9RLF1, ASU12RLF1, and ASU15RLF1

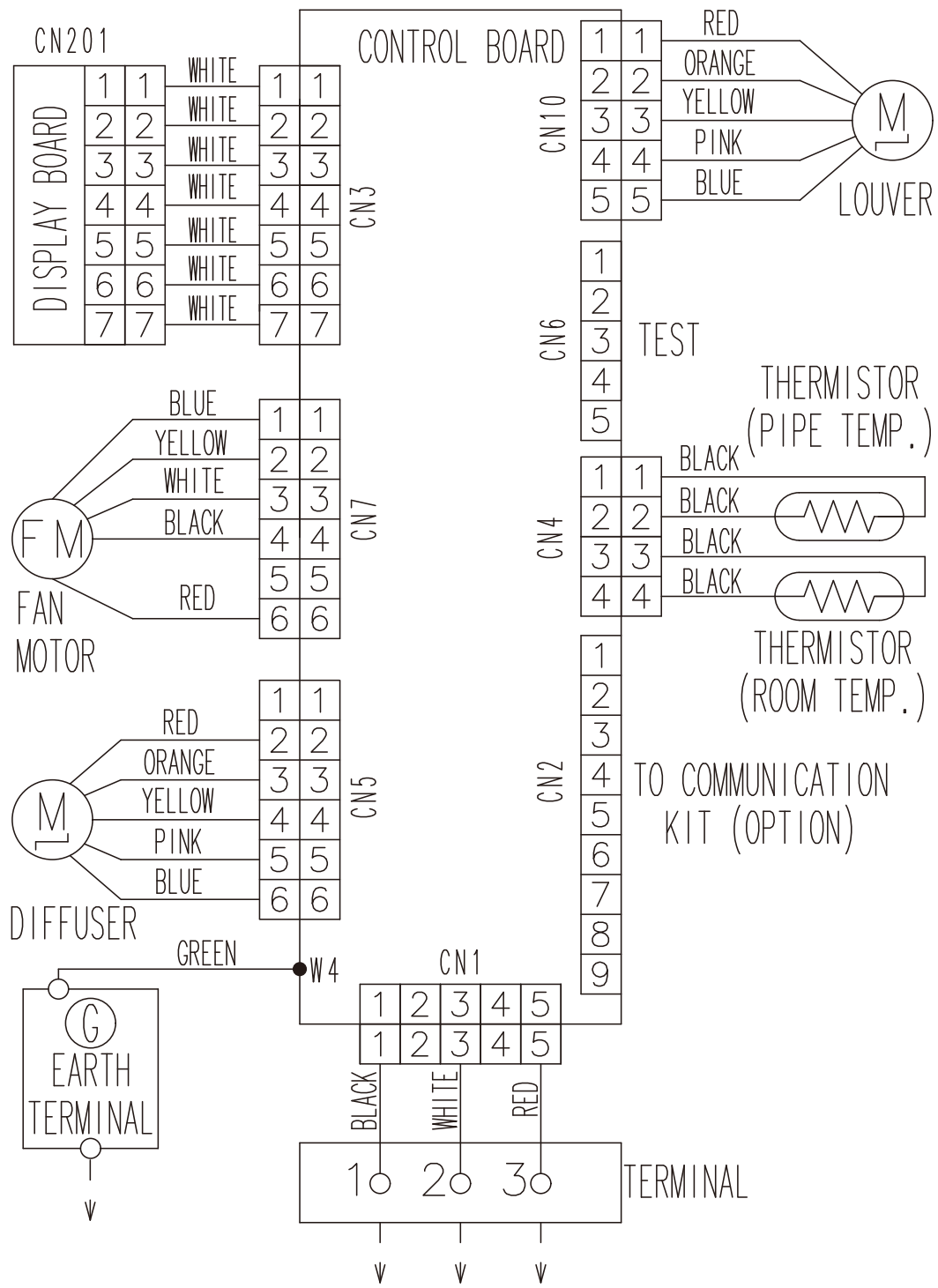

Models: ASU18RLF and ASU24RLF

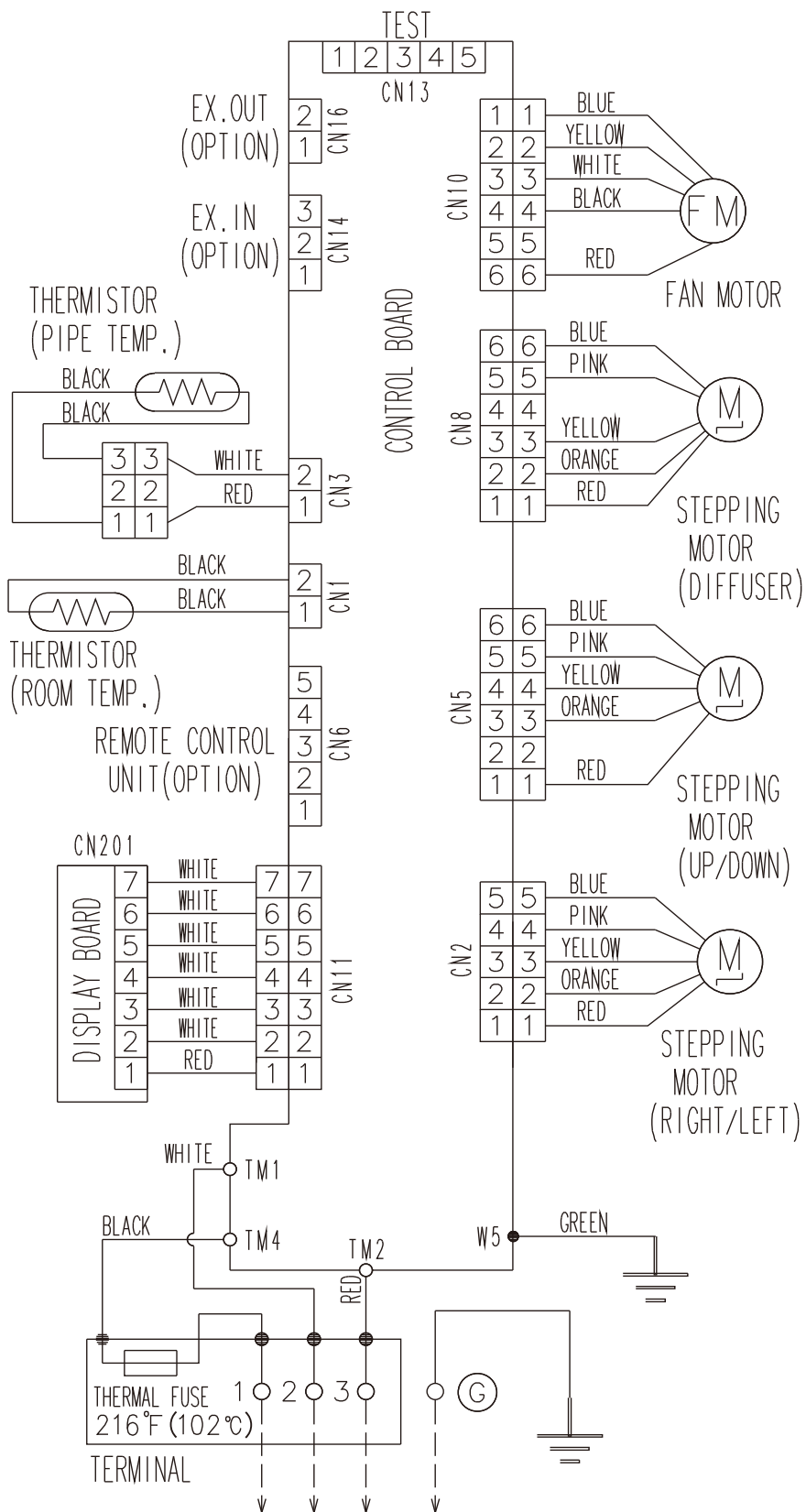

5-4. Floor type

Models: AGU9RLF, AGU12RLF, and AGU15RLF

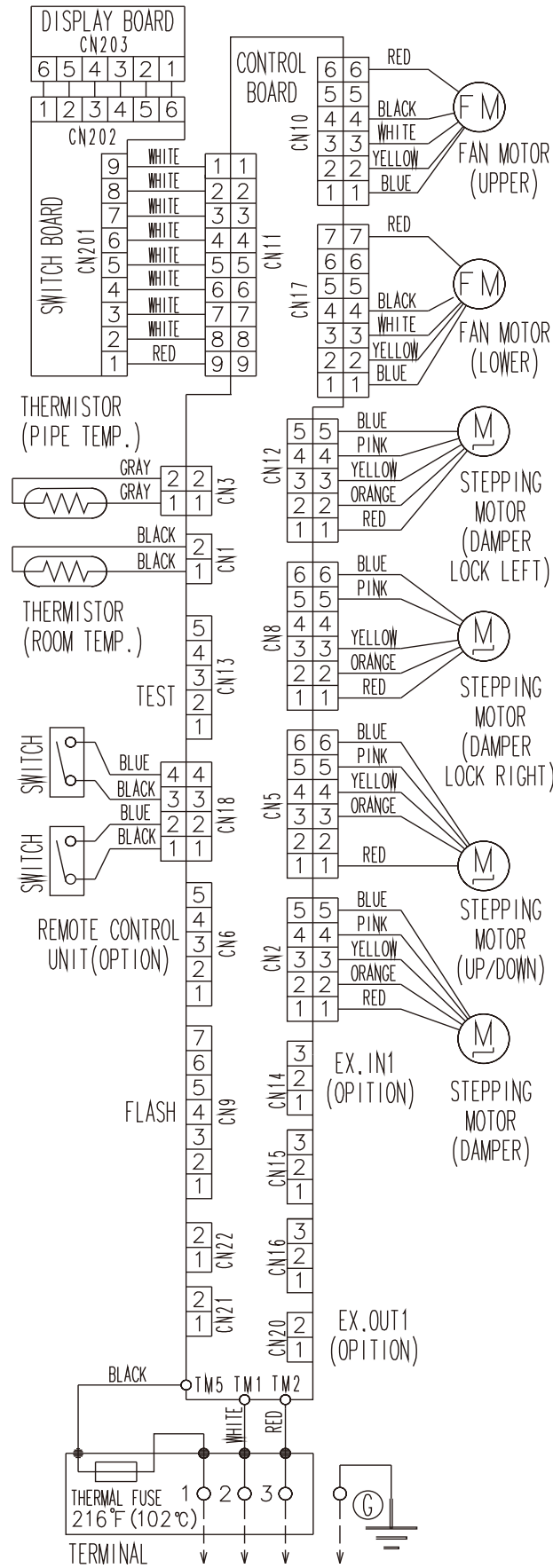

6. Air velocity and temperature distributions

6-1. Compact cassette type

■ Models: AUU7RLF and AUU9RLF

- Air velocity distribution

Measuring conditions	Fan speed	Operation mode
	HIGH	FAN

Top view
Vertical airflow direction louver: Up

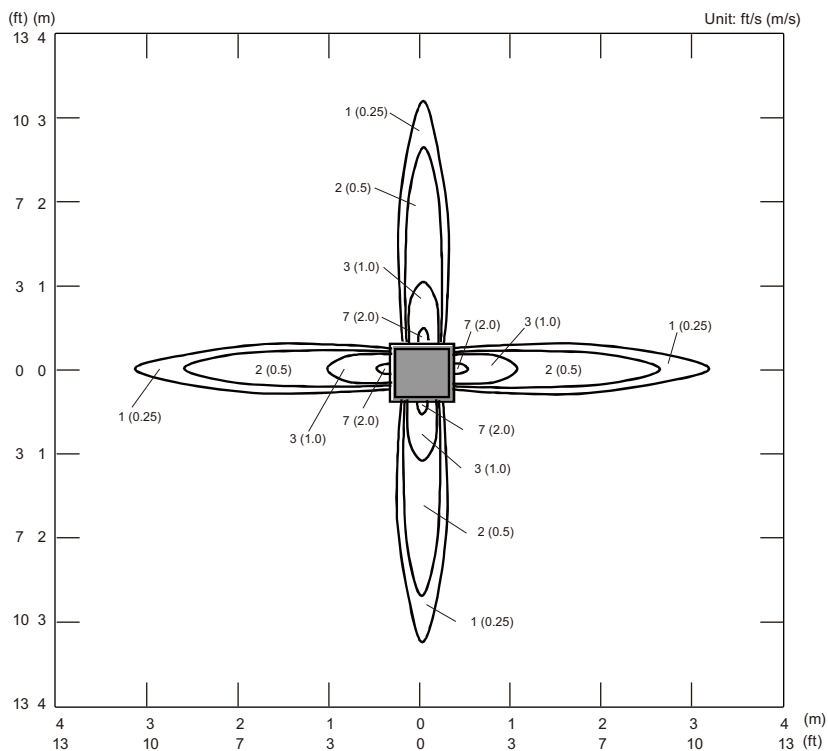

Side view
Vertical airflow direction louver: Up

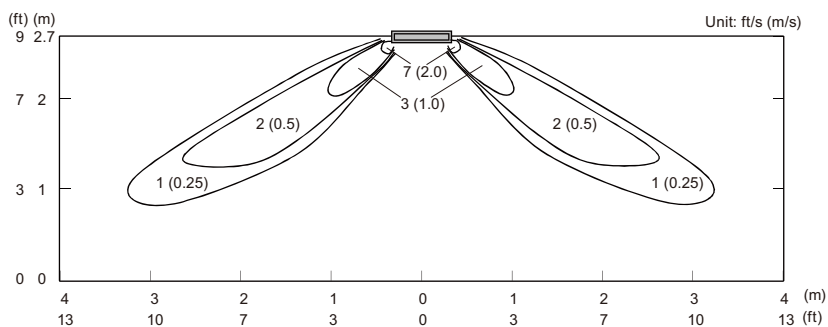

Measuring conditions NOTE: Reference data	Fan speed	Operation mode	Outlet directions
	HIGH	HEAT	4-way air outlet

• Air velocity distribution

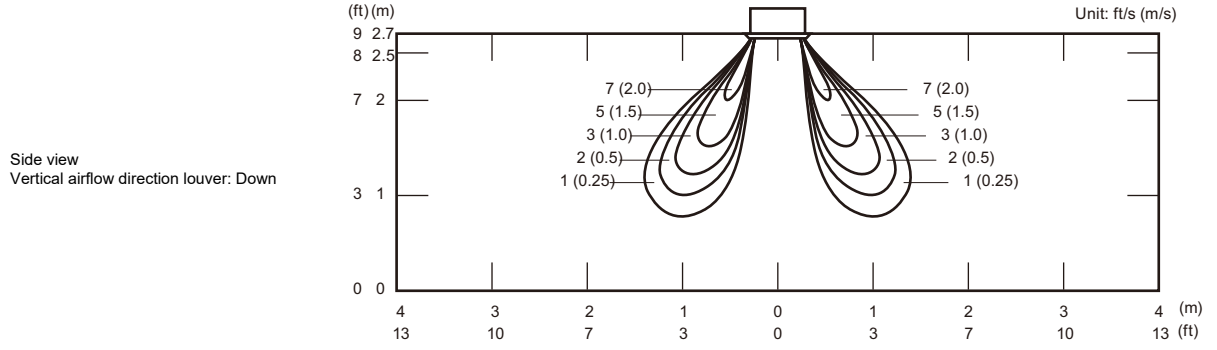

• Air temperature distribution

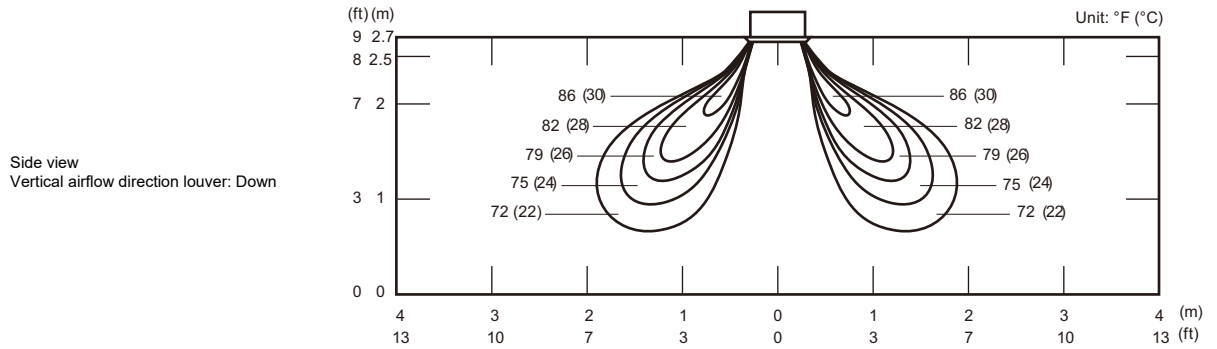

Model: AUU12RLF

- Air velocity distribution

Measuring conditions	Fan speed	Operation mode
	HIGH	FAN

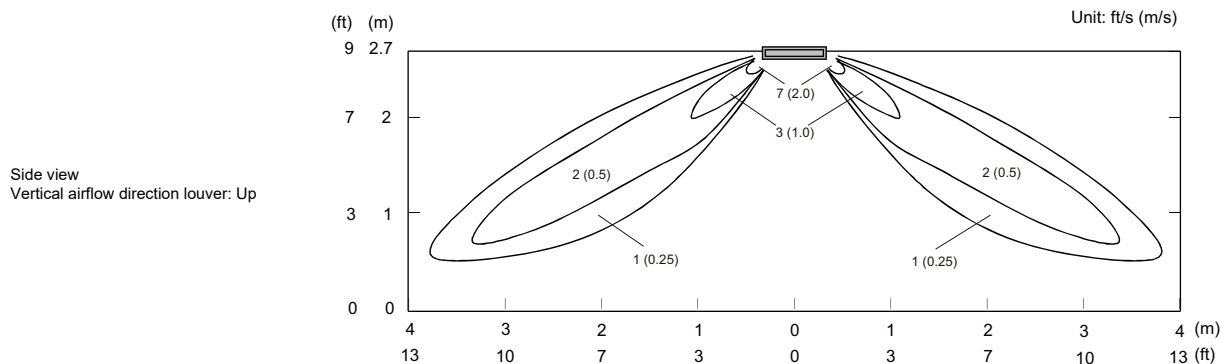
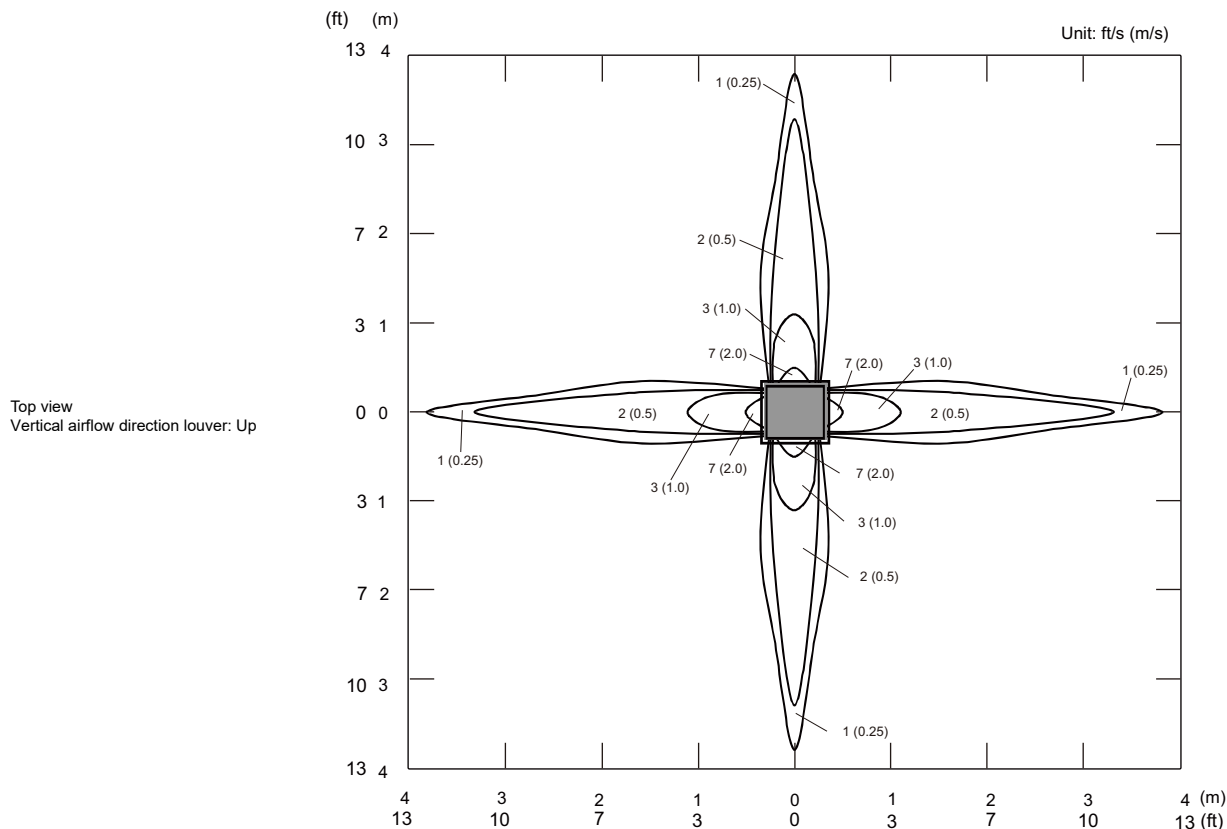

Measuring conditions NOTE: Reference data	Fan speed HIGH	Operation mode HEAT	Outlet directions 4-way air outlet
----------------------------------------------	-------------------	------------------------	---------------------------------------

• Air velocity distribution

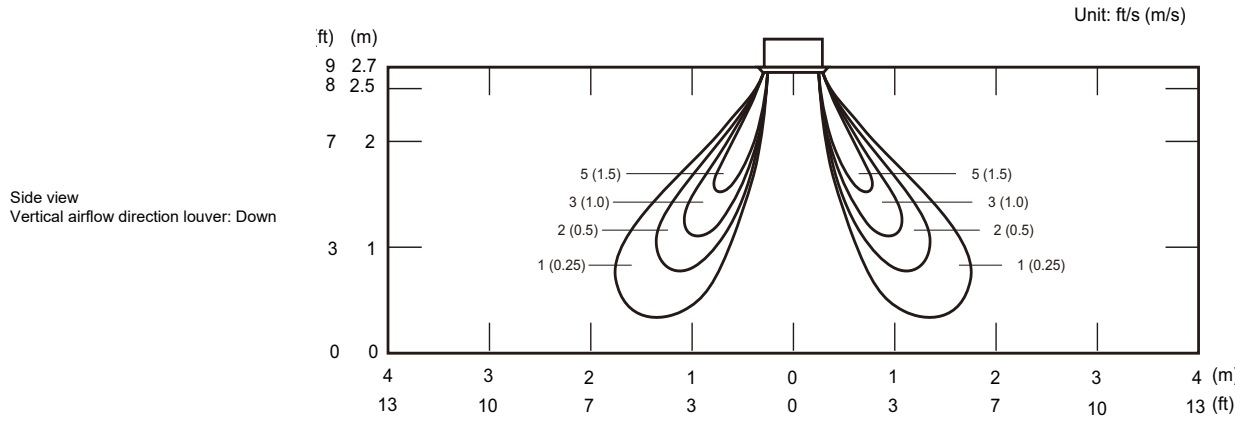

• Air temperature distribution

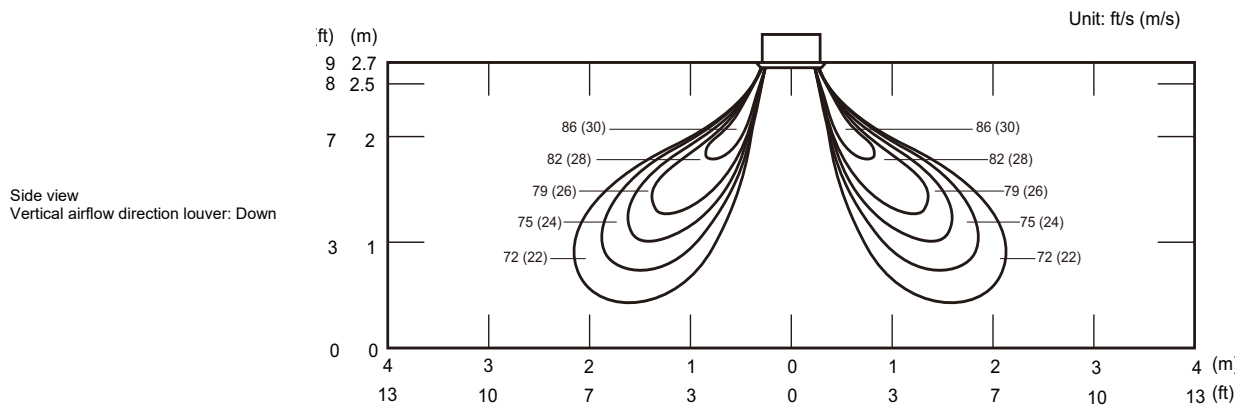

Model: AUU18RLF

- Air velocity distribution

Measuring conditions	Fan speed	Operation mode
	HIGH	FAN

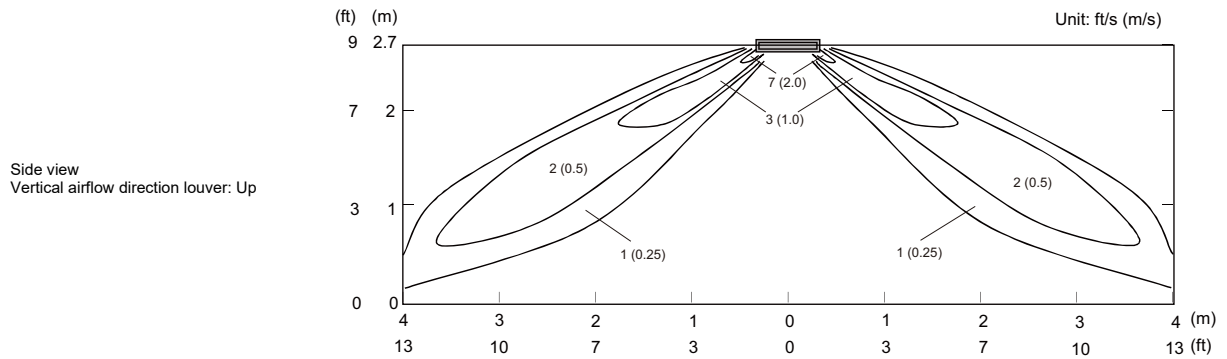
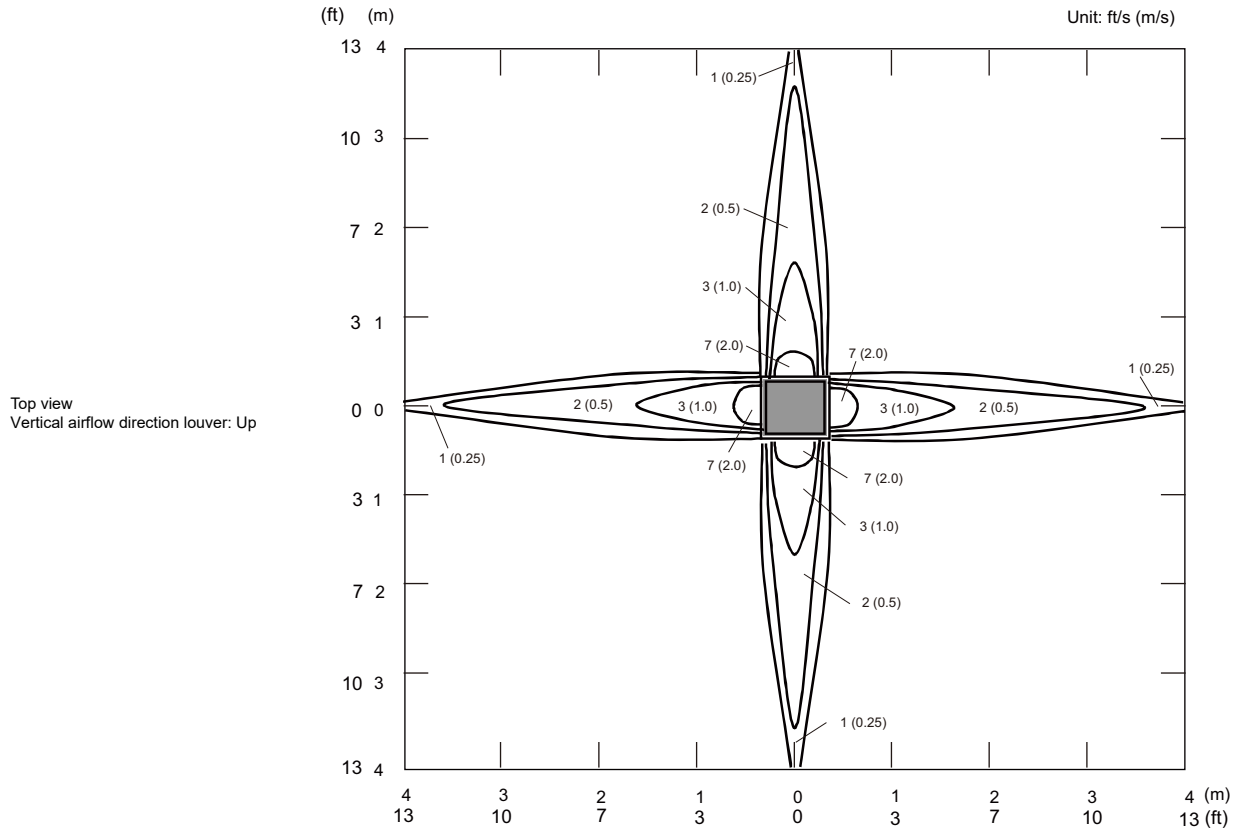

Measuring conditions NOTE: Reference data	Fan speed	Operation mode	Outlet directions
	HIGH	HEAT	4-way air outlet

• Air velocity distribution

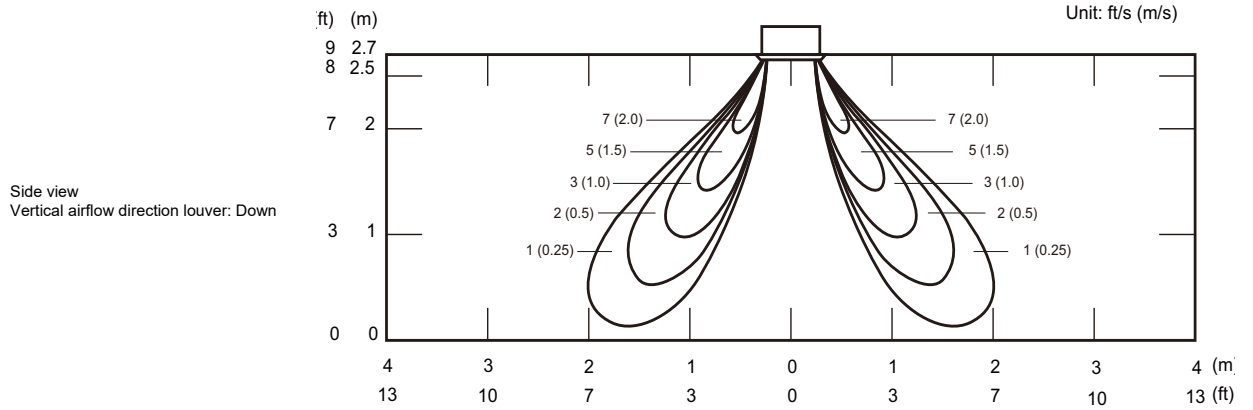

• Air temperature distribution

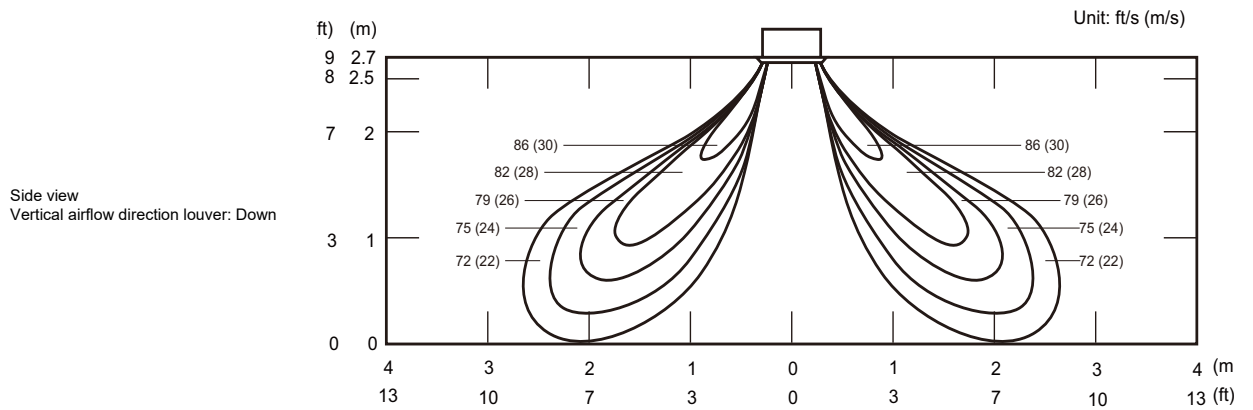

6-2. Slim duct type

Model: ARU7RLF

NOTE: This data is measured after installing optional Auto louver grille kit.

Measuring conditions	Fan speed	Operation mode
	HIGH	FAN

- Air velocity distribution

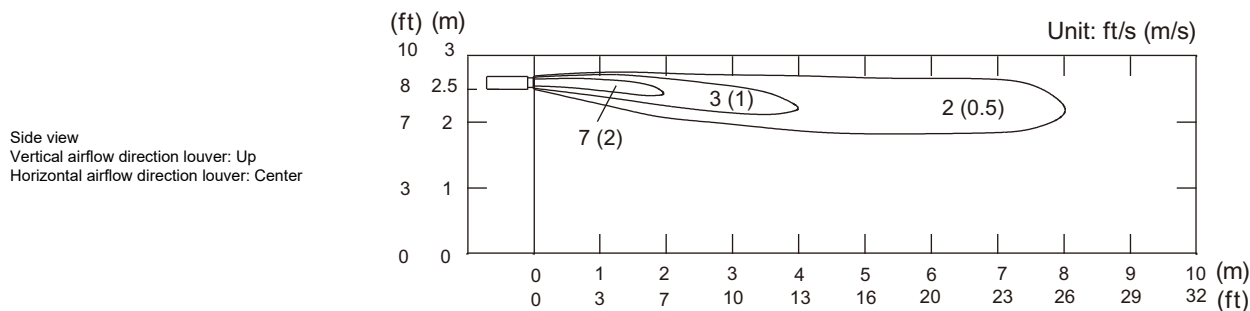
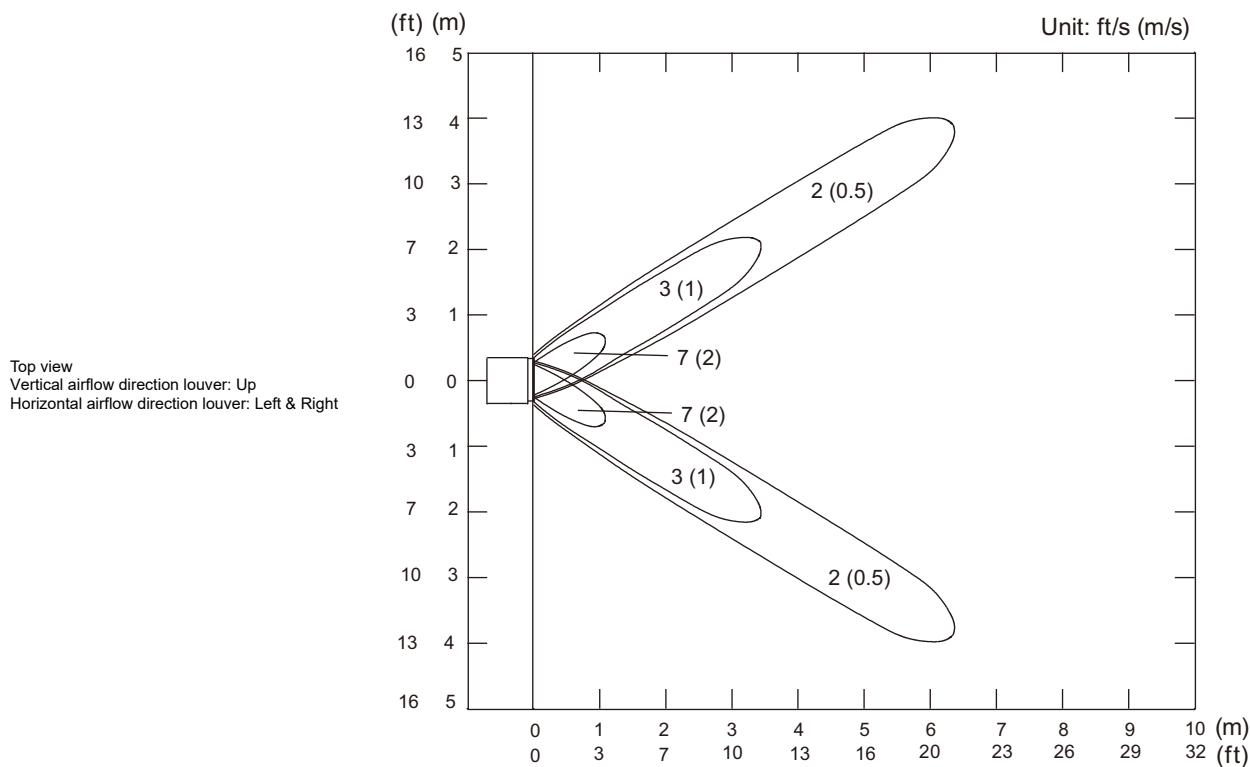
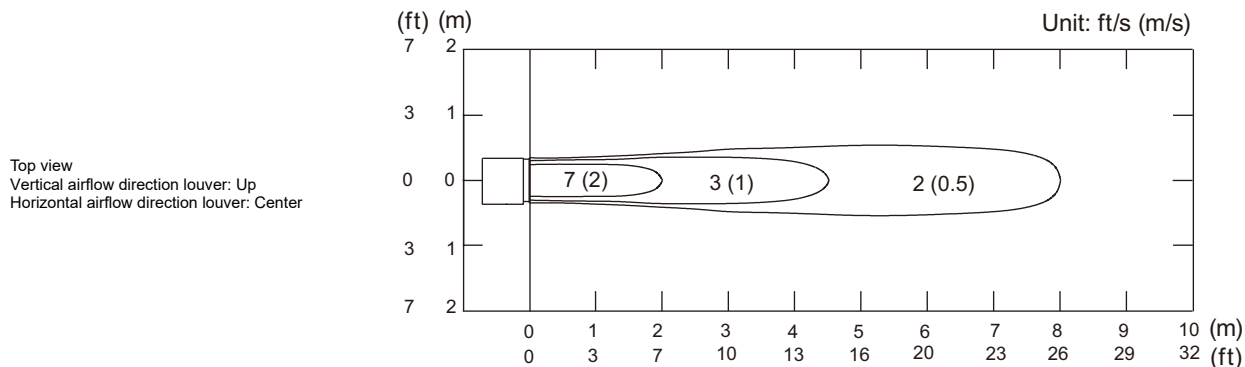

Measuring conditions	Fan speed	Operation mode
	HIGH	HEAT

• Air velocity distribution

Side view
Vertical airflow direction louver: Down
Horizontal airflow direction louver: Center

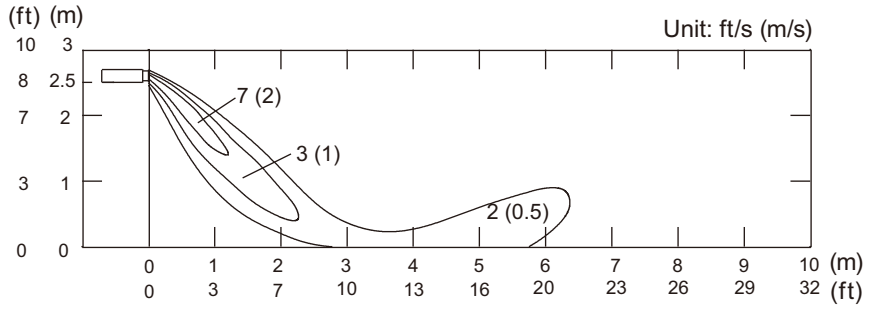

• Air temperature distribution

Side view
Vertical airflow direction louver: Down
Horizontal airflow direction louver: Center

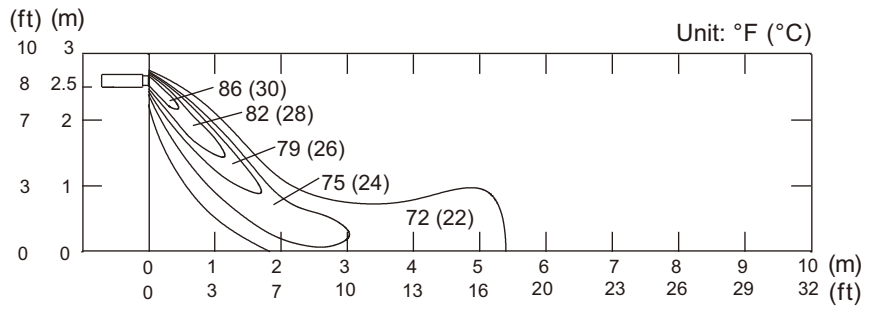

Model: ARU9RLF

NOTE: This data is measured after installing optional Auto louver grille kit.

Measuring conditions	Fan speed	Operation mode
	HIGH	FAN

- Air velocity distribution

Top view
Vertical airflow direction louver: Up
Horizontal airflow direction louver: Center

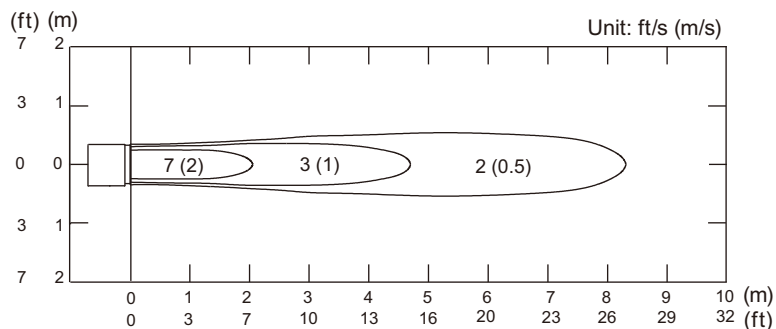

Top view
Vertical airflow direction louver: Up
Horizontal airflow direction louver: Left & Right

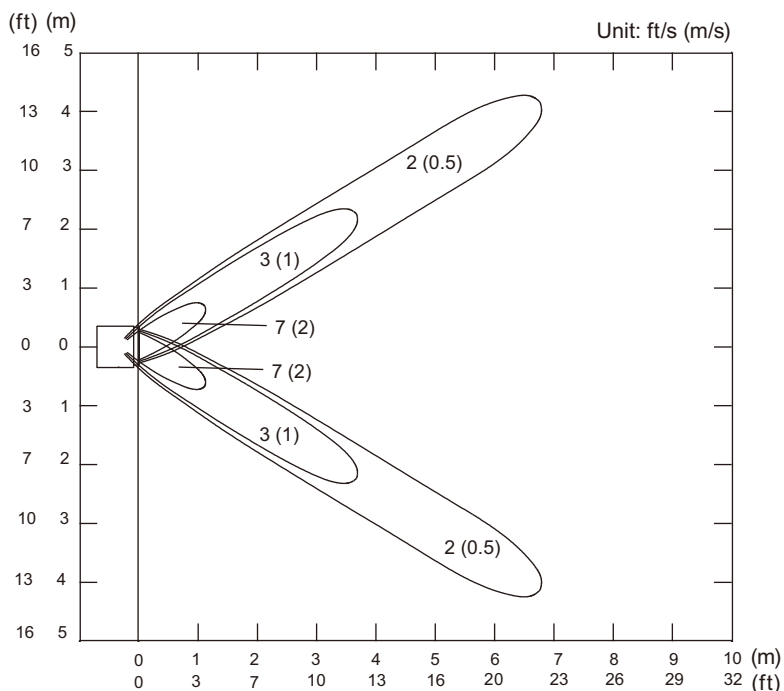

Side view
Vertical airflow direction louver: Up
Horizontal airflow direction louver: Center

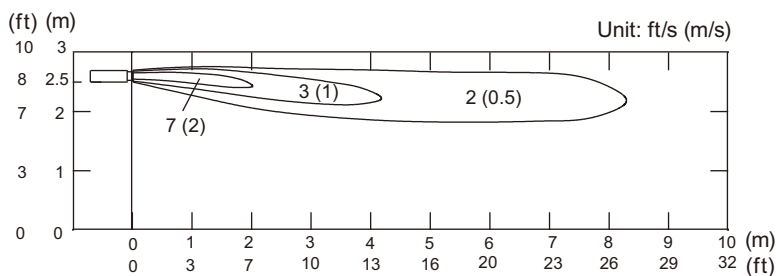

Measuring conditions	Fan speed	Operation mode
	HIGH	HEAT

• Air velocity distribution

Side view
Vertical airflow direction louver: Down
Horizontal airflow direction louver: Center

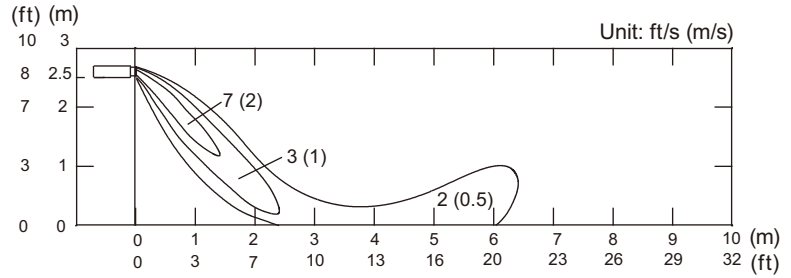

• Air temperature distribution

Side view
Vertical airflow direction louver: Down
Horizontal airflow direction louver: Center

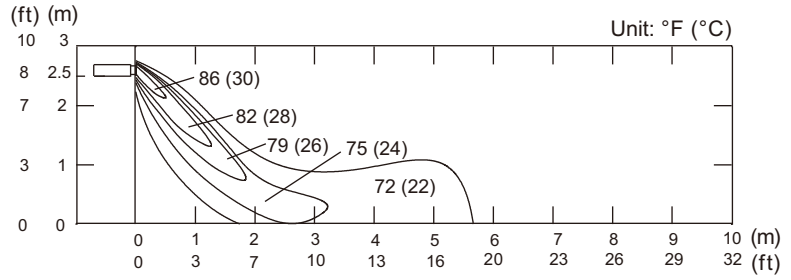

Model: ARU12RLF

NOTE: This data is measured after installing optional Auto louver grille kit.

Measuring conditions	Fan speed	Operation mode
	HIGH	FAN

- Air velocity distribution

Top view
Vertical airflow direction louver: Up
Horizontal airflow direction louver: Center

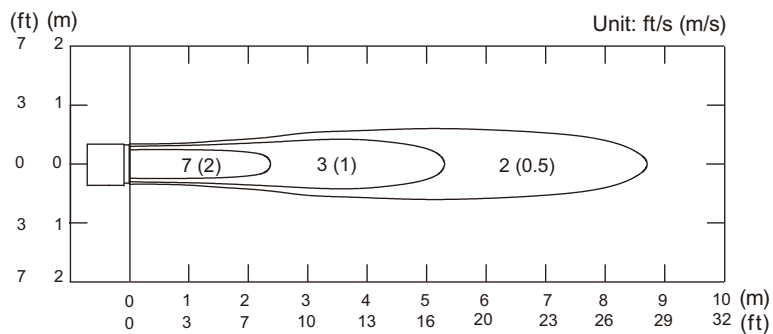

Top view
Vertical airflow direction louver: Up
Horizontal airflow direction louver: Left & Right

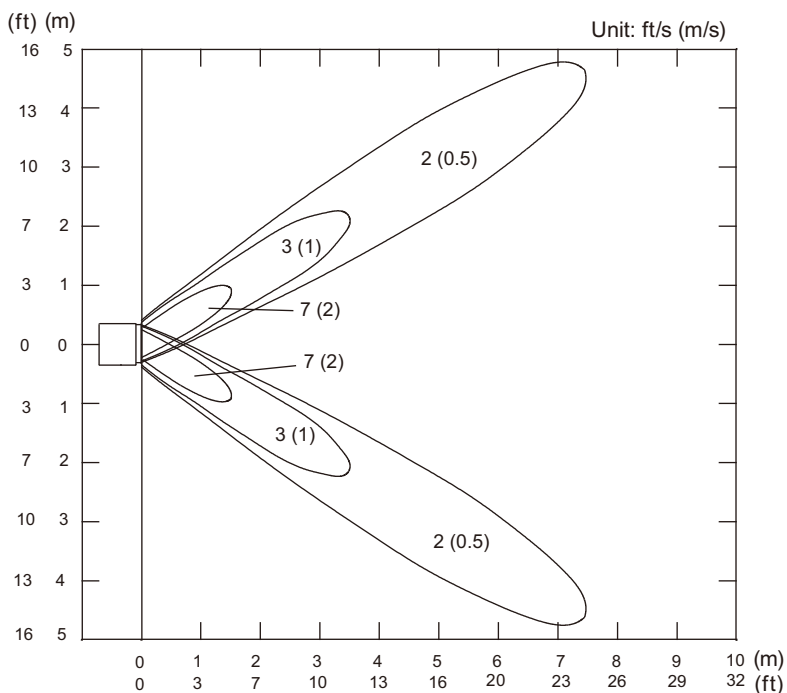

Side view
Vertical airflow direction louver: Up
Horizontal airflow direction louver: Center

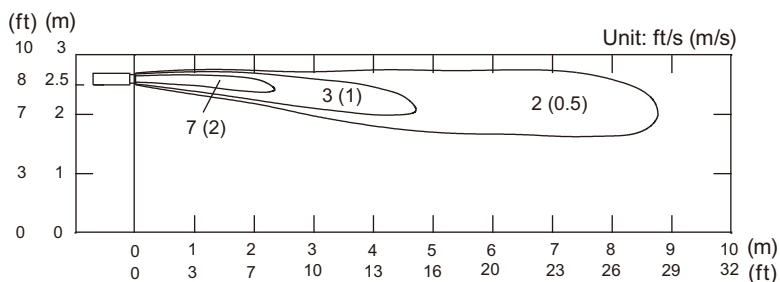

Measuring conditions	Fan speed	Operation mode
	HIGH	HEAT

• Air velocity distribution

Side view
Vertical airflow direction louver: Down
Horizontal airflow direction louver: Center

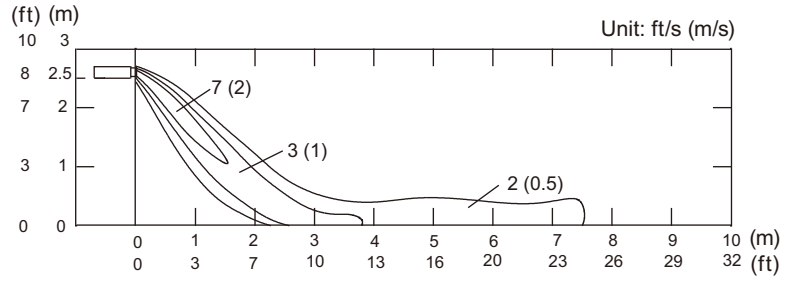

• Air temperature distribution

Side view
Vertical airflow direction louver: Down
Horizontal airflow direction louver: Center

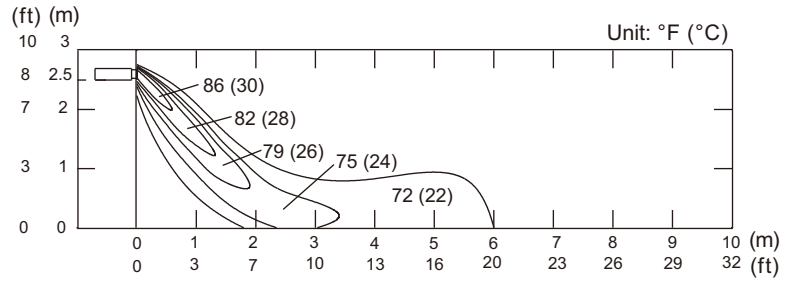

Model: ARU18RLF

NOTE: This data is measured after installing optional Auto louver grille kit.

Measuring conditions	Fan speed	Operation mode
	HIGH	FAN

- Air velocity distribution

Top view
Vertical airflow direction louver: Up
Horizontal airflow direction louver: Center

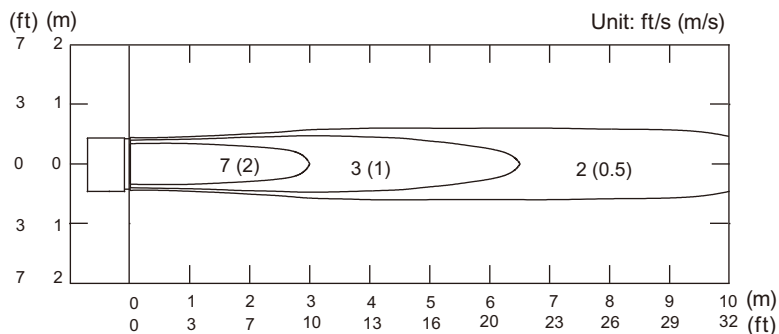

Top view
Vertical airflow direction louver: Up
Horizontal airflow direction louver: Left & Right

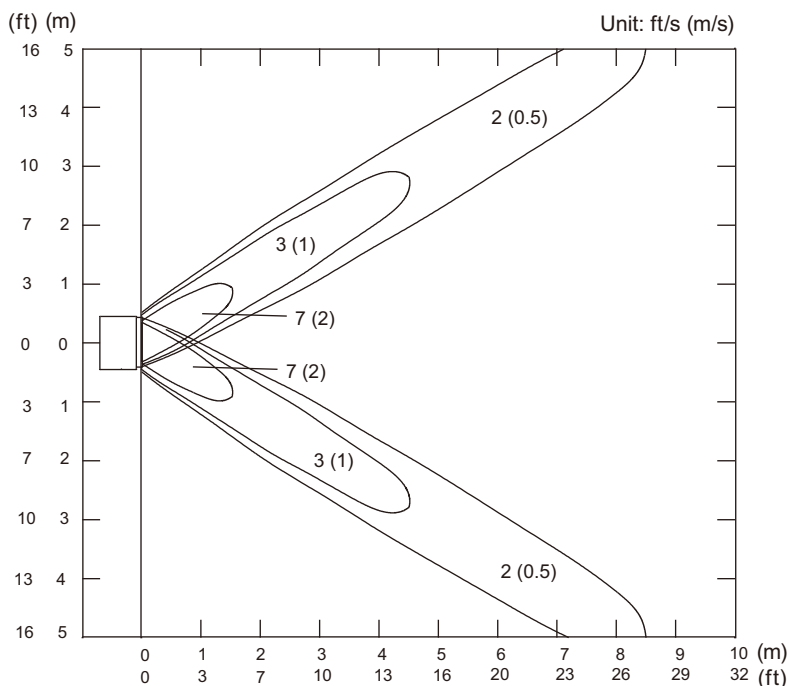

Side view
Vertical airflow direction louver: Up
Horizontal airflow direction louver: Center

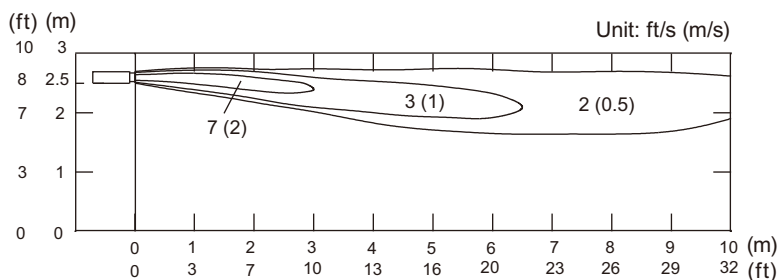

Measuring conditions	Fan speed	Operation mode
	HIGH	HEAT

• Air velocity distribution

Side view
Vertical airflow direction louver: Down
Horizontal airflow direction louver: Center

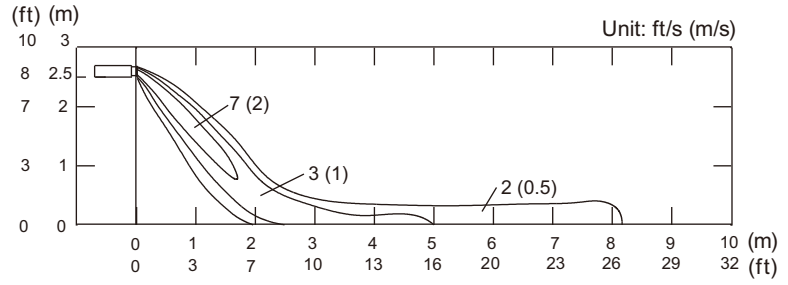

• Air temperature distribution

Side view
Vertical airflow direction louver: Down
Horizontal airflow direction louver: Center

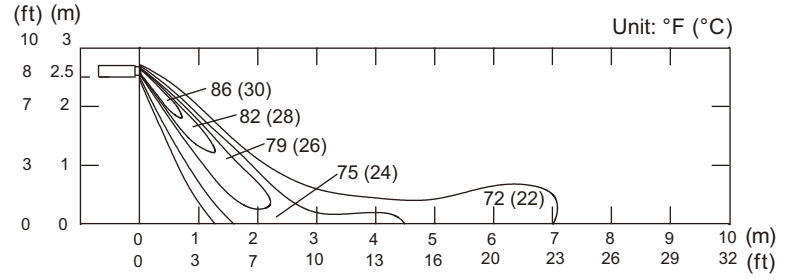

Model: ARU24RLF

NOTE: This data is measured after installing optional Auto louver grille kit.

Measuring conditions	Fan speed	Operation mode
	HIGH	FAN

- Air velocity distribution

Top view
Vertical airflow direction louver: Up
Horizontal airflow direction louver: Center

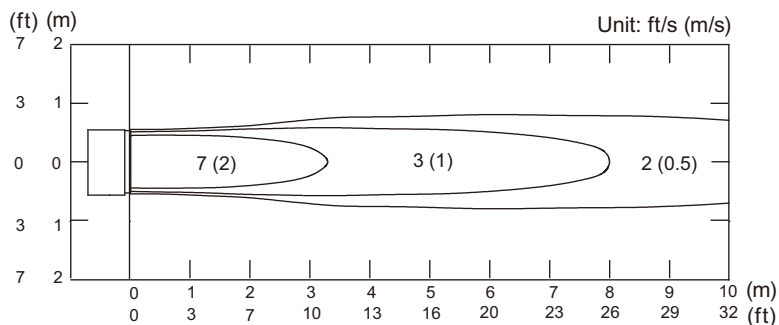

Top view
Vertical airflow direction louver: Up
Horizontal airflow direction louver: Left & Right

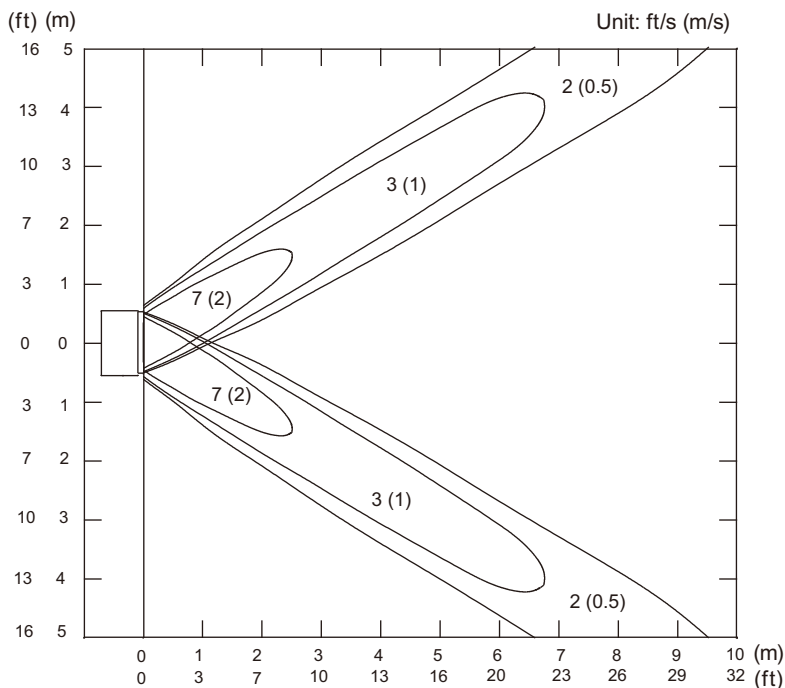

Side view
Vertical airflow direction louver: Up
Horizontal airflow direction louver: Center

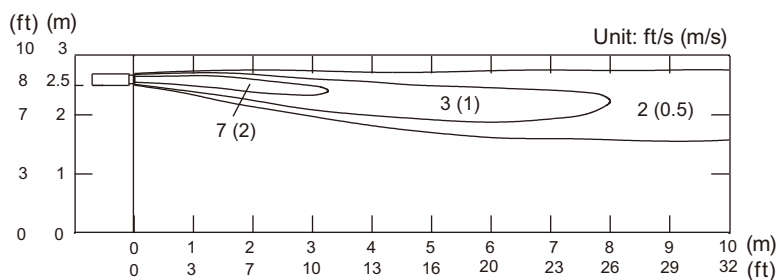

Measuring conditions	Fan speed	Operation mode
	HIGH	HEAT

• Air velocity distribution

Side view
Vertical airflow direction louver: Down
Horizontal airflow direction louver: Center

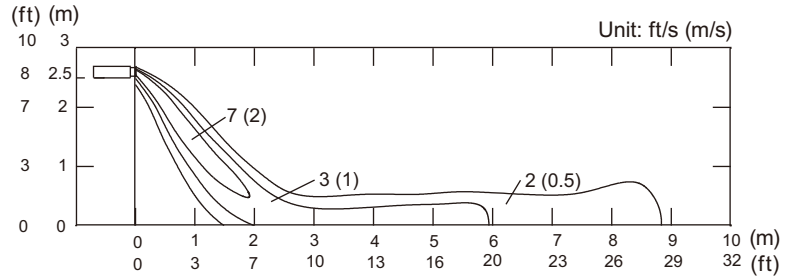

• Air temperature distribution

Side view
Vertical airflow direction louver: Down
Horizontal airflow direction louver: Center

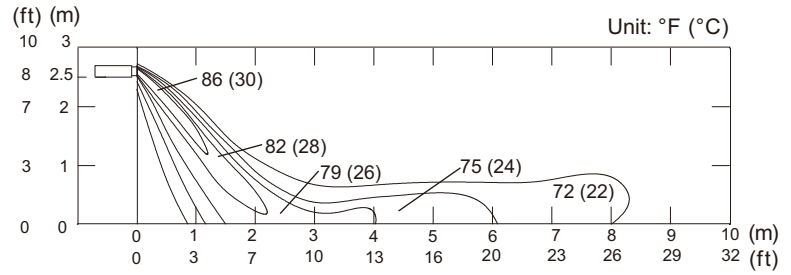

6-3. Wall mounted type

Model: ASU7RLF1

Measuring conditions	Fan speed	Operation mode
	HIGH	FAN

Top view
Vertical airflow direction louver: Up
Horizontal airflow direction louver: Center

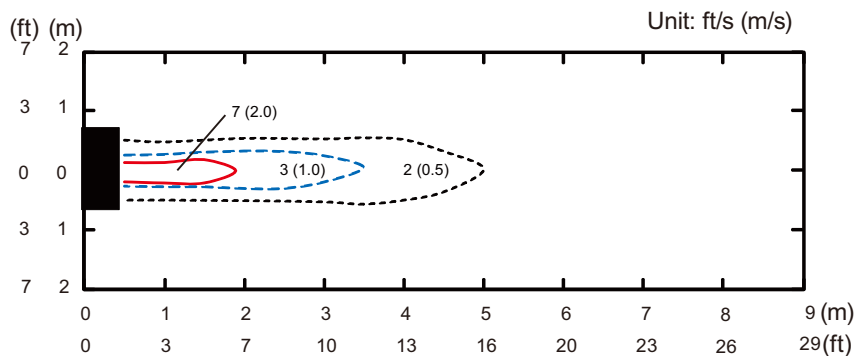

Top view
Vertical airflow direction louver: Up
Horizontal airflow direction louver: Left & Right

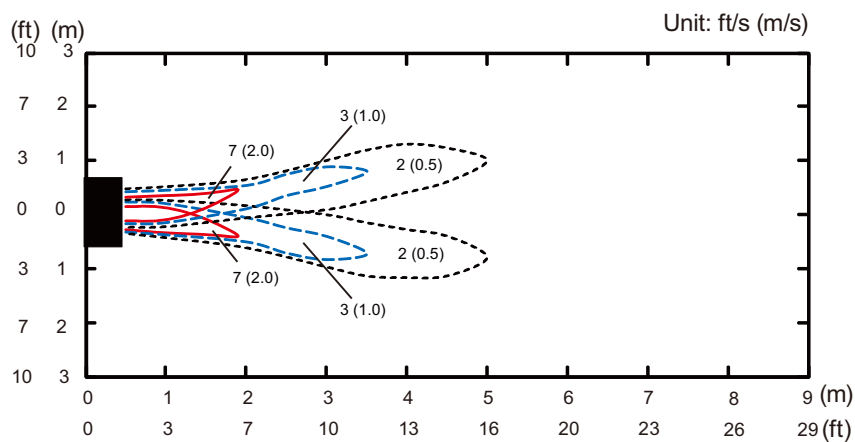

Side view
Vertical airflow direction louver: Up
Horizontal airflow direction louver: Center

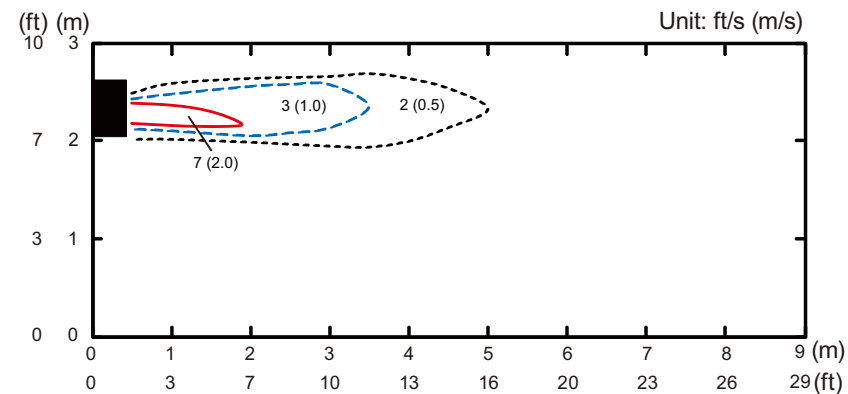

Side view
Vertical airflow direction louver: Down
Horizontal airflow direction louver: Center

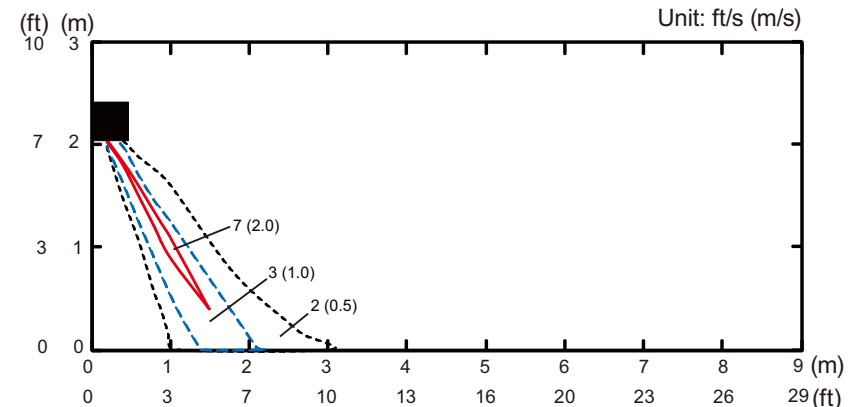

Model: ASU9RLF1

Measuring conditions	Fan speed	Operation mode
	HIGH	FAN

Top view
Vertical airflow direction louver: Up
Horizontal airflow direction louver: Center

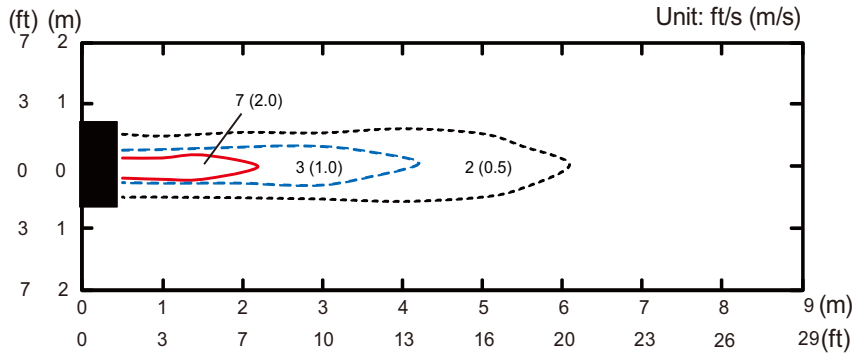

Top view
Vertical airflow direction louver: Up
Horizontal airflow direction louver: Left & Right

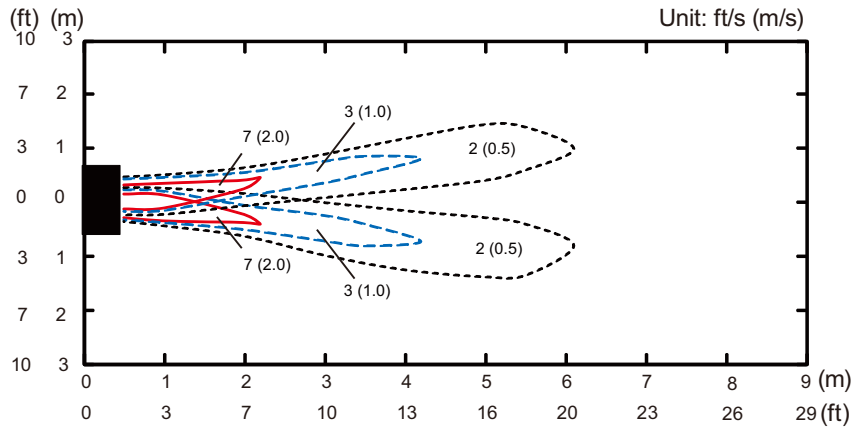

Side view
Vertical airflow direction louver: Up
Horizontal airflow direction louver: Center

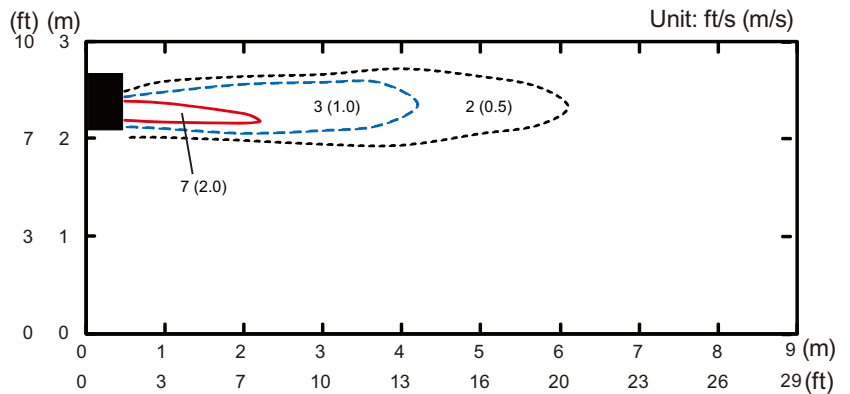

Side view
Vertical airflow direction louver: Down
Horizontal airflow direction louver: Center

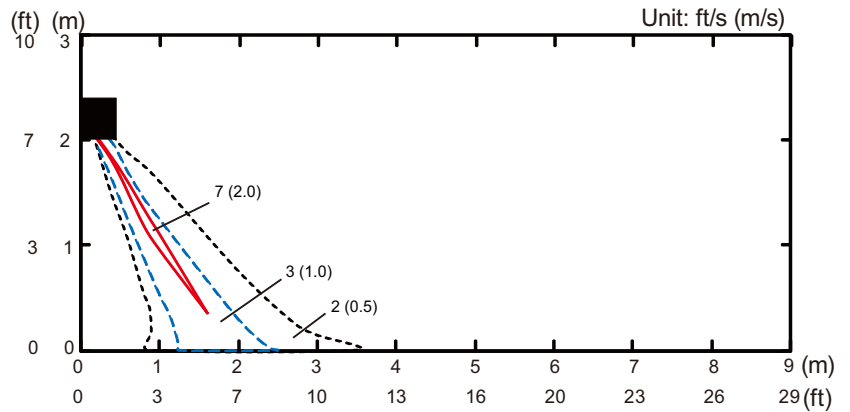

Model: ASU12RLF1

Measuring conditions	Fan speed	Operation mode
	HIGH	FAN

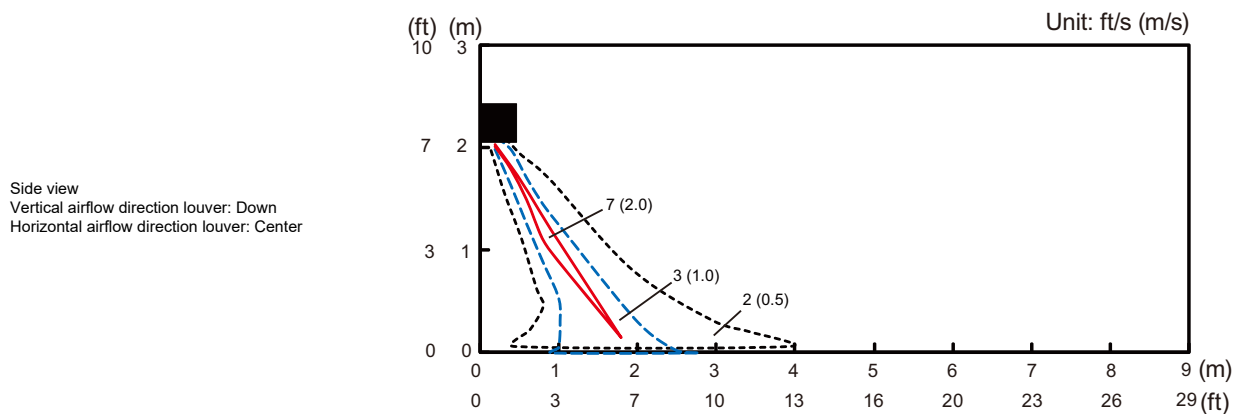
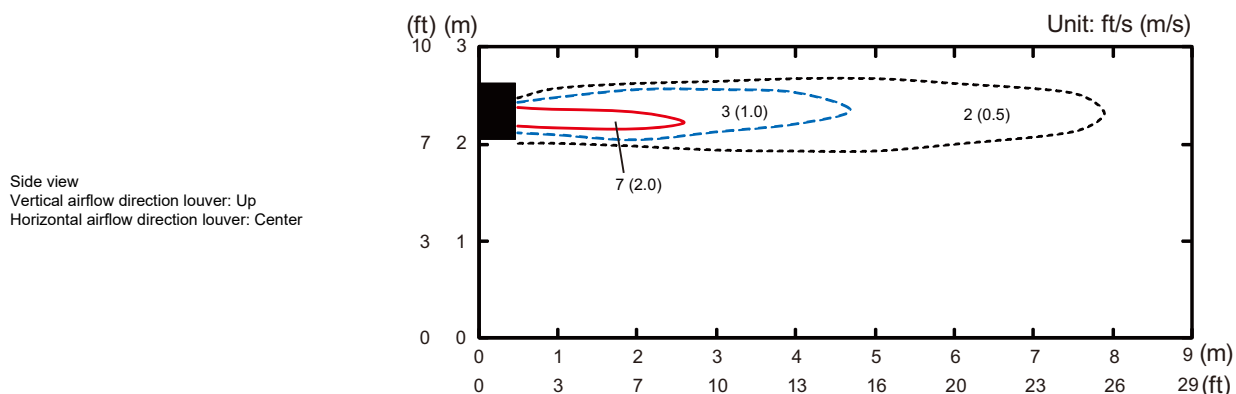
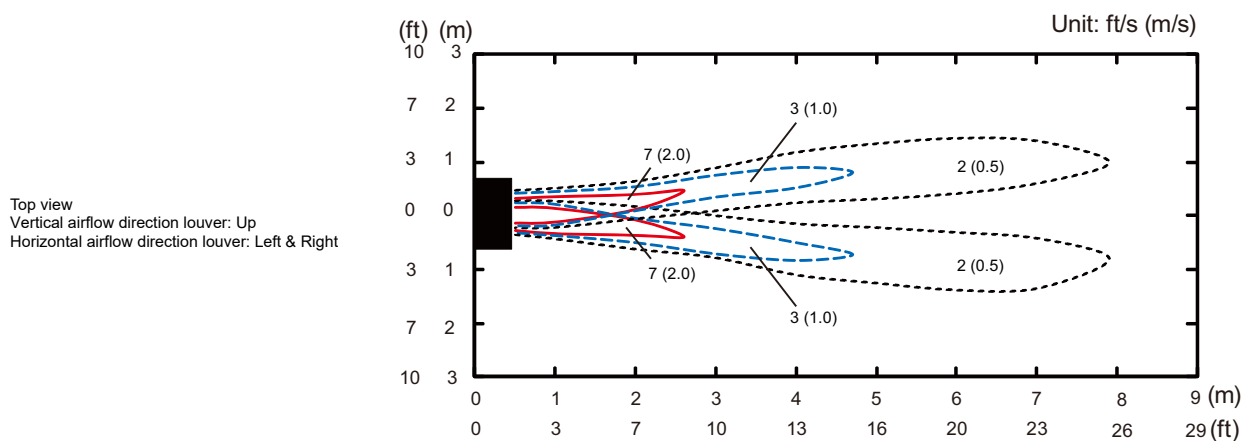
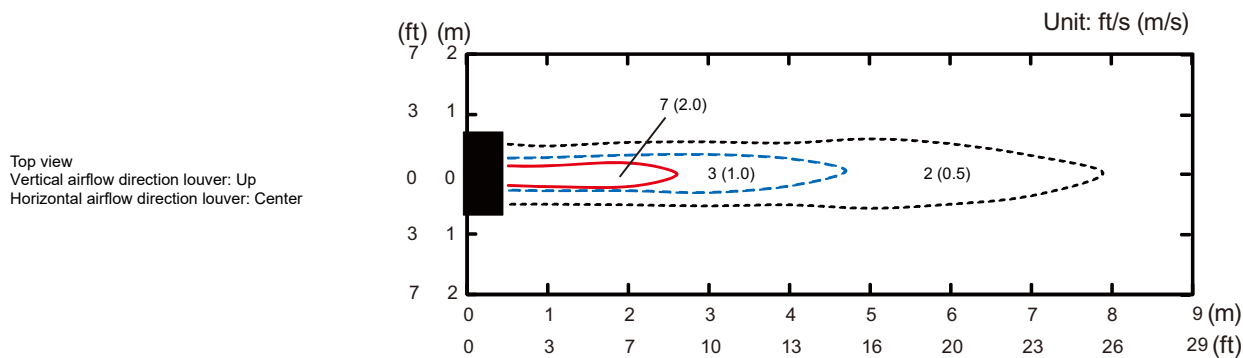

Model: ASU15RLF1

Measuring conditions	Fan speed	Operation mode
	HIGH	FAN

Top view
Vertical airflow direction louver: Up
Horizontal airflow direction louver: Center

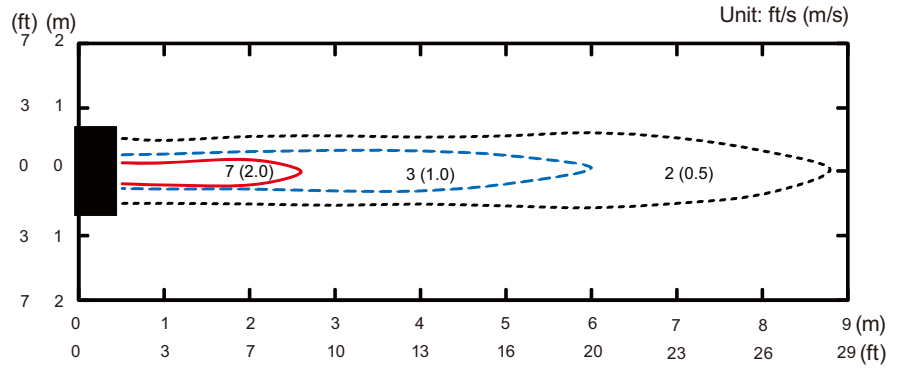

Top view
Vertical airflow direction louver: Up
Horizontal airflow direction louver: Left & Right

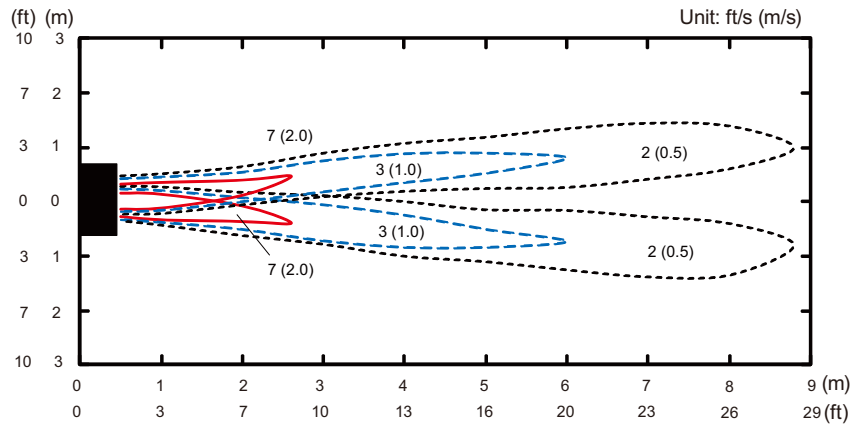

Side view
Vertical airflow direction louver: Up
Horizontal airflow direction louver: Center

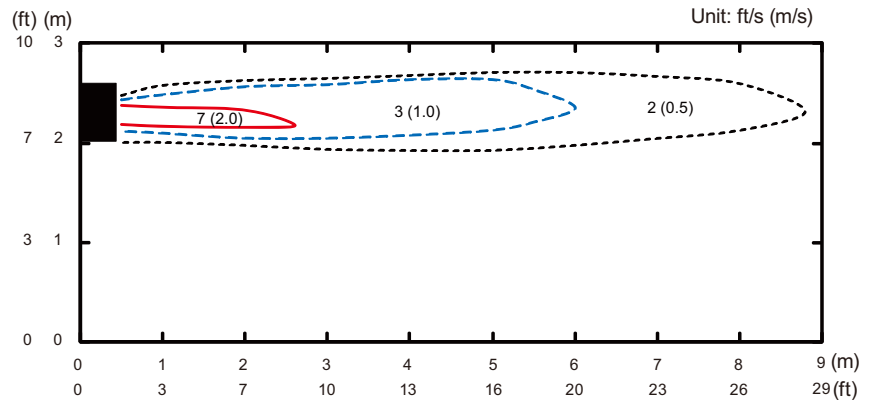

Side view
Vertical airflow direction louver: Down
Horizontal airflow direction louver: Center

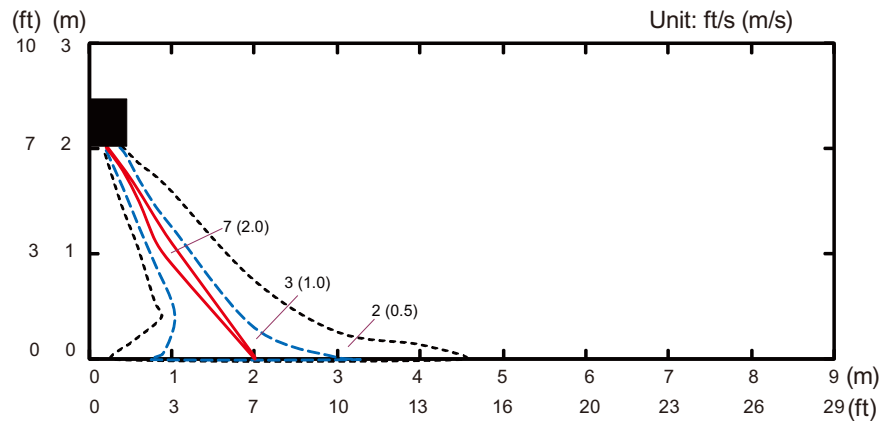

Model: ASU18RLF

Measuring conditions	Fan speed	Operation mode
	HIGH	FAN

Top view
Vertical airflow direction louver: Up
Horizontal airflow direction louver: Center

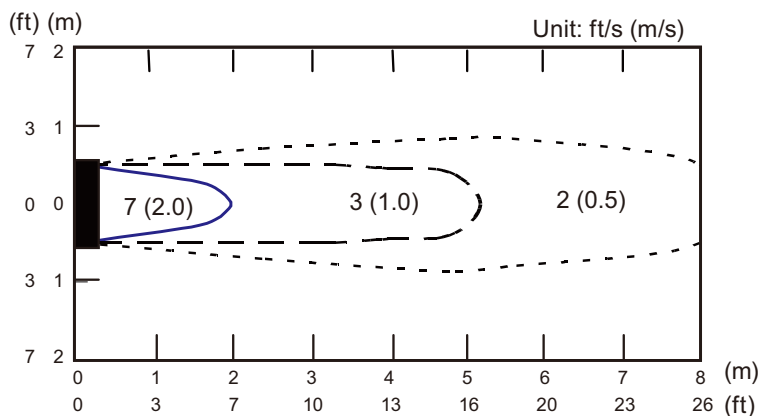

Top view
Vertical airflow direction louver: Up
Horizontal airflow direction louver: Left & Right

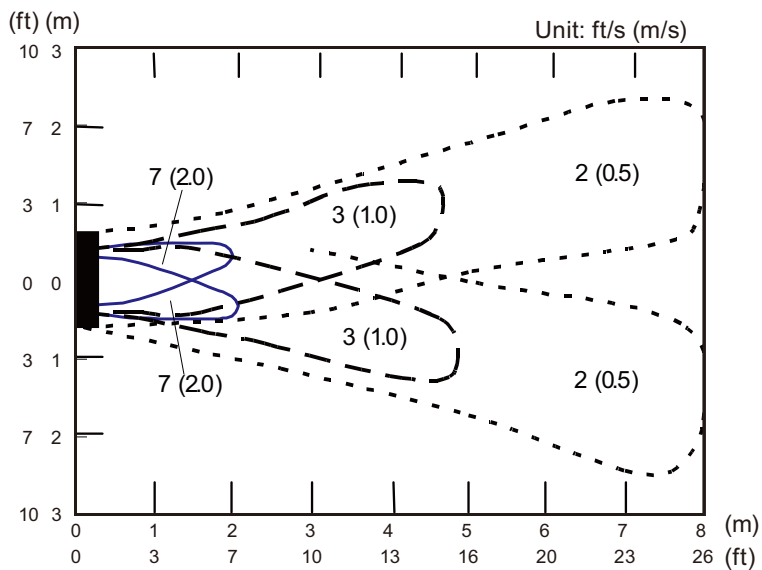

Side view
Vertical airflow direction louver: Up
Horizontal airflow direction louver: Center

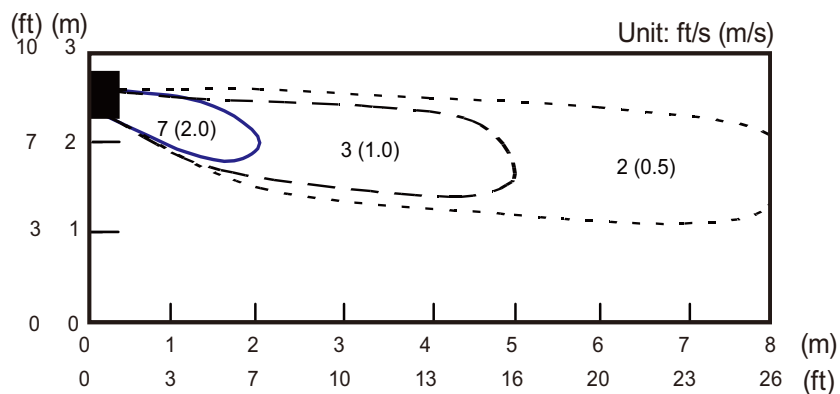

Side view
Vertical airflow direction louver: Down
Horizontal airflow direction louver: Center

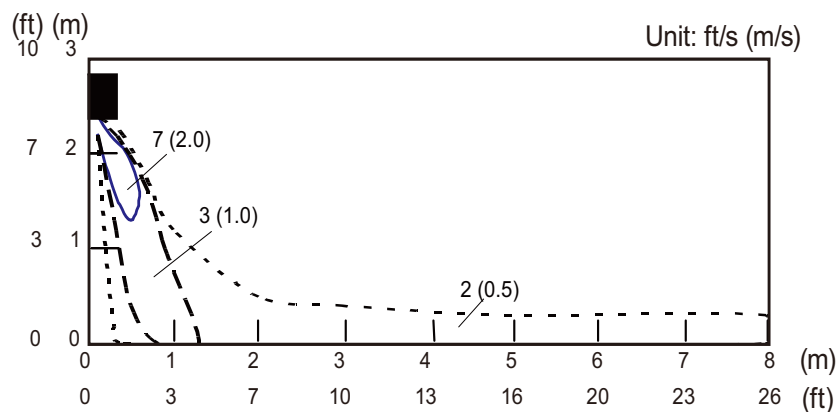

Model: ASU24RLF

Measuring conditions	Fan speed	Operation mode
	HIGH	FAN

Top view
Vertical airflow direction louver: Up
Horizontal airflow direction louver: Center

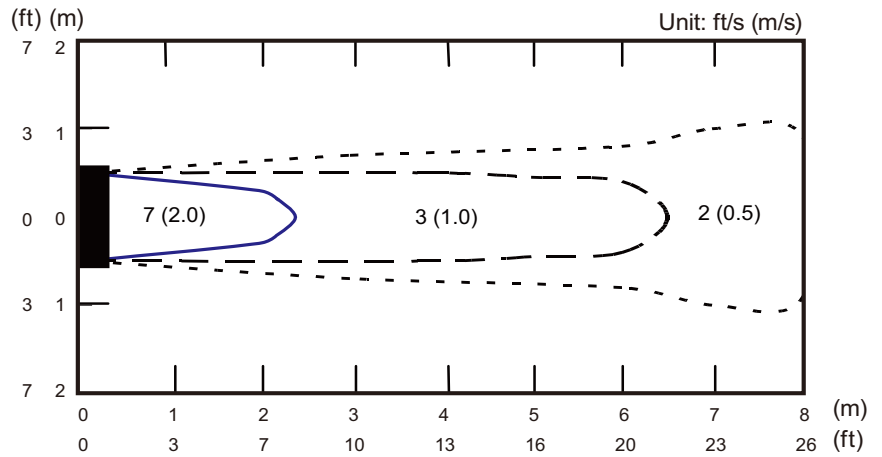

Top view
Vertical airflow direction louver: Up
Horizontal airflow direction louver: Left & Right

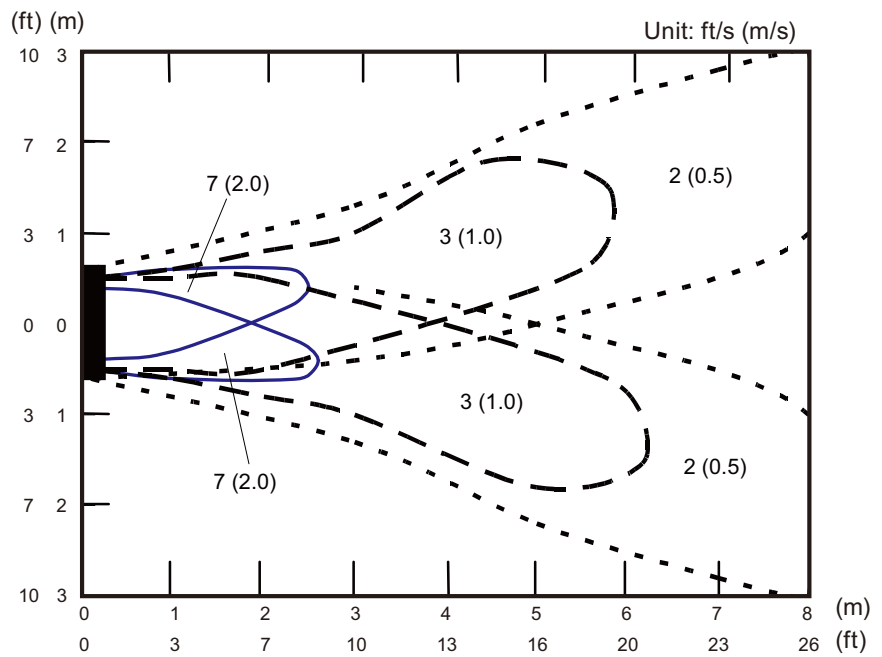

Side view
Vertical airflow direction louver: Up
Horizontal airflow direction louver: Center

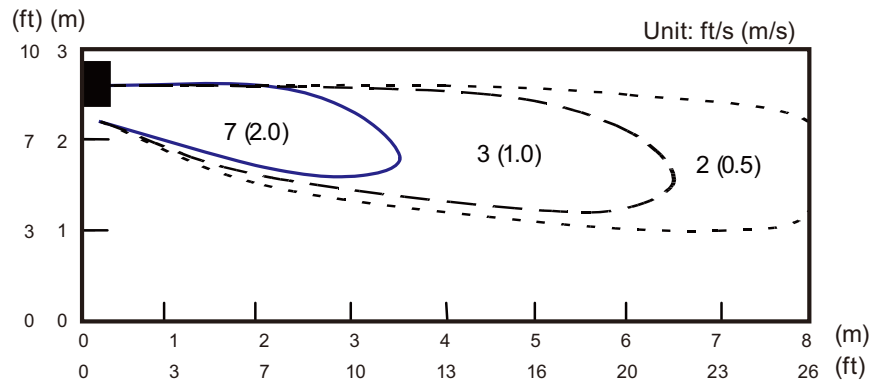

Side view
Vertical airflow direction louver: Down
Horizontal airflow direction louver: Center

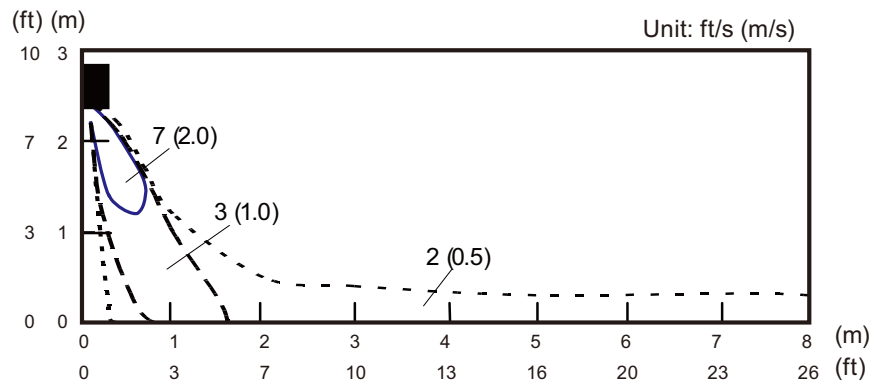

6-4. Floor type

Models: AGU9RLF, AGU12RLF, and AGU15RLF

Measuring conditions	Fan speed	Operation mode	Fan select
	HIGH	FAN	Upper and lower

Top view
Vertical airflow direction louver: Up
Horizontal airflow direction louver: Center

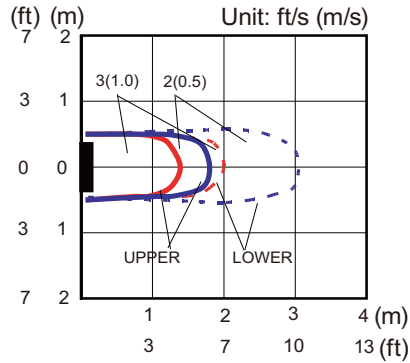

Top view
Vertical airflow direction louver: Up
Horizontal airflow direction louver: Left & Right

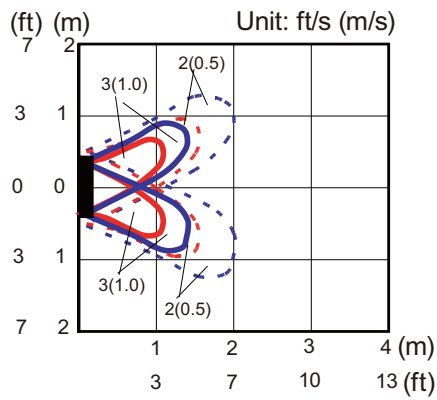

Side view
Vertical airflow direction louver: Up
Horizontal airflow direction louver: Center

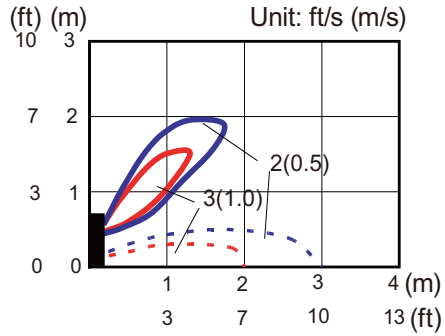

Side view
Vertical airflow direction louver: Down
Horizontal airflow direction louver: Center

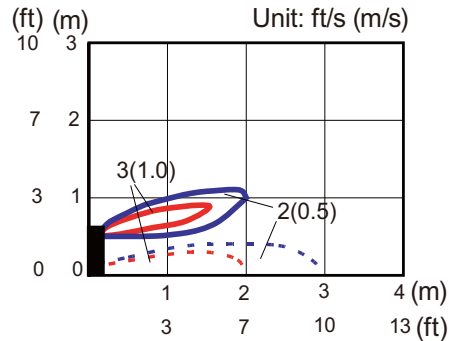

7. Fan performance

7-1. Slim duct type

Model: ARU7RLF

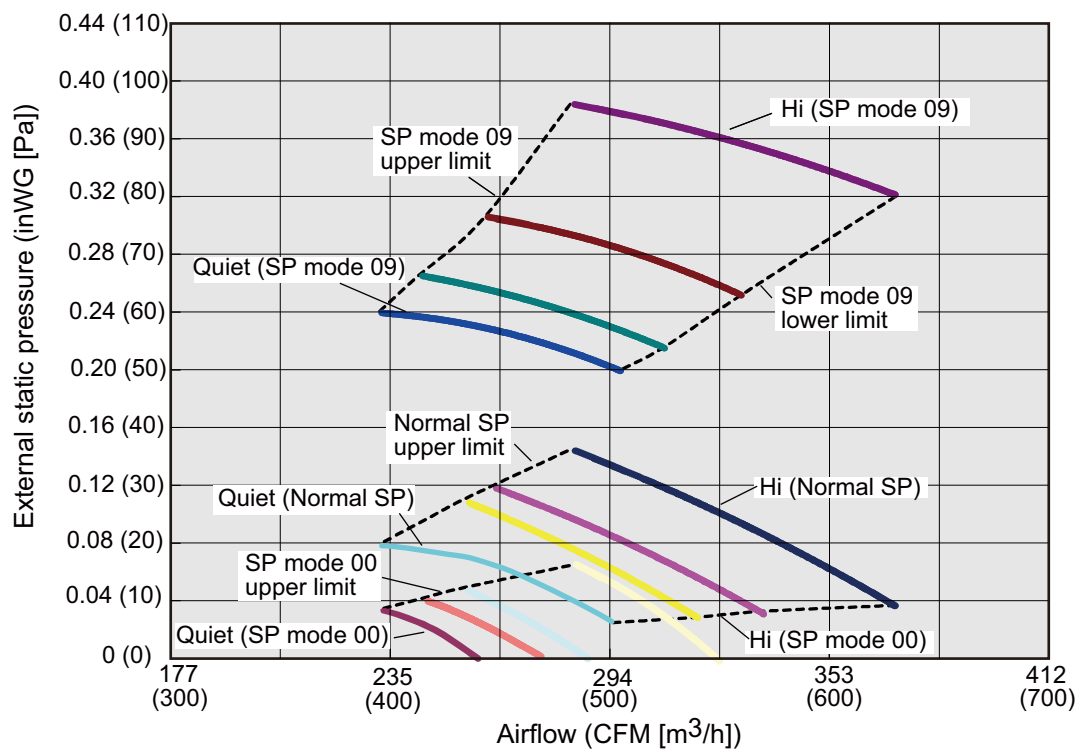

Available airflow rate range (High level)

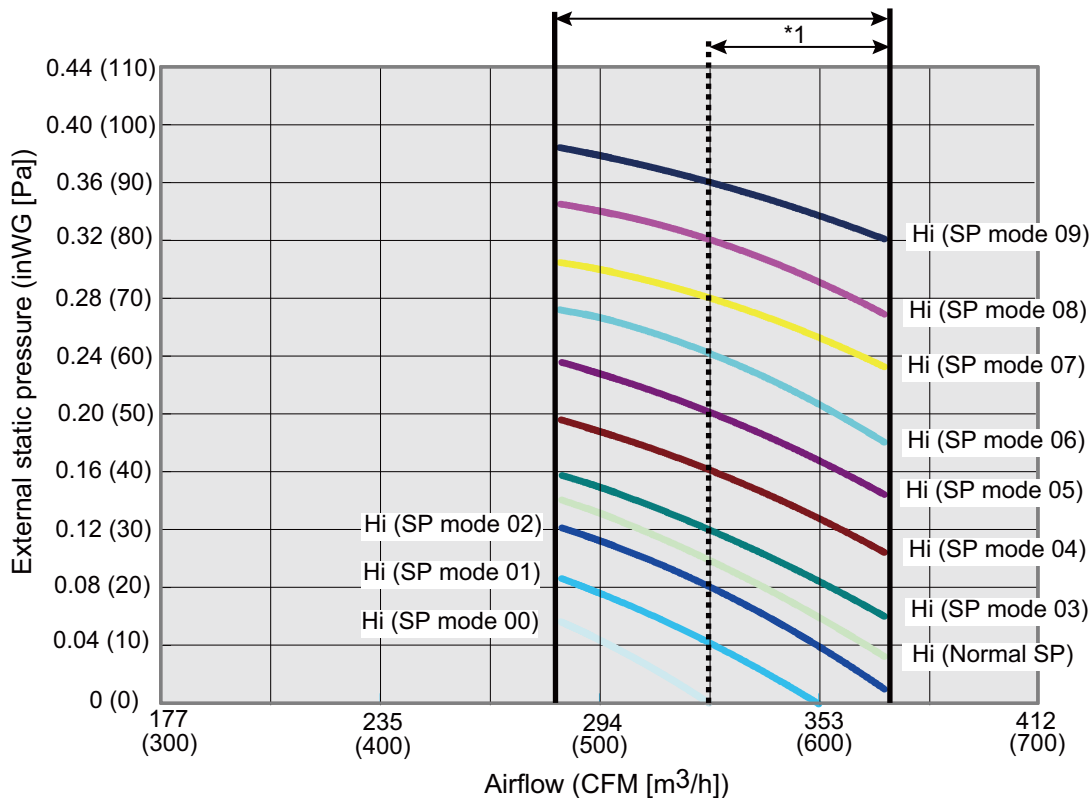

*1: Available airflow rate range when Auto louver grille (option) is installed.
 Fan speed : HIGH
 Vertical airflow direction louver : Up

● Characteristics of air volume and capacity

• Cooling

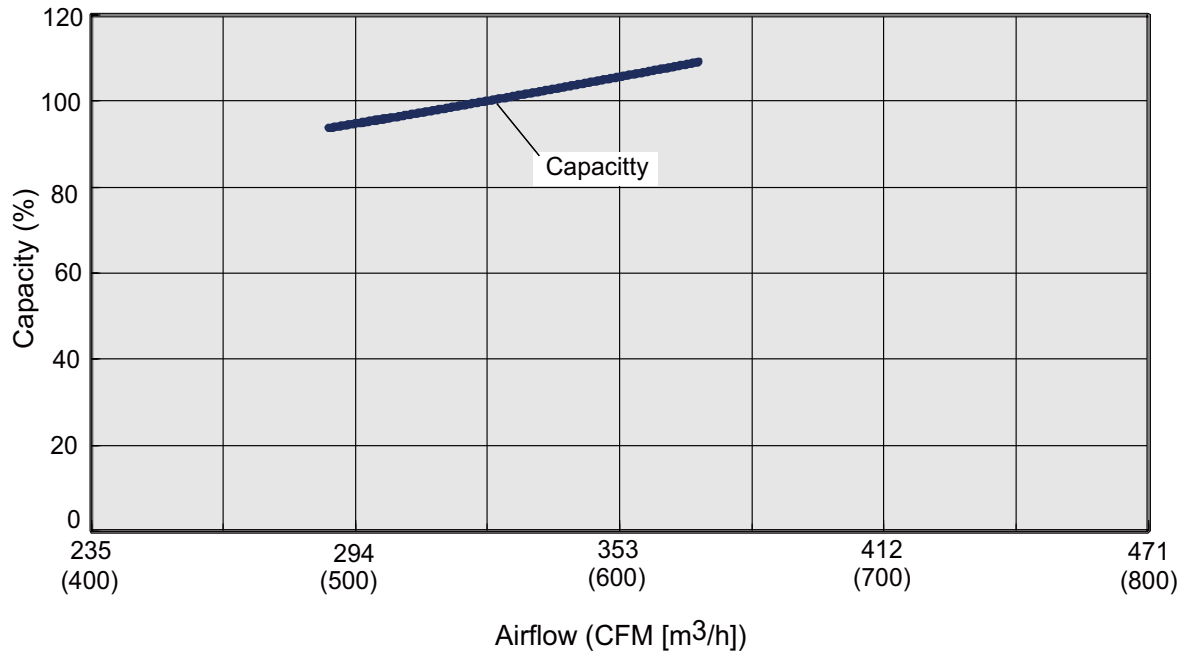

• Heating

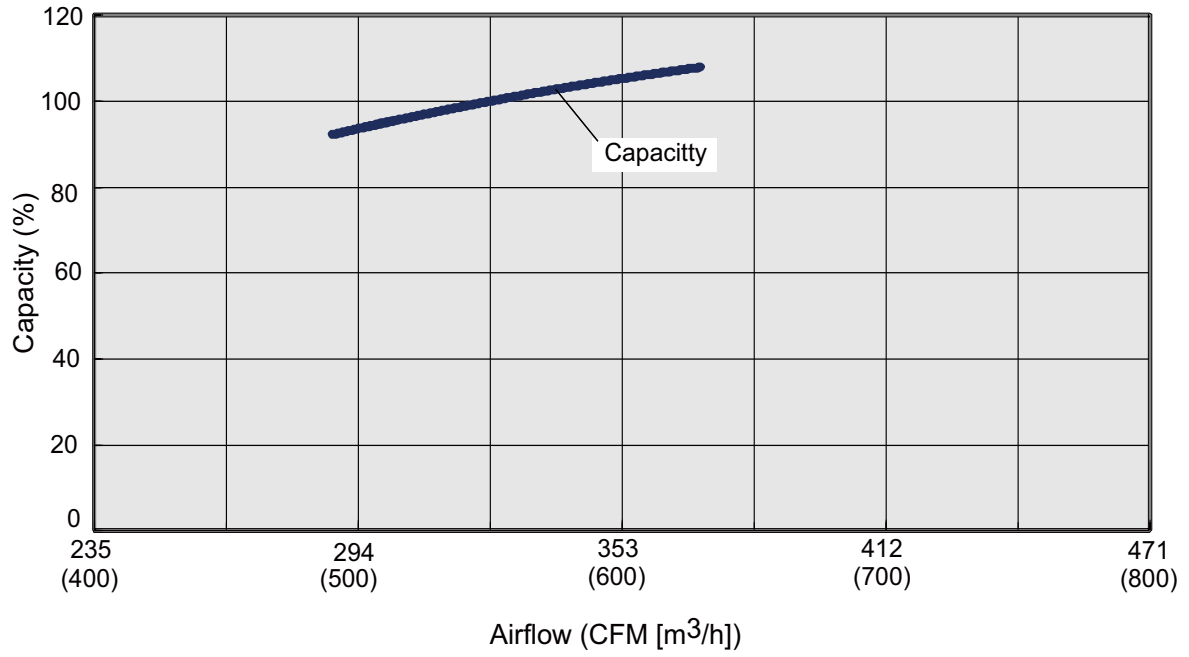

Model: ARU9RLF

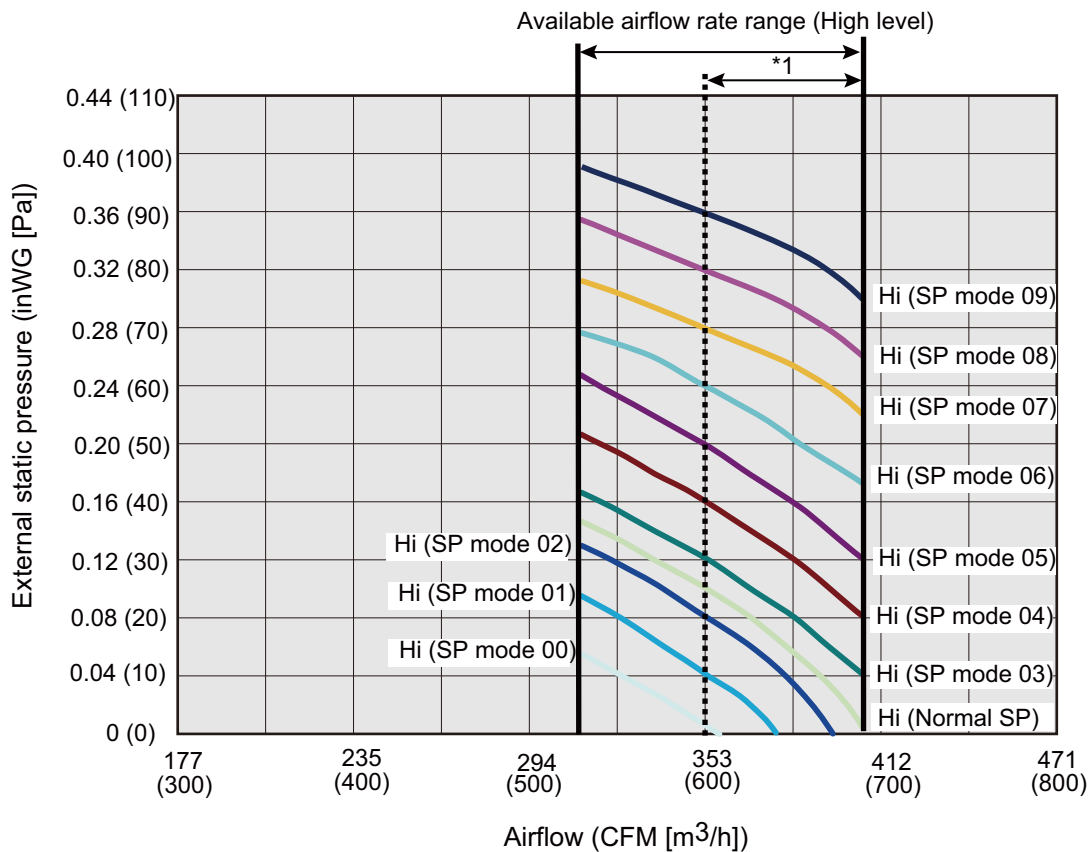
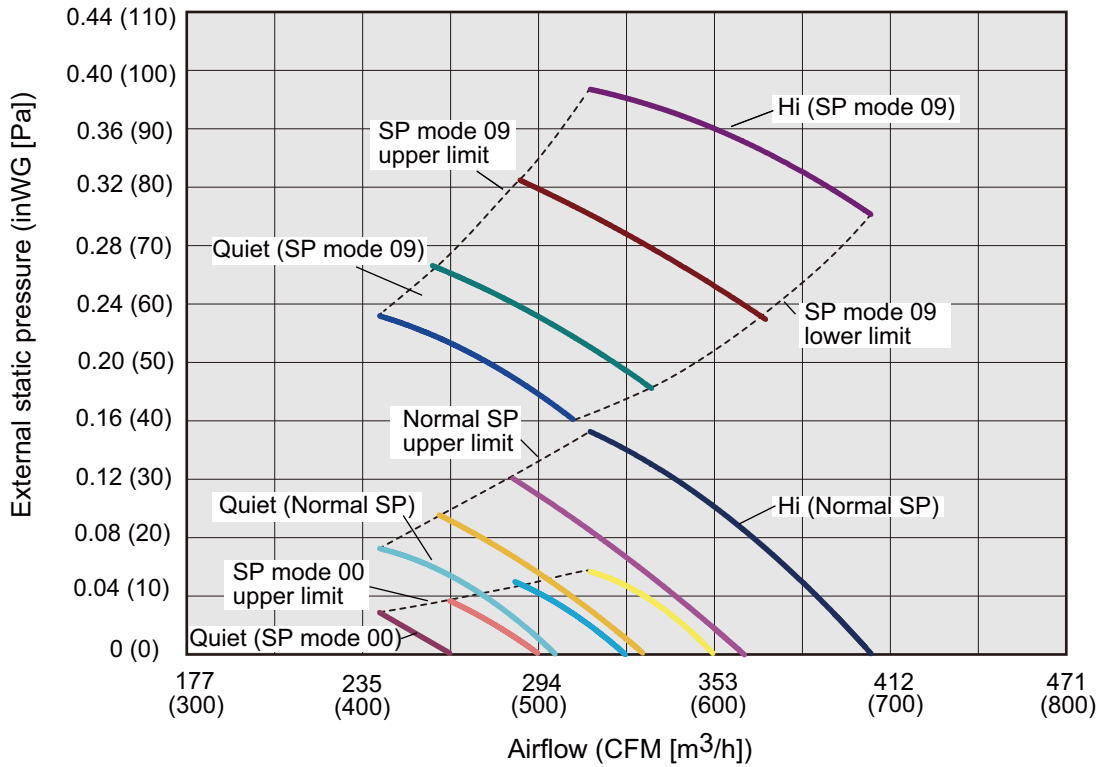

*1: Available airflow rate range when Auto louver grille (option) is installed.
 Fan speed : HIGH
 Vertical airflow direction louver : Up

● Characteristics of air volume and capacity

• Cooling

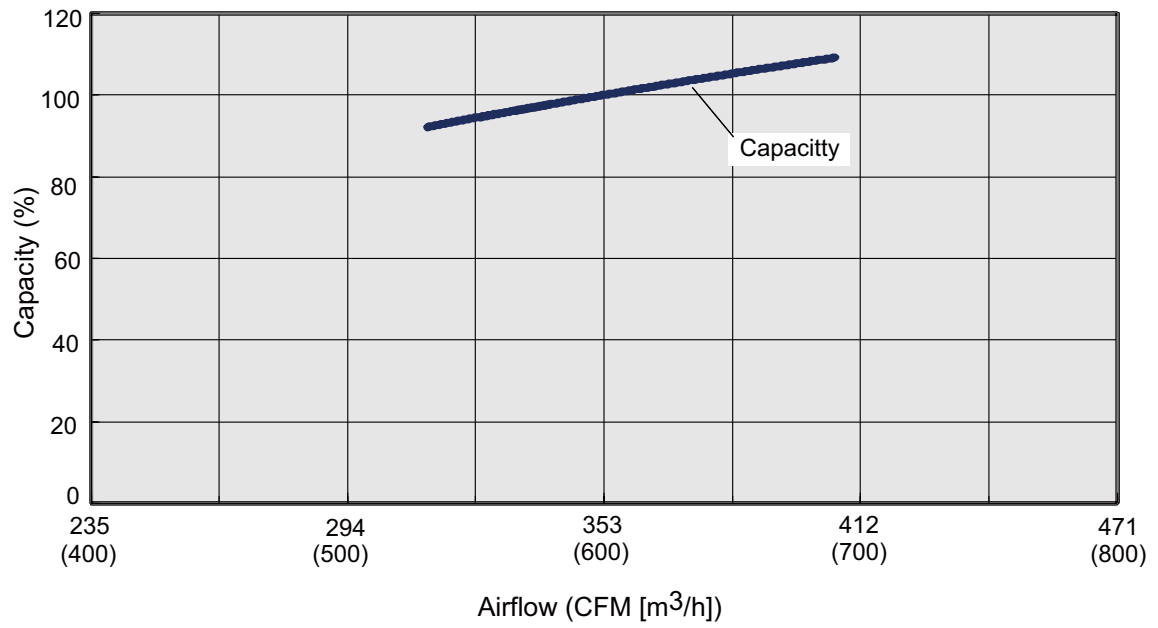

• Heating

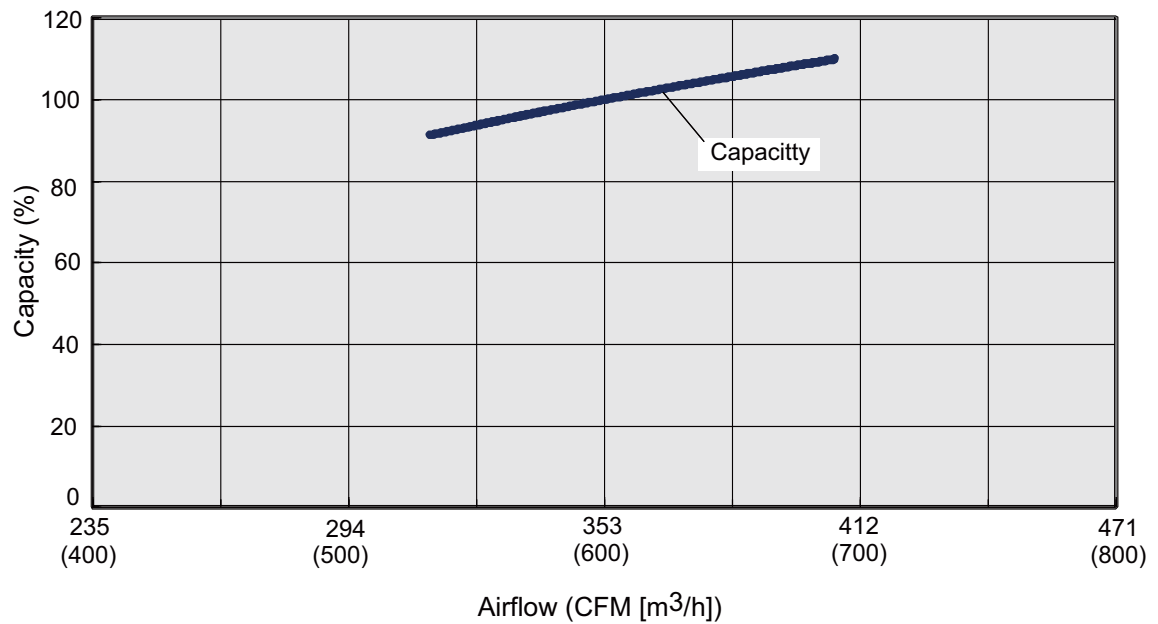

Model: ARU12RLF

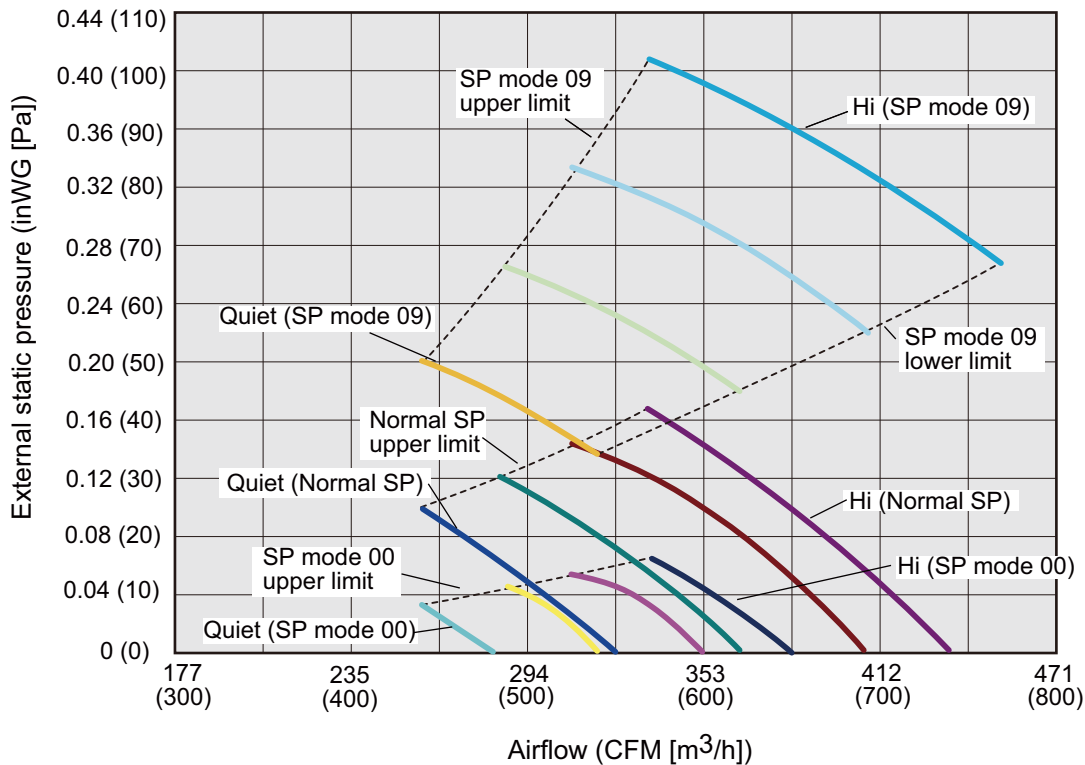

Available airflow rate range (High level)

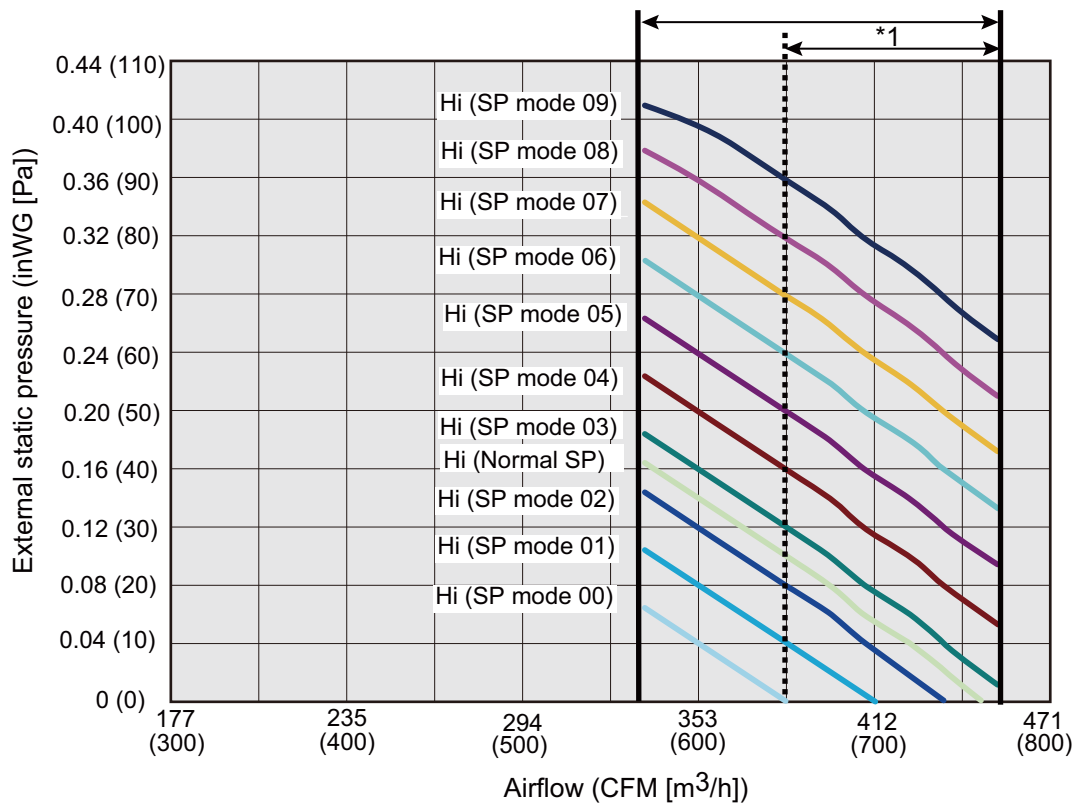

*1: Available airflow rate range when Auto louver grille (option) is installed.
 Fan speed : HIGH
 Vertical airflow direction louver : Up

● Characteristics of air volume and capacity

• Cooling

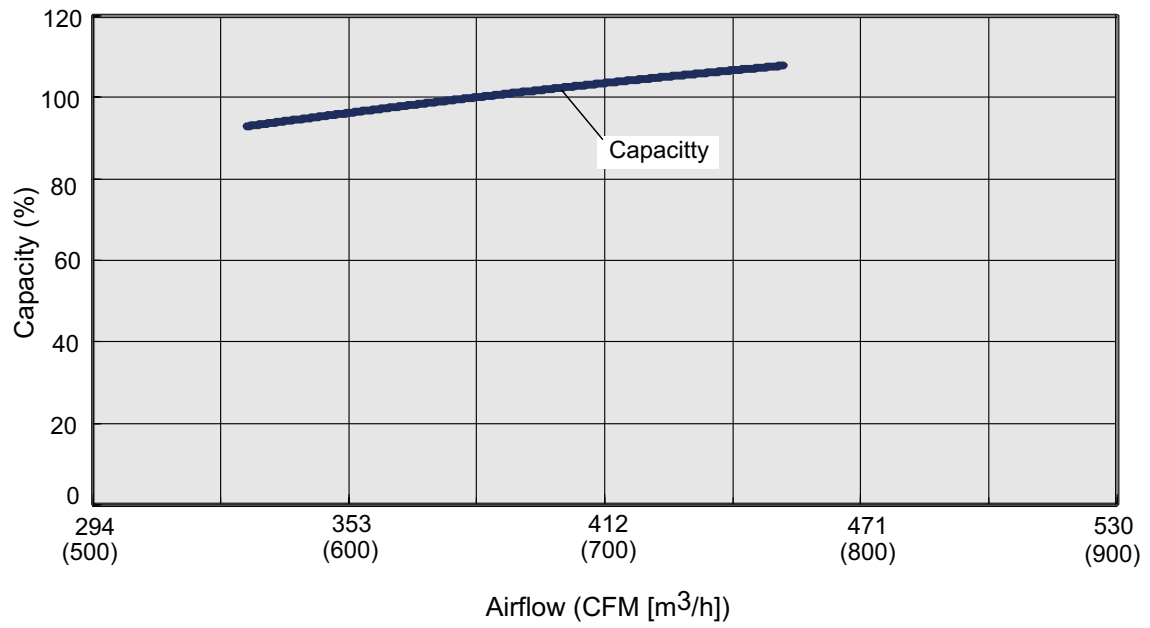

• Heating

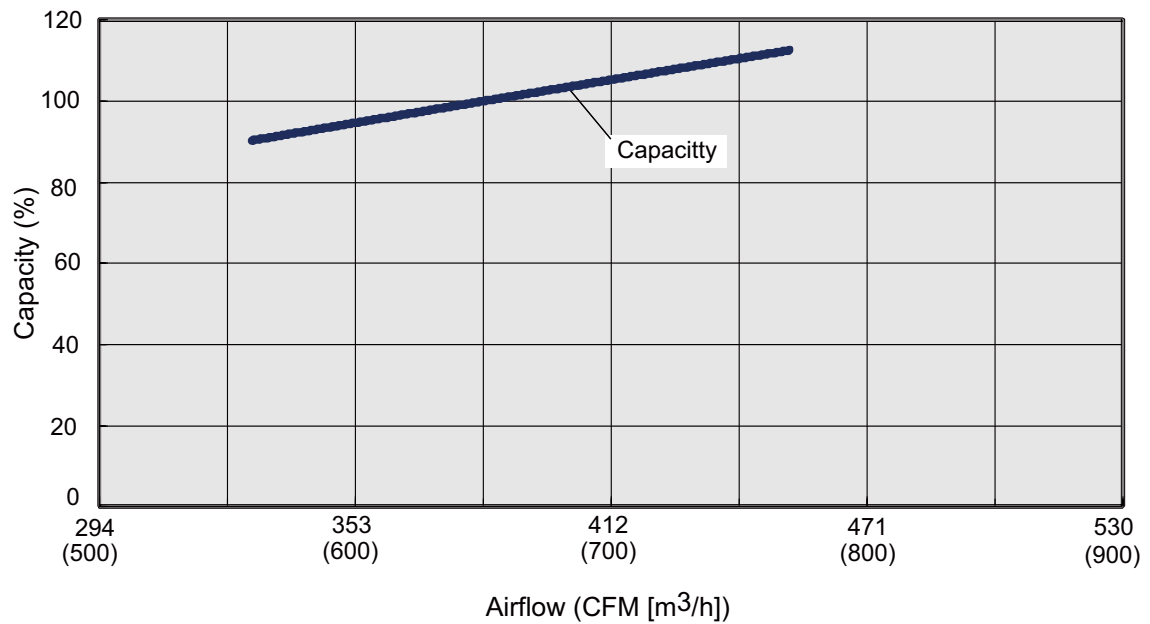

Model: ARU18RLF

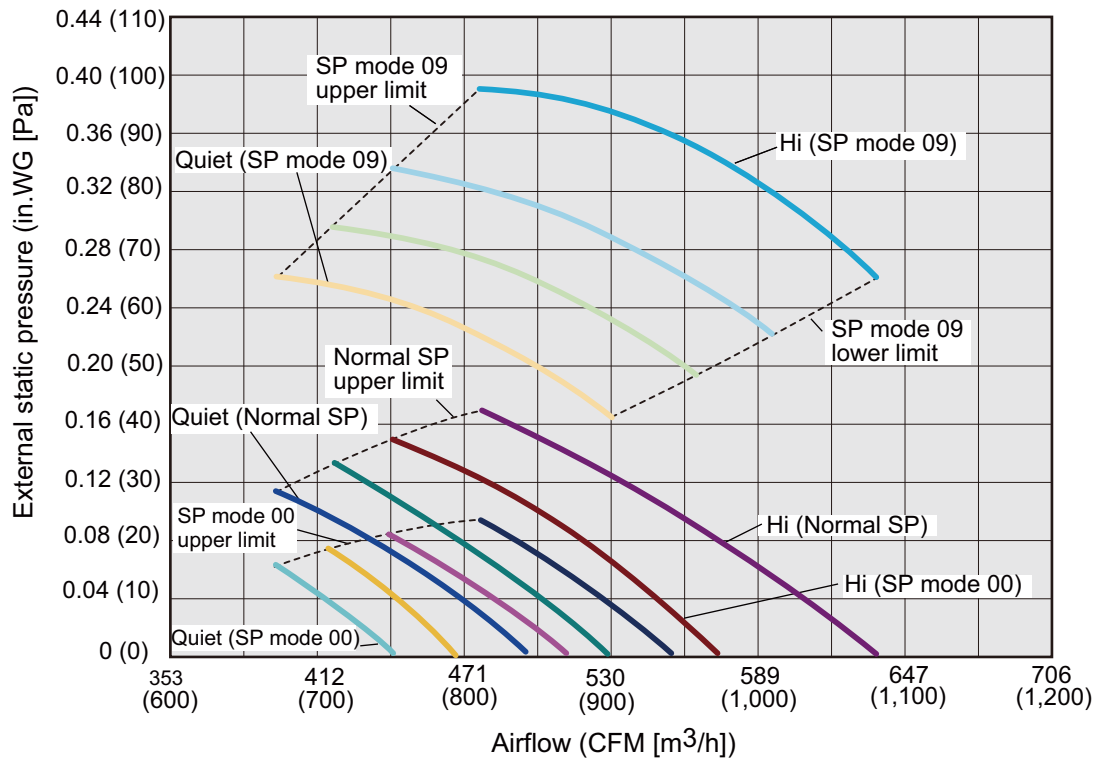

Available airflow rate range (High level)

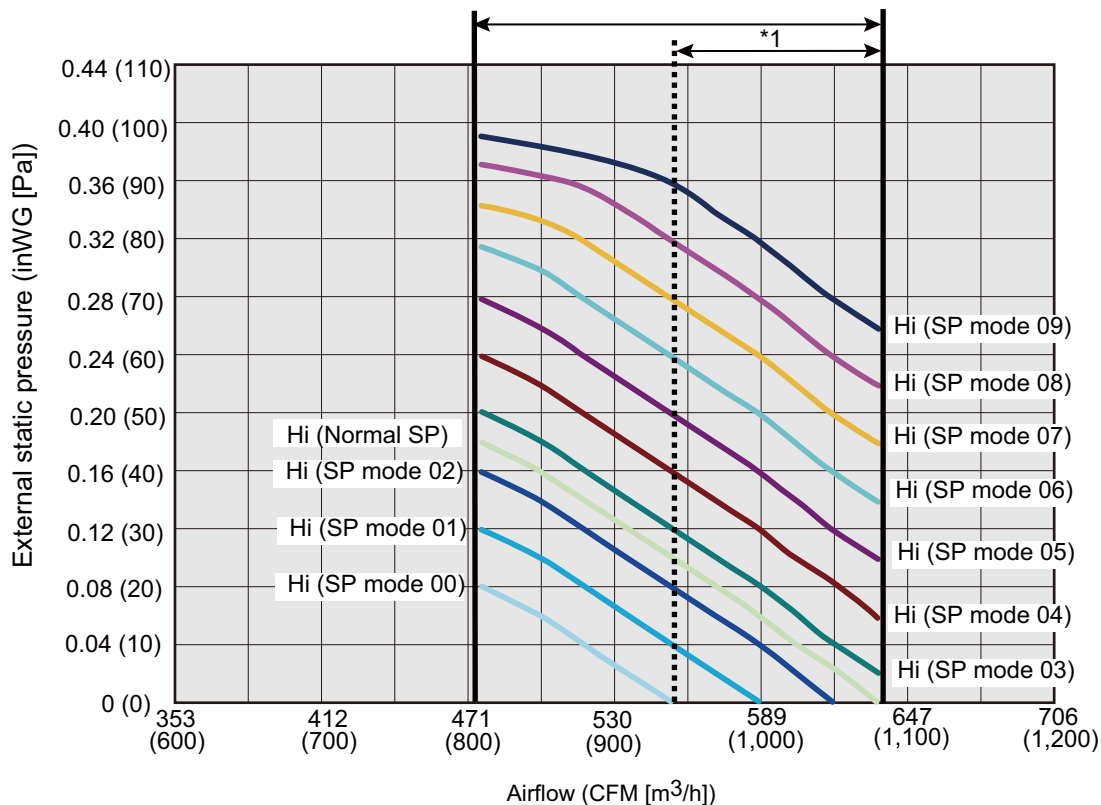

*1: Available airflow rate range when Auto louver grille (option) is installed.

Fan speed : HIGH

Vertical airflow direction louver : Up

● Characteristics of air volume and capacity

• Cooling

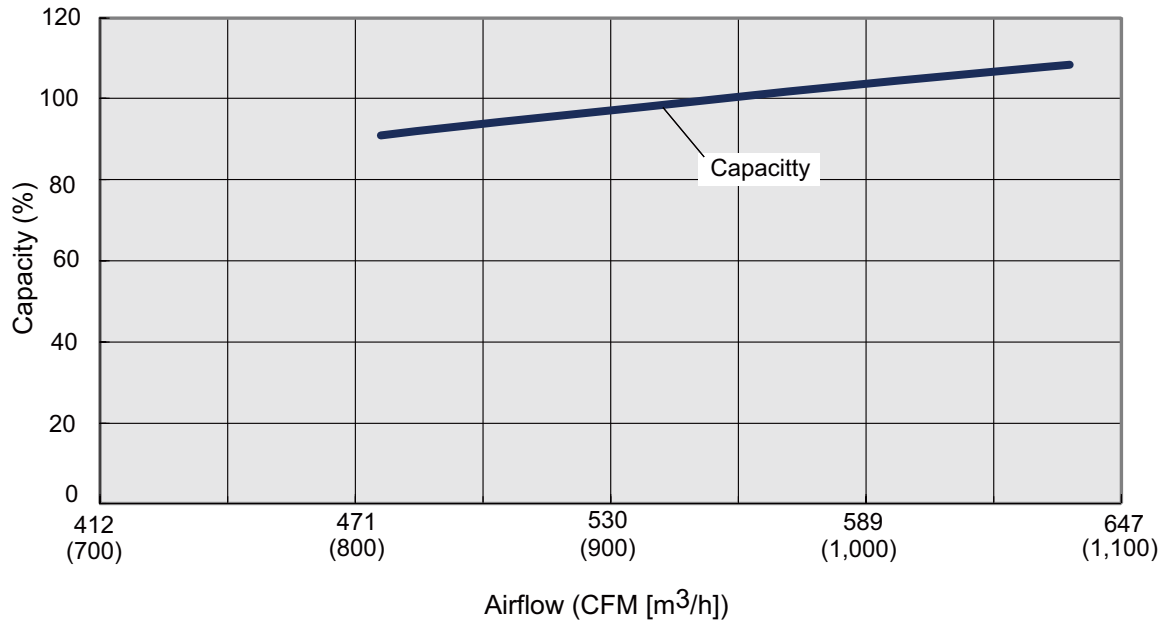

• Heating

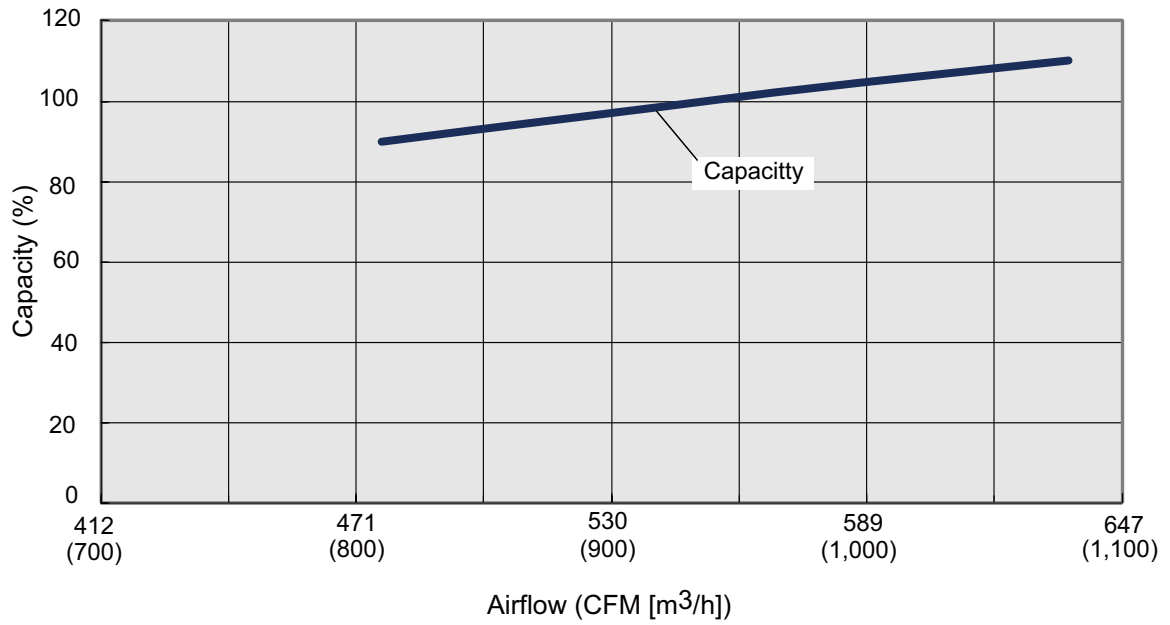

Model: ARU24RLF

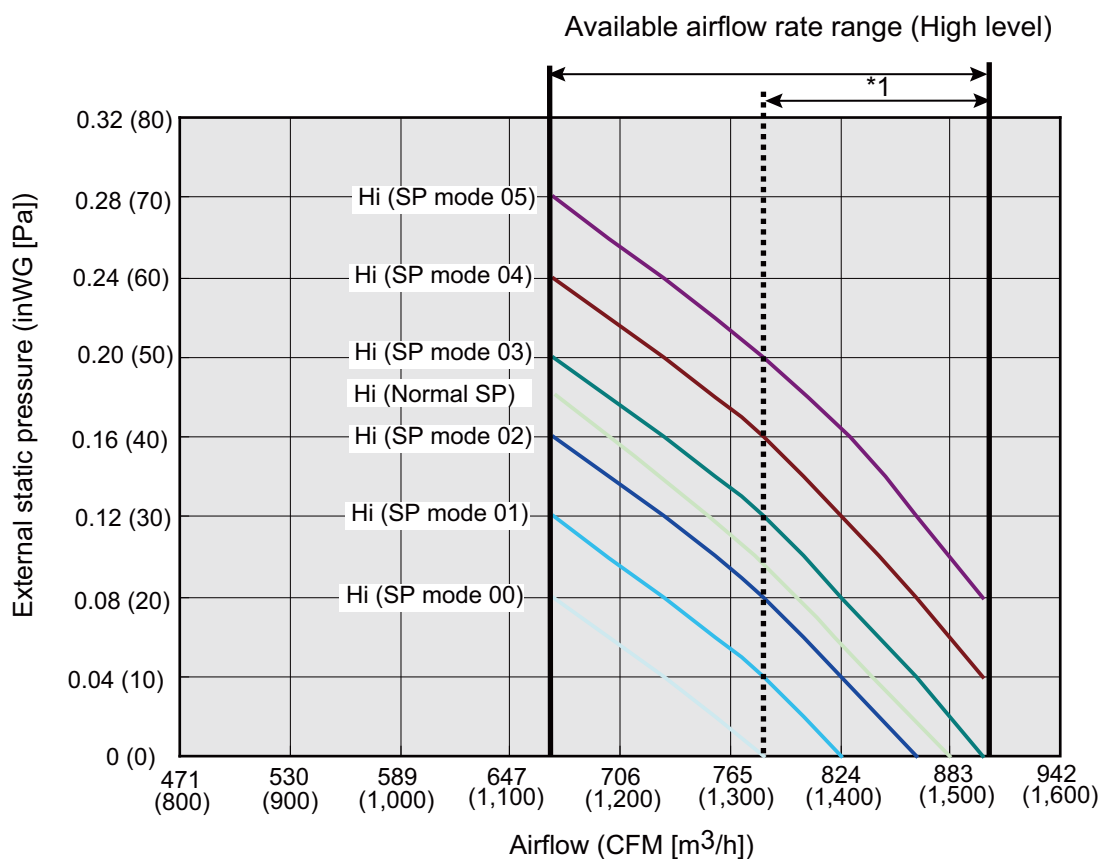
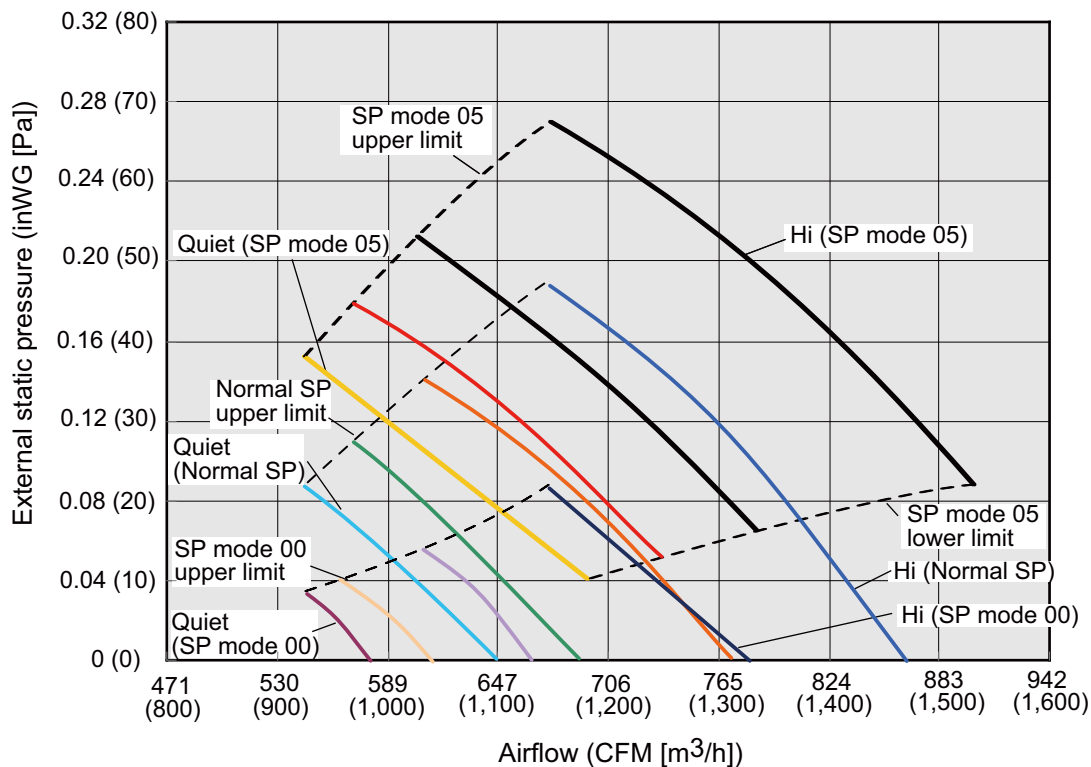

*1: Available airflow rate range when Auto louver grille (option) is installed.
 Fan speed : HIGH
 Vertical airflow direction louver : Up

● Characteristics of air volume and capacity

• Cooling

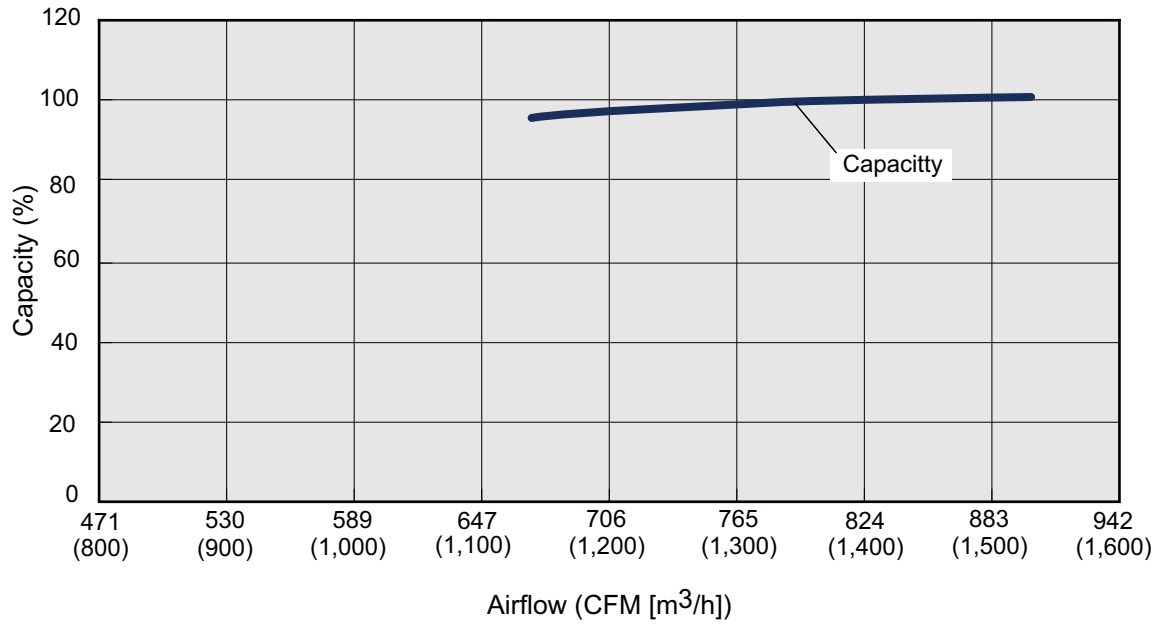

• Heating

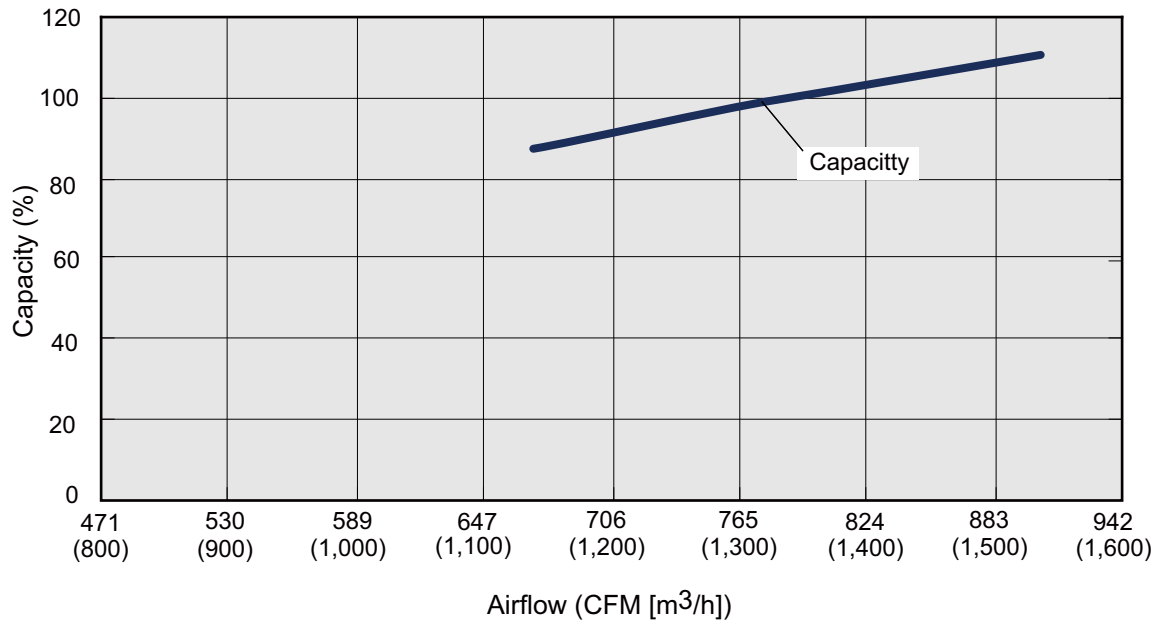

8. Airflow

Conversion factor:

- $1 \text{ m}^3/\text{h} = 0.2778 \text{ l/s} = 0.5886 \text{ CFM}$
- $3.6 \text{ m}^3/\text{h} = 1 \text{ l/s}$
- $1.699 \text{ m}^3/\text{h} = 1 \text{ CFM}$

8-1. Compact cassette type

Model	Operation mode	Fan speed	Airflow		
			m ³ /h	l/s	CFM
AUU7RLF	Cooling	High	540	150	318
		Med	490	136	288
		Low	440	122	259
		Quiet	390	108	230
	Heating	High	540	150	318
		Med	490	136	288
		Low	440	122	259
		Quiet	390	108	230
AUU9RLF	Cooling	High	540	150	318
		Med	490	136	288
		Low	440	122	259
		Quiet	390	108	230
	Heating	High	540	150	318
		Med	490	136	288
		Low	440	122	259
		Quiet	390	108	230
AUU12RLF	Cooling	High	610	169	359
		Med	530	147	312
		Low	470	131	277
		Quiet	410	114	241
	Heating	High	610	169	359
		Med	530	147	312
		Low	470	131	277
		Quiet	410	114	241
AUU18RLF	Cooling	High	750	208	441
		Med	610	169	359
		Low	520	144	306
		Quiet	410	114	241
	Heating	High	800	222	471
		Med	710	197	418
		Low	600	167	353
		Quiet	450	125	265

8-2. Slim duct type

Model	Operation mode	Fan speed	Airflow		
			m ³ /h	l/s	CFM
ARU7RLF	Cooling	High	550	153	324
		Med	490	136	288
		Low	470	131	277
		Quiet	440	122	259
	Heating	High	550	153	324
		Med	490	136	288
		Low	470	131	277
		Quiet	440	122	259
ARU9RLF	Cooling	High	600	167	353
		Med	550	153	324
		Low	500	139	294
		Quiet	450	125	265
	Heating	High	600	167	353
		Med	550	153	324
		Low	500	139	294
		Quiet	450	125	265
ARU12RLF	Cooling	High	650	181	383
		Med	600	167	353
		Low	550	153	324
		Quiet	480	133	283
	Heating	High	650	181	383
		Med	600	167	353
		Low	550	153	324
		Quiet	480	133	283
ARU18RLF	Cooling	High	940	261	554
		Med	880	244	518
		Low	820	227	483
		Quiet	750	208	441
	Heating	High	940	261	554
		Med	880	244	518
		Low	820	227	483
		Quiet	750	208	441
ARU24RLF	Cooling	High	1,330	369	783
		Med	1,240	344	730
		Low	1,100	306	648
		Quiet	1,030	286	607
	Heating	High	1,330	369	783
		Med	1,240	344	730
		Low	1,100	306	648
		Quiet	1,030	286	607

8-3. Wall mounted type

Model	Operation mode	Fan speed	Airflow		
			m ³ /h	l/s	CFM
ASU7RLF1	Cooling	High	560	156	330
		Med	500	139	294
		Low	430	119	253
		Quiet	310	86	182
	Heating	High	560	156	330
		Med	500	139	294
		Low	430	119	253
		Quiet	330	92	194
ASU9RLF1	Cooling	High	600	167	353
		Med	520	144	306
		Low	430	119	253
		Quiet	310	86	182
	Heating	High	600	167	353
		Med	520	144	306
		Low	430	119	253
		Quiet	330	92	194
ASU12RLF1	Cooling	High	660	183	388
		Med	560	156	330
		Low	450	125	265
		Quiet	310	86	182
	Heating	High	660	183	388
		Med	560	156	330
		Low	470	131	277
		Quiet	330	92	194
ASU15RLF1	Cooling	High	730	203	430
		Med	600	167	353
		Low	530	147	312
		Quiet	360	100	212
	Heating	High	730	203	430
		Med	615	171	362
		Low	560	156	330
		Quiet	375	104	221
ASU18RLF	Cooling	High	920	256	542
		Med	740	206	436
		Low	620	172	365
		Quiet	550	153	324
	Heating	High	920	256	542
		Med	740	206	436
		Low	620	172	365
		Quiet	550	153	324
ASU24RLF	Cooling	High	1,120	311	659
		Med	900	250	530
		Low	740	206	436
		Quiet	620	172	365
	Heating	High	1,100	306	647
		Med	900	250	530
		Low	740	206	436
		Quiet	620	172	365

8-4. Floor type

Model	Operation mode	Fan speed	Airflow		
			m ³ /h	l/s	CFM
AGU9RLF	Cooling	High	530	147	312
		Med	440	122	259
		Low	360	100	212
		Quiet	270	75	159
	Heating	High	530	147	312
		Med	460	128	270
		Low	380	106	224
		Quiet	270	75	159
AGU12RLF	Cooling	High	600	167	353
		Med	490	136	288
		Low	380	106	224
		Quiet	270	75	159
	Heating	High	600	167	353
		Med	510	142	300
		Low	410	114	241
		Quiet	270	75	159
AGU15RLF	Cooling	High	650	181	383
		Med	520	144	306
		Low	400	111	235
		Quiet	270	75	159
	Heating	High	650	181	383
		Med	540	150	318
		Low	430	119	253
		Quiet	270	75	159

9. Noise level curve

9-1. Compact cassette type

Model: AUU7RLF

● Cooling

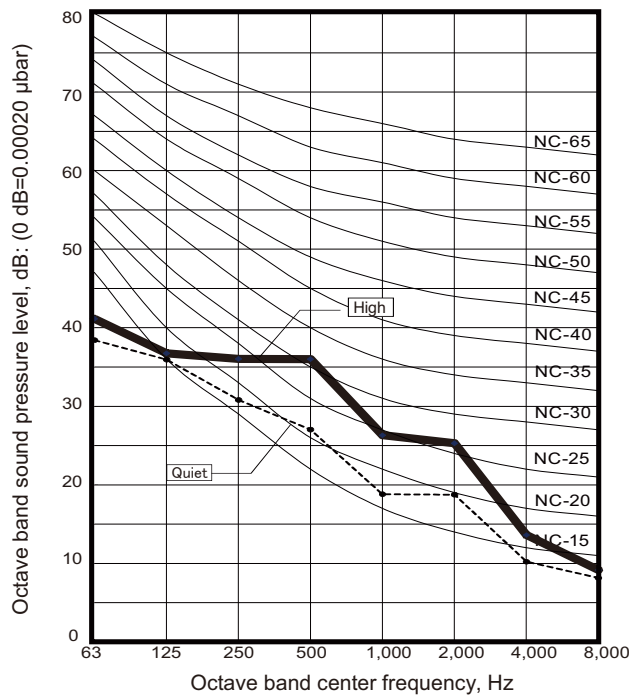

● Heating

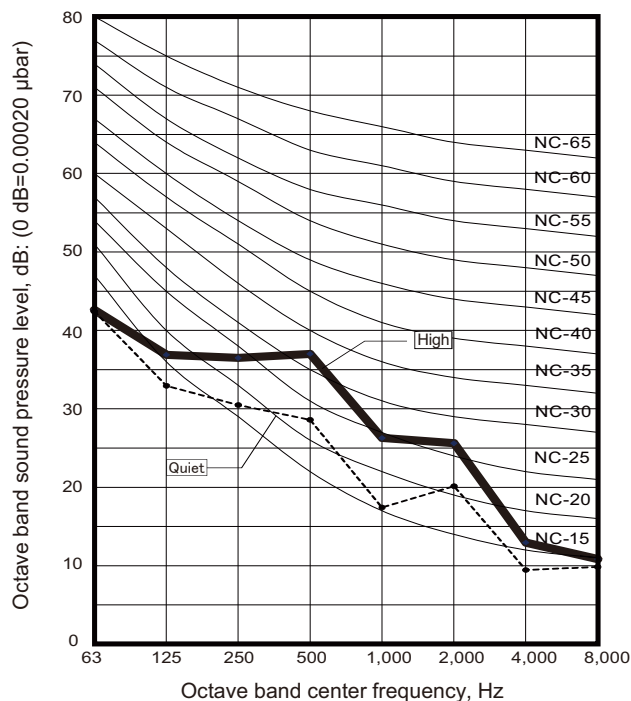

Model: AUU9RLF

● Cooling

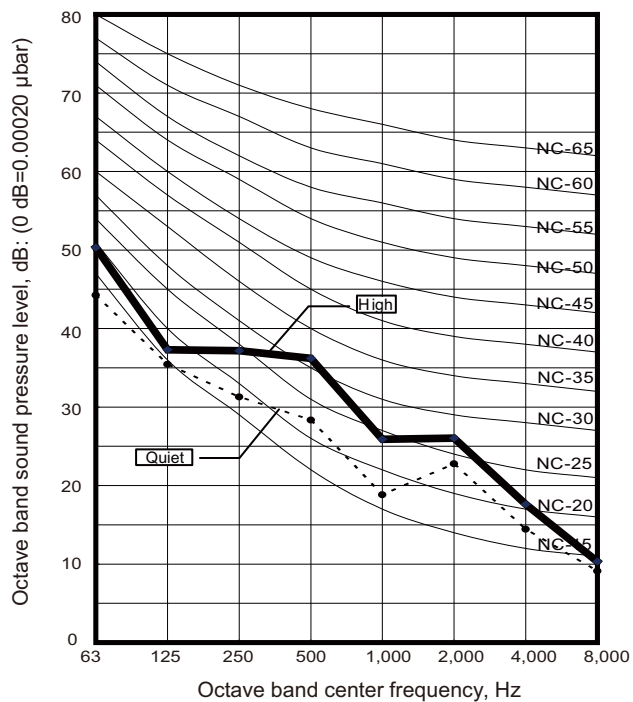

● Heating

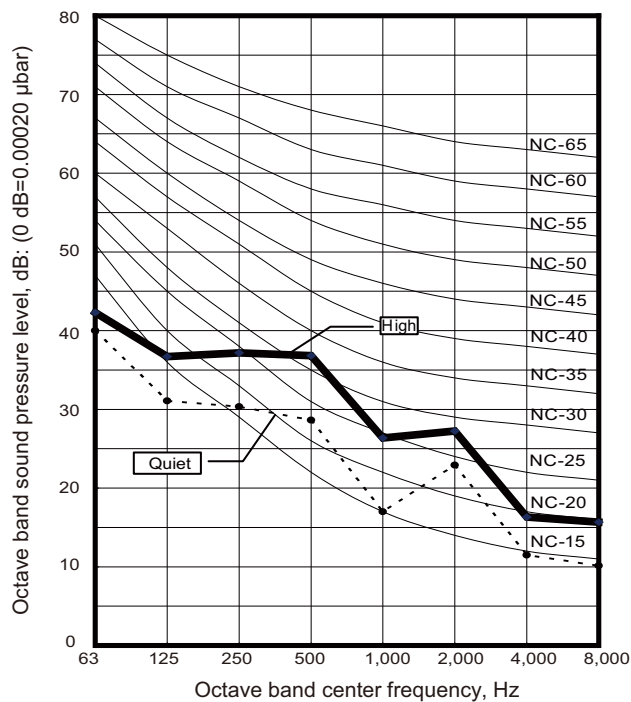

Model: AUU12RLF

Cooling

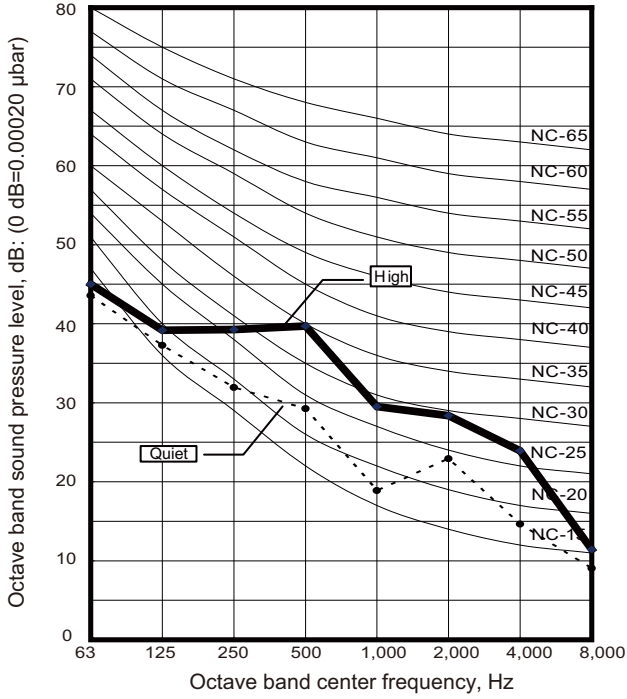

Heating

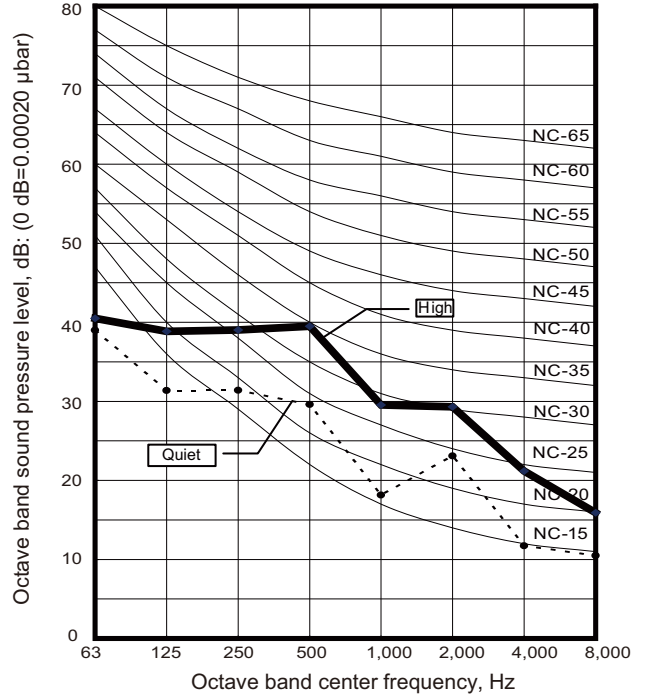

Model: AUU18RLF

Cooling

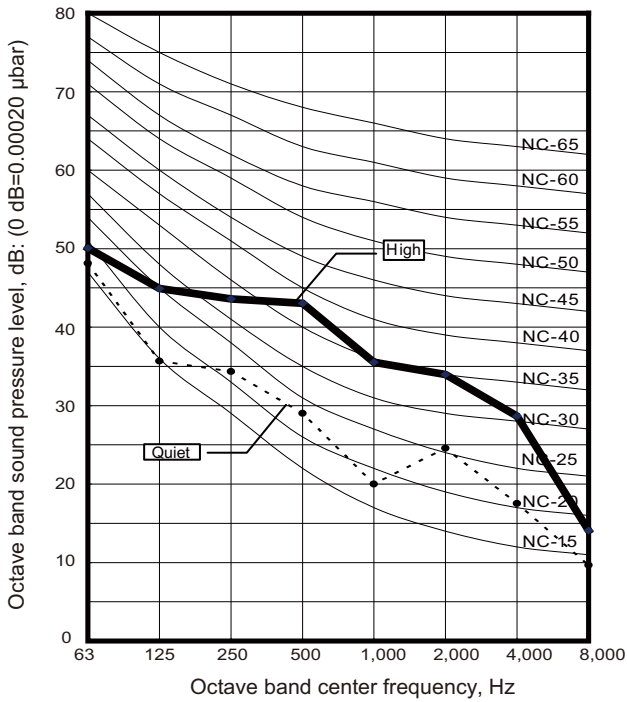

Heating

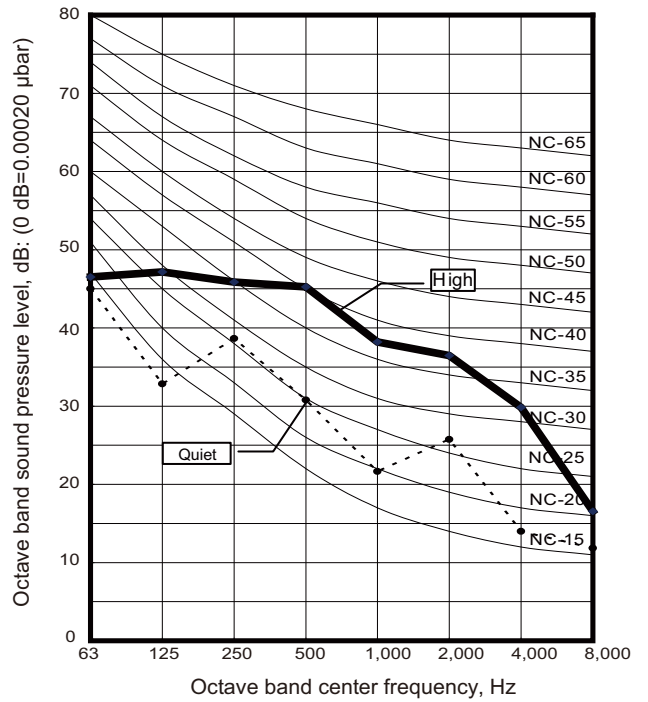

9-2. Slim duct type

■ Model: ARU7RLF

● Cooling

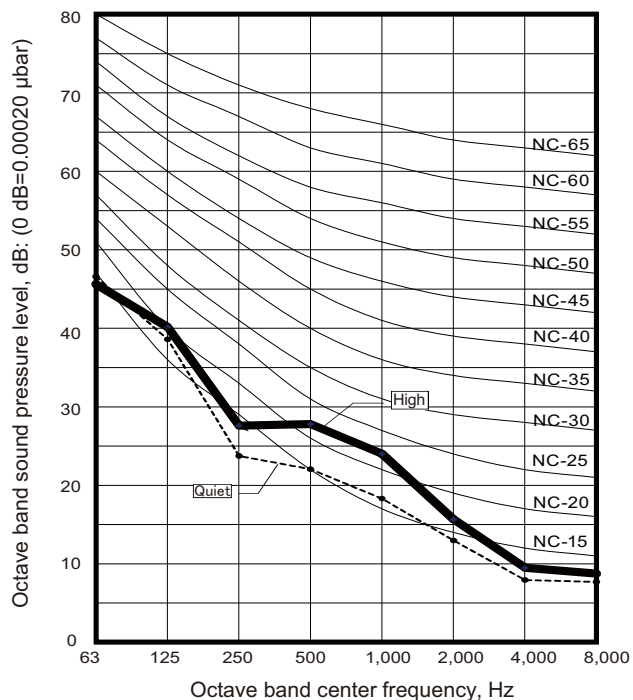

● Heating

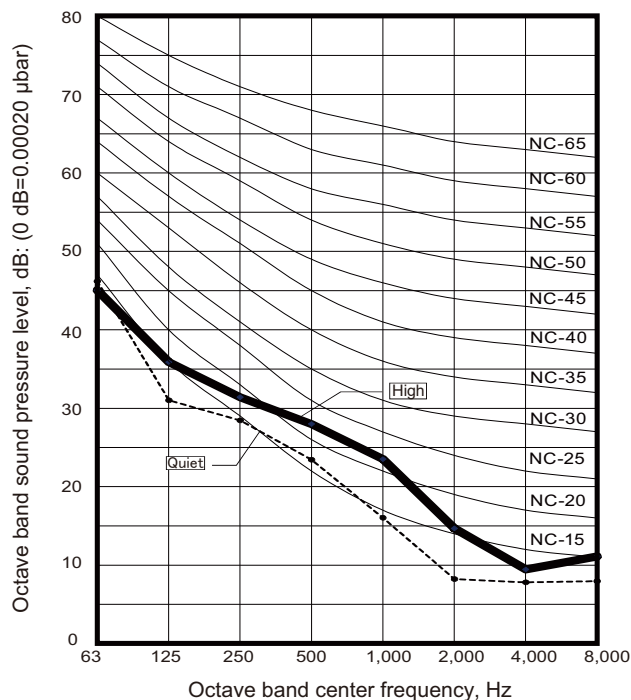

■ Model: ARU9RLF

● Cooling

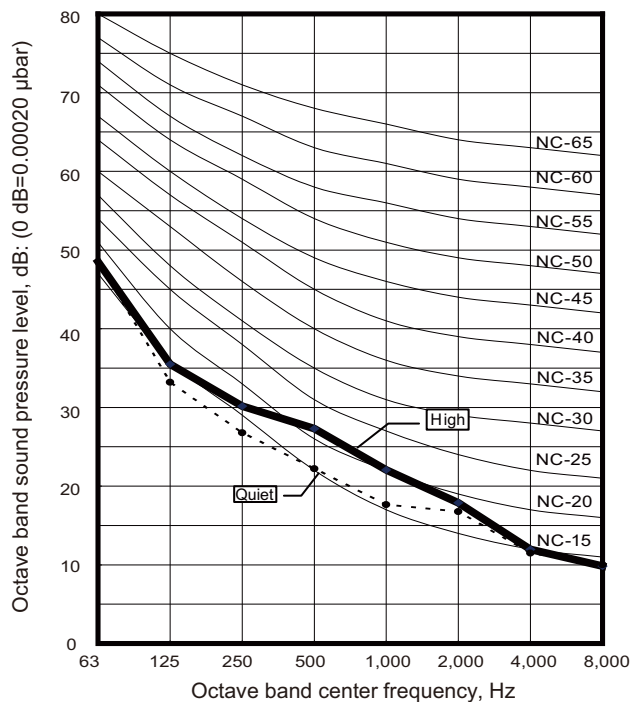

● Heating

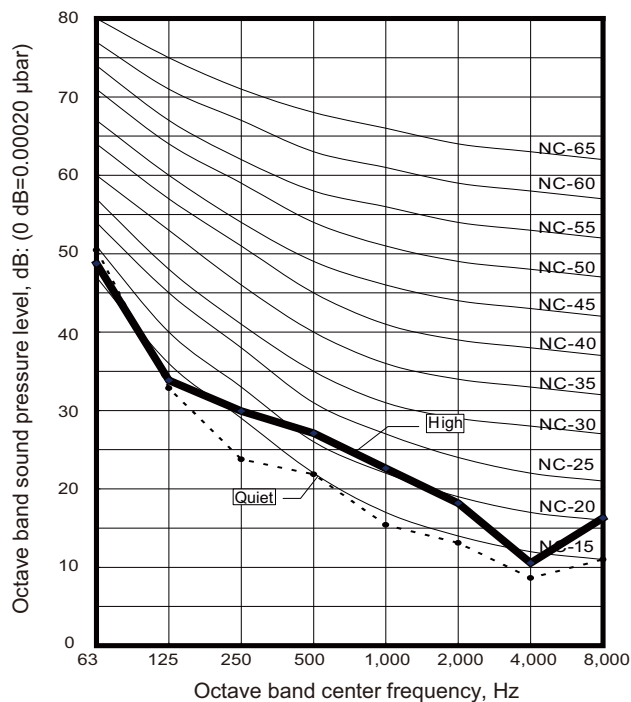

Model: ARU12RLF

Cooling

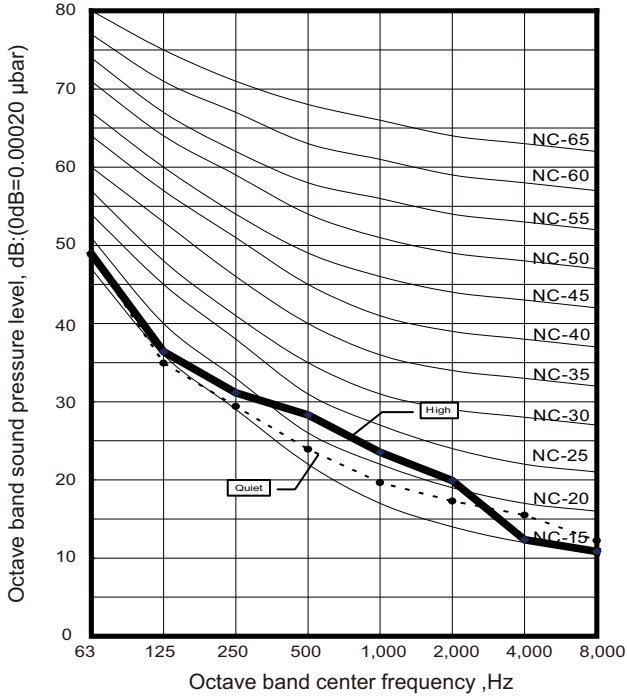

Heating

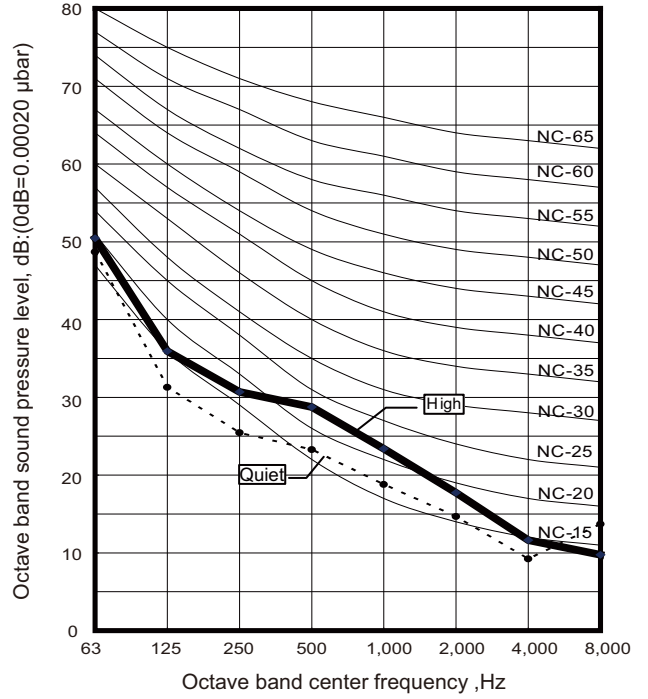

Model: ARU18RLF

Cooling

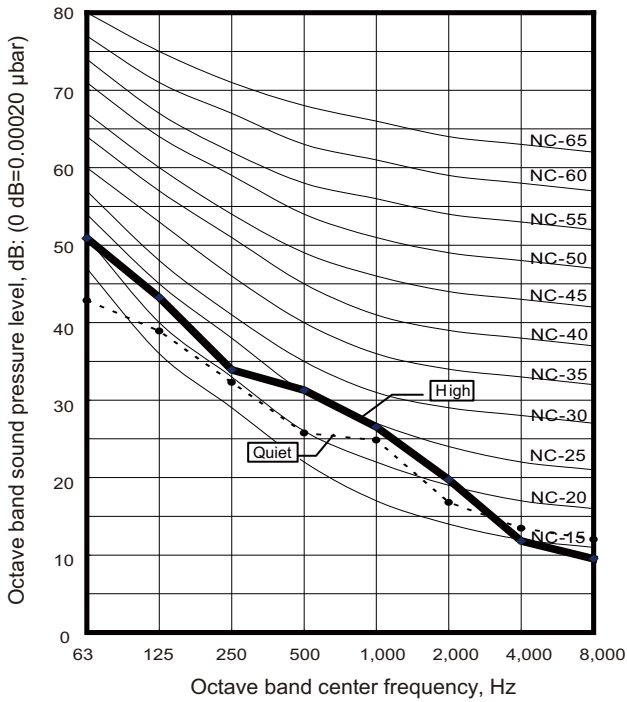

Heating

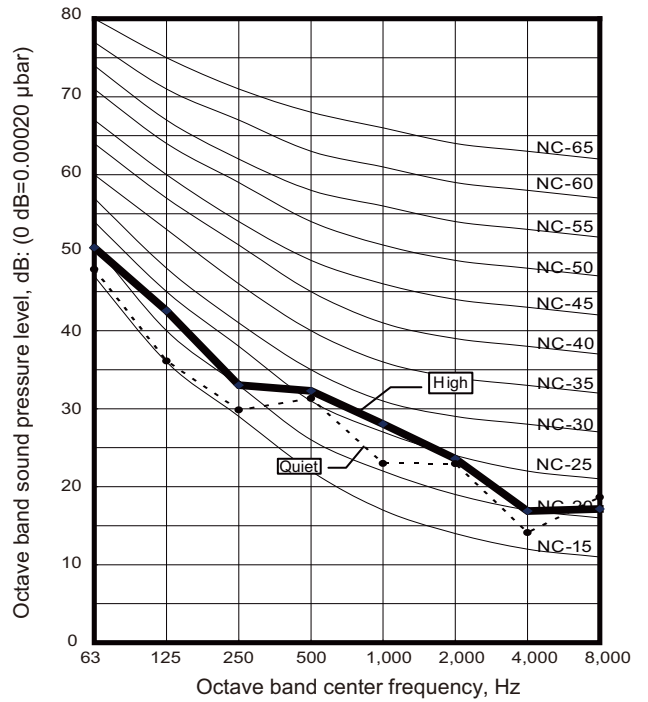

Model: ARU24RLF

● Cooling

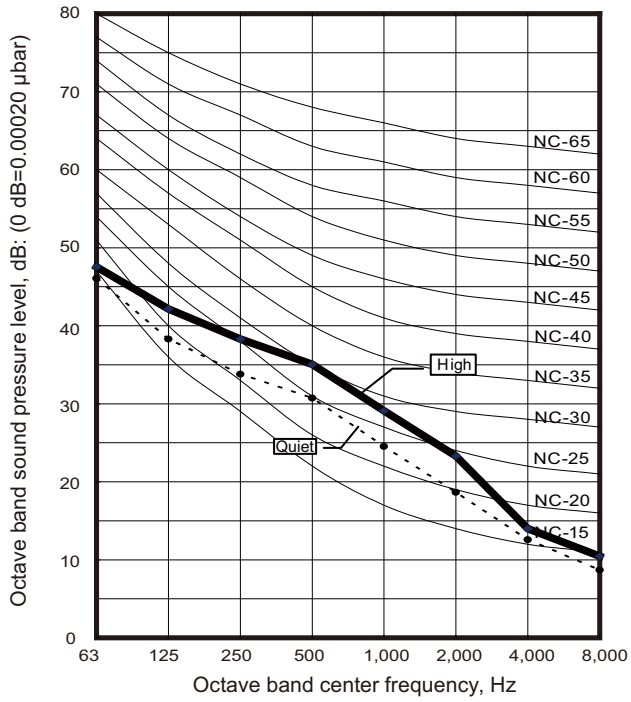

● Heating

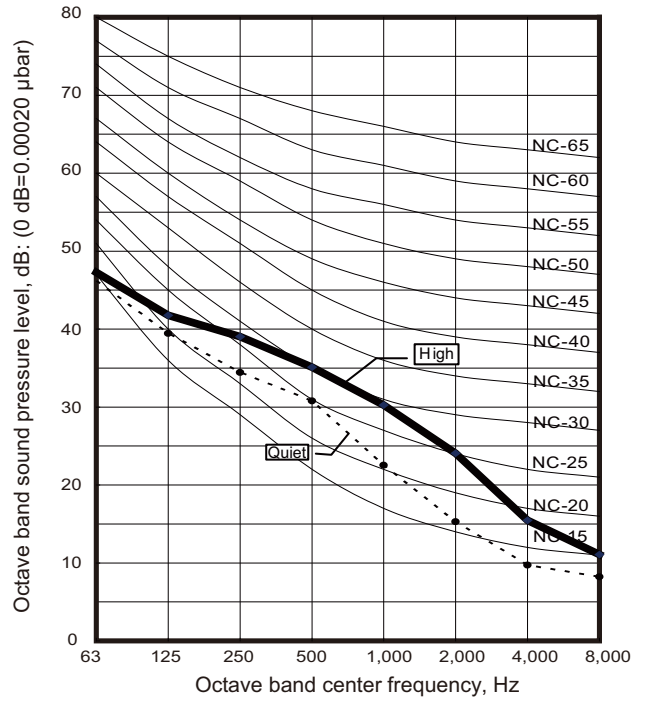

9-3. Wall mounted type

■ Model: ASU7RLF1

● Cooling

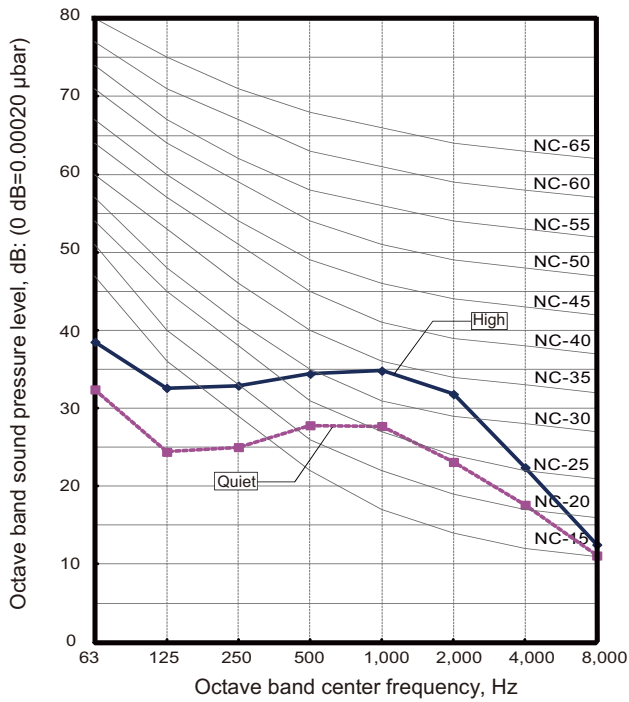

● Heating

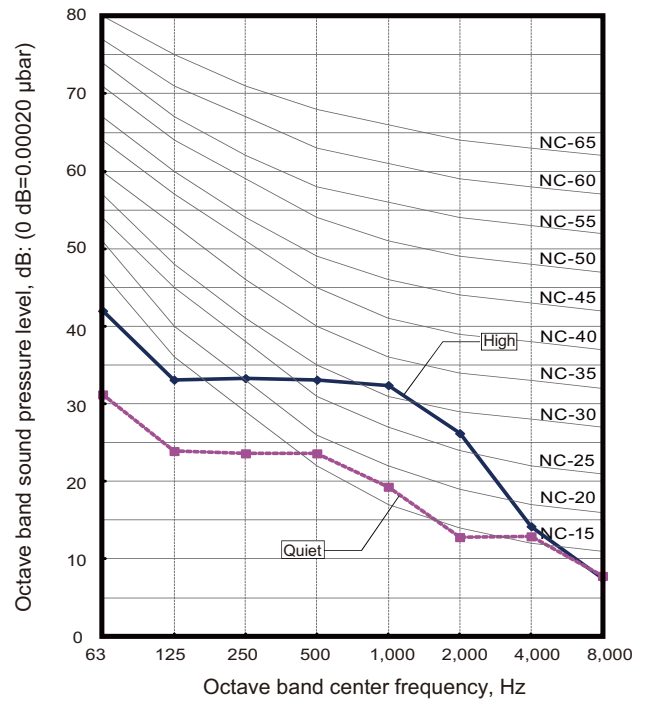

■ Model: ASU9RLF1

● Cooling

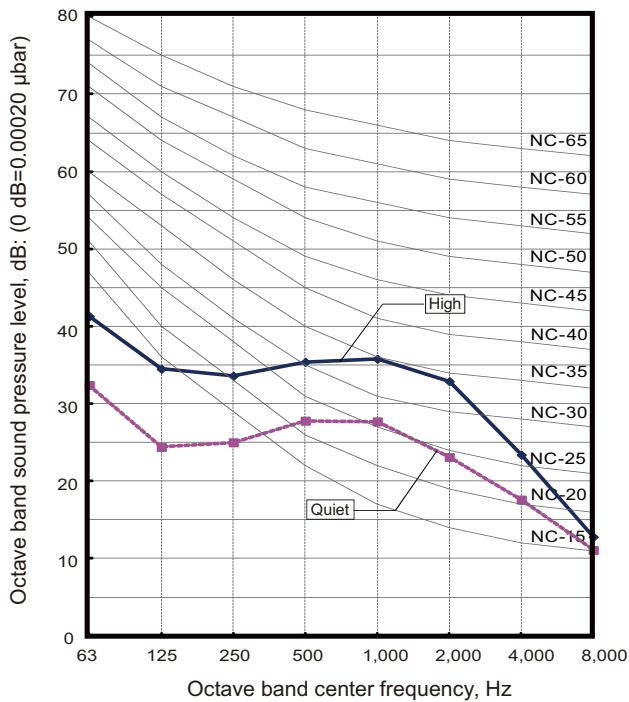

● Heating

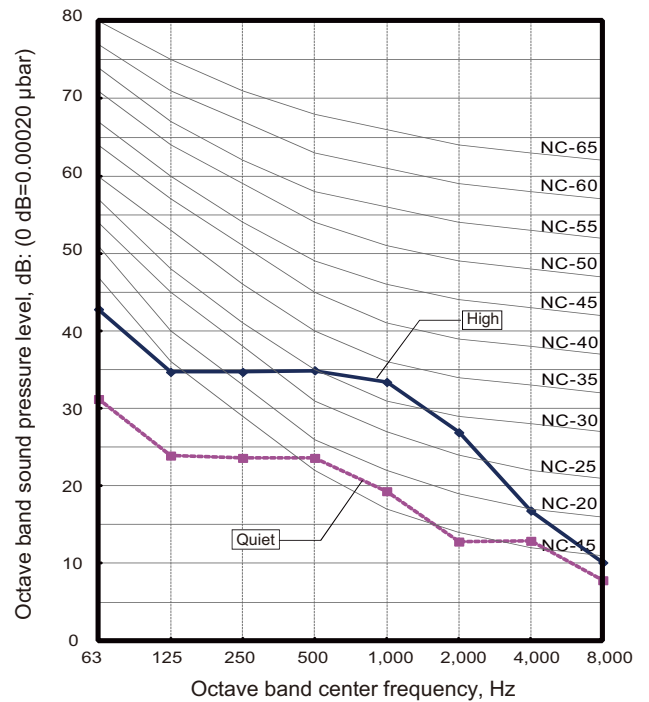

Model: ASU12RLF1

Cooling

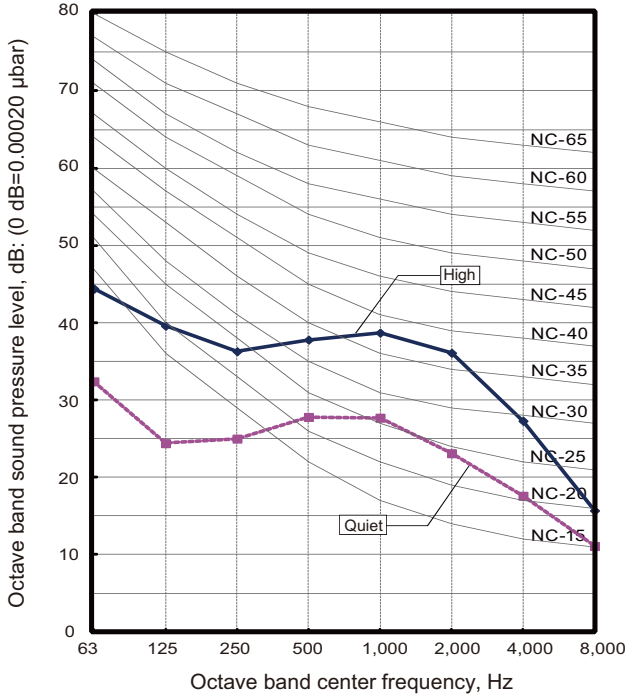

Heating

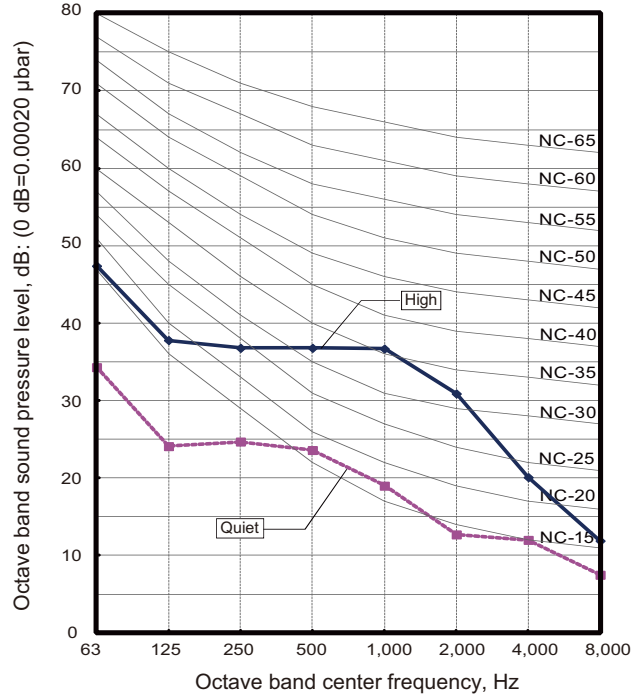

Model: ASU15RLF1

Cooling

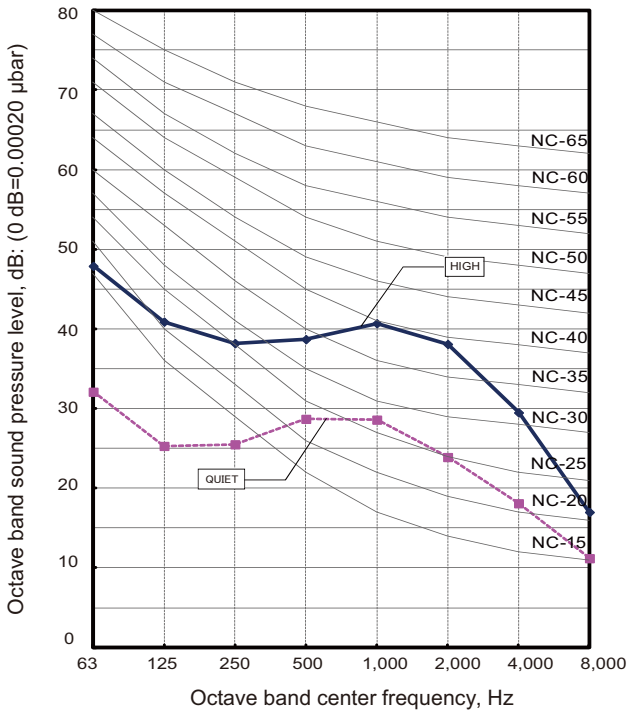

Heating

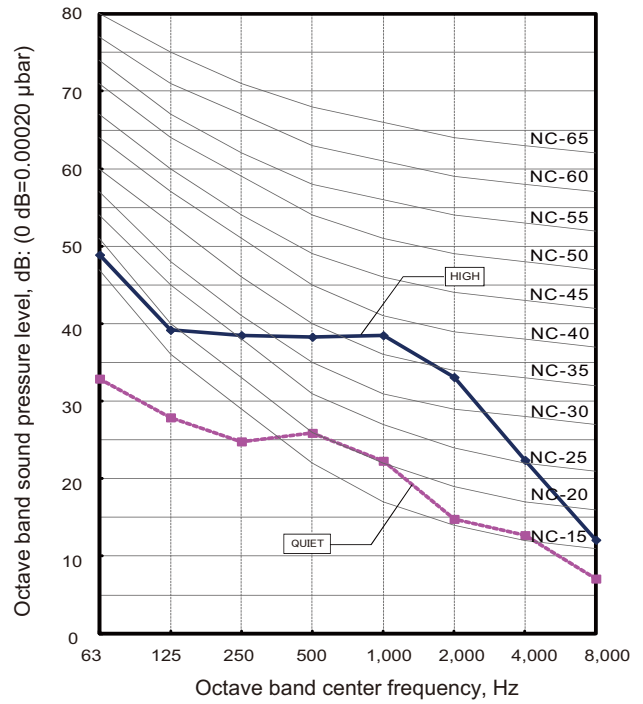

Model: ASU18RLF

Cooling

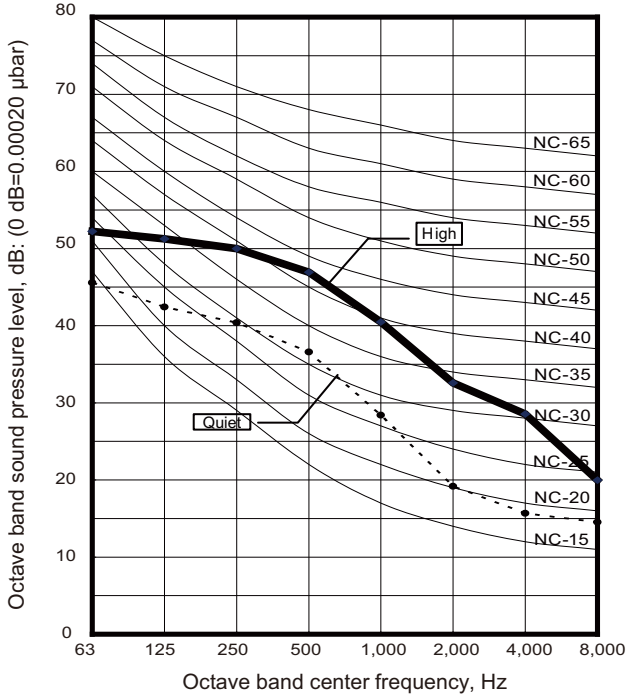

Heating

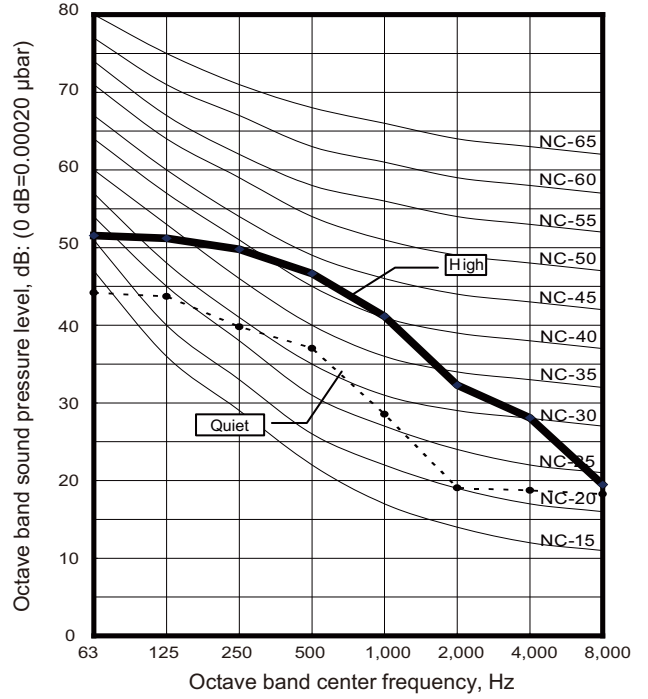

Model: ASU24RLF

Cooling

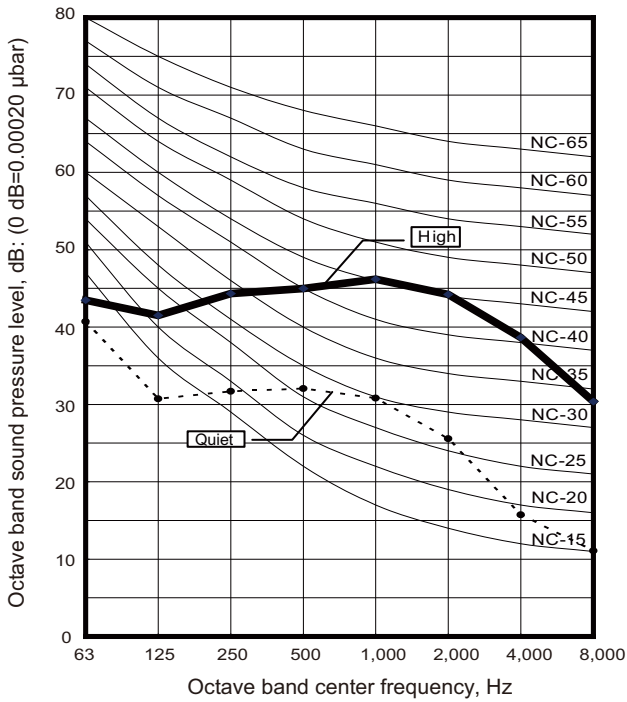

Heating

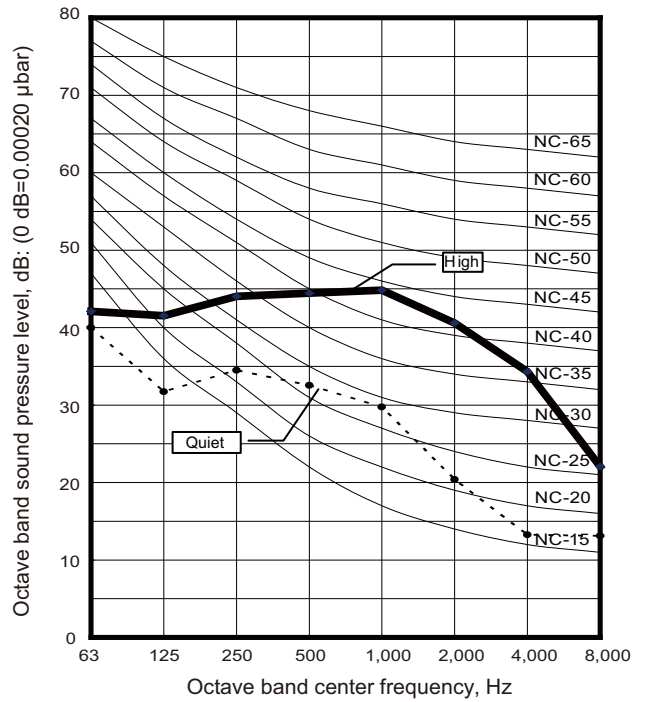

9-4. Floor type

■ Model: AGU9RLF

● Cooling

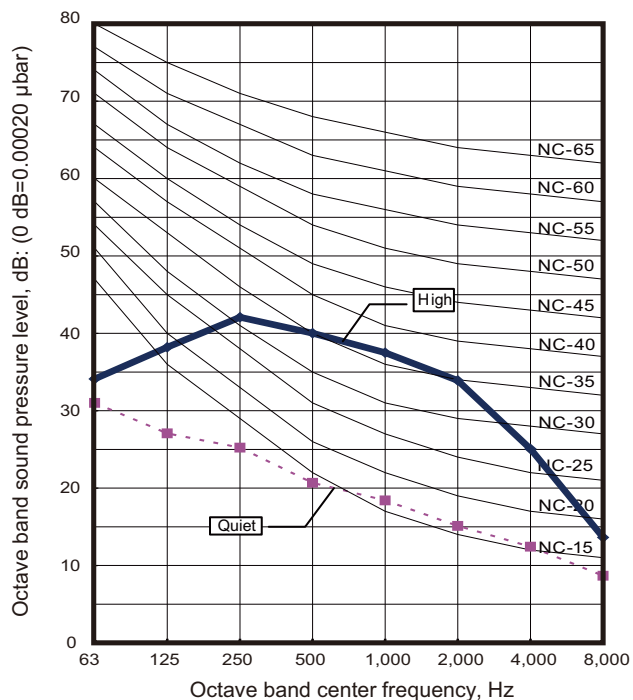

● Heating

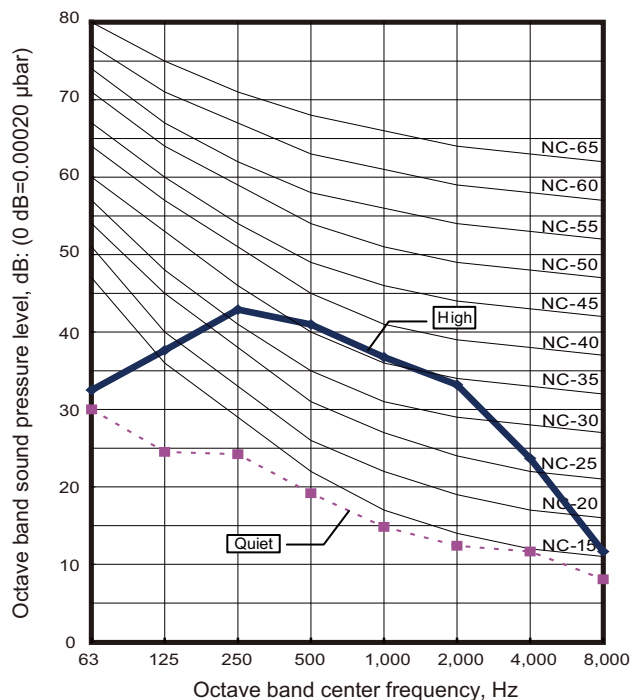

■ Model: AGU12RLF

● Cooling

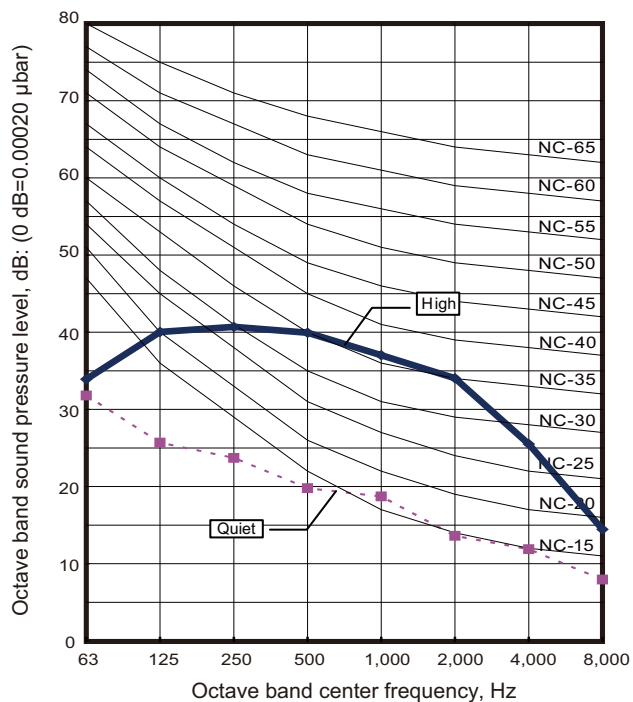

● Heating

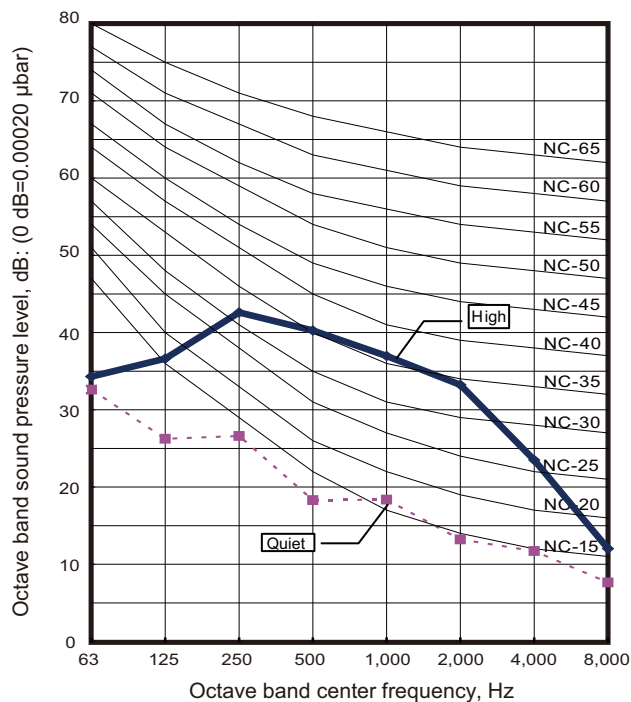

Model: AGU15RLF

● Cooling

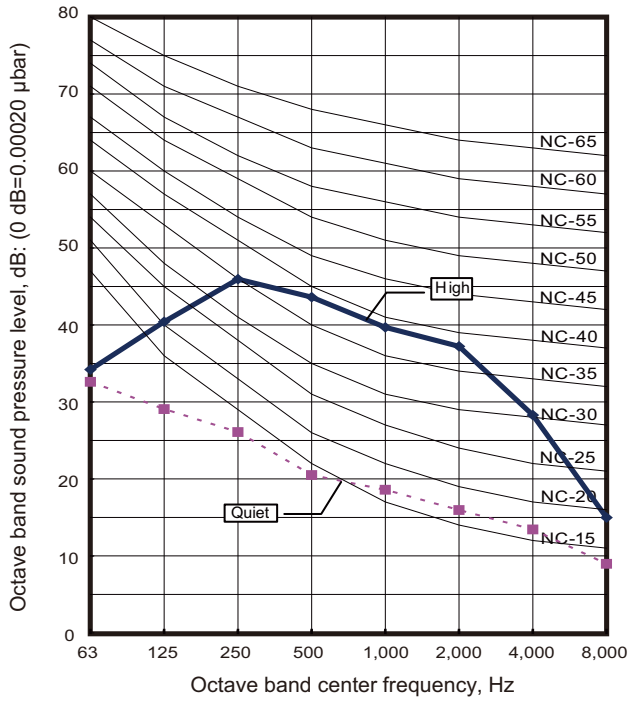

● Heating

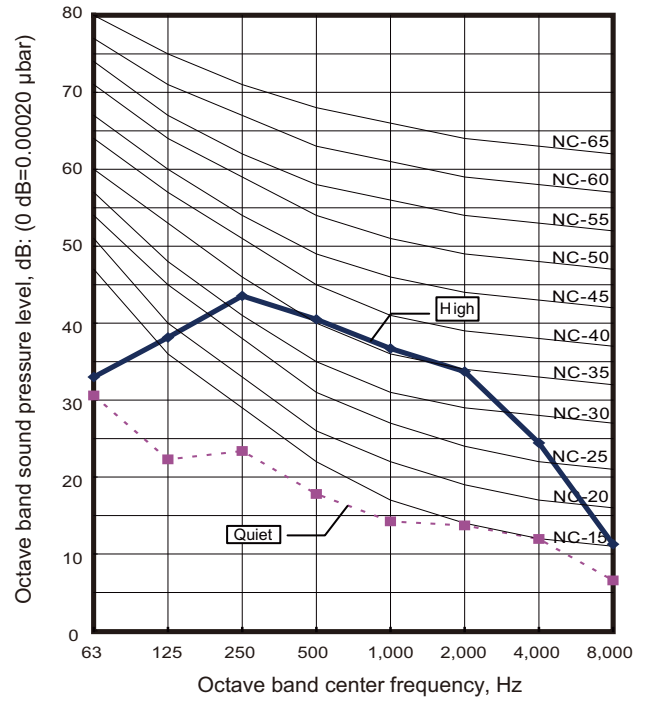

9-5. Sound level check point

■ Compact cassette type

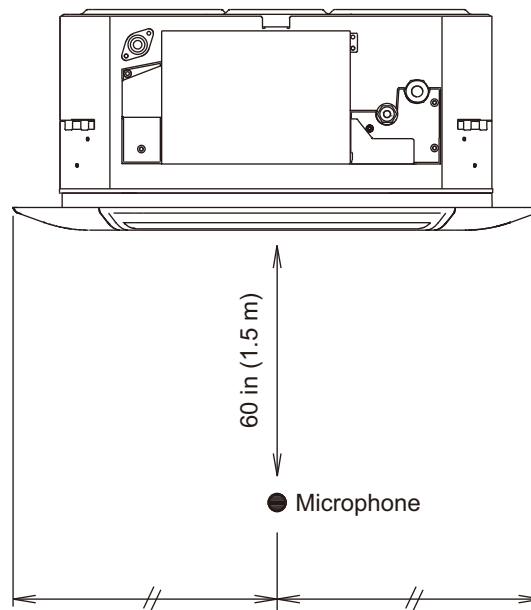
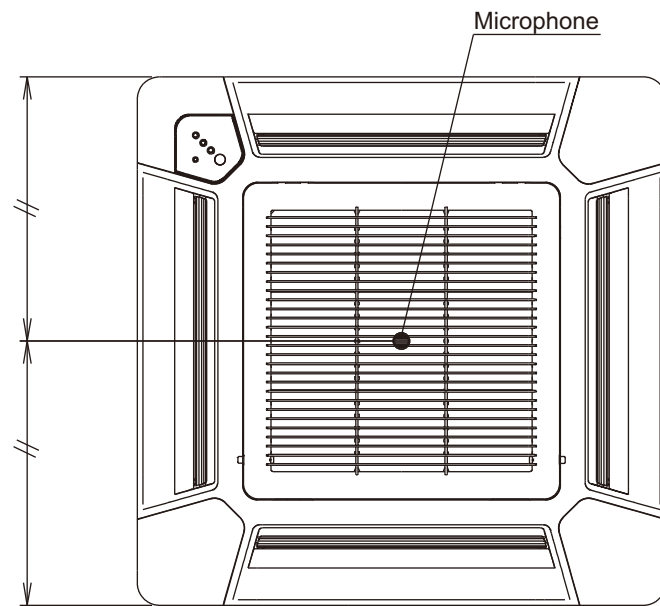

■ Slim duct type

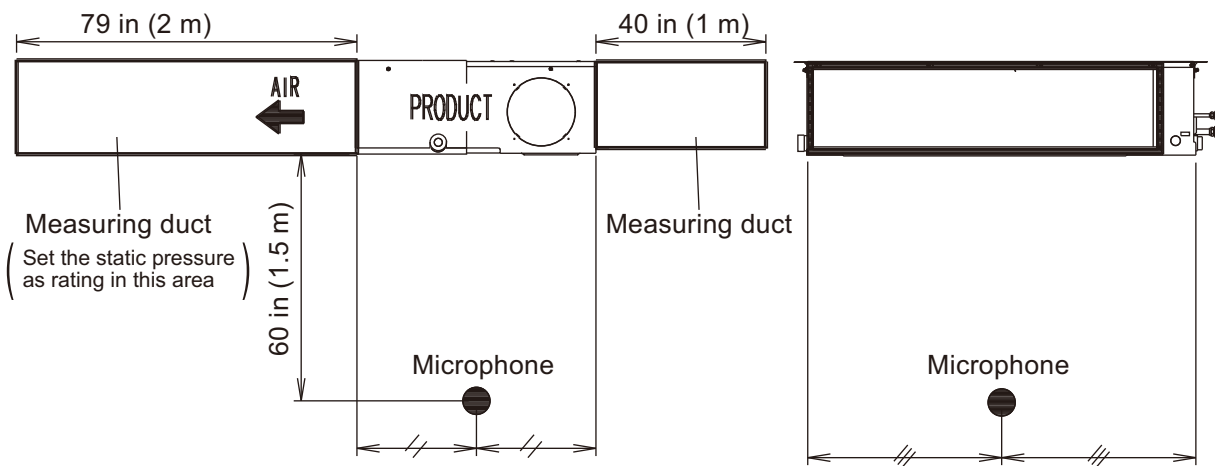

Side view

Front view

■ Wall mounted type

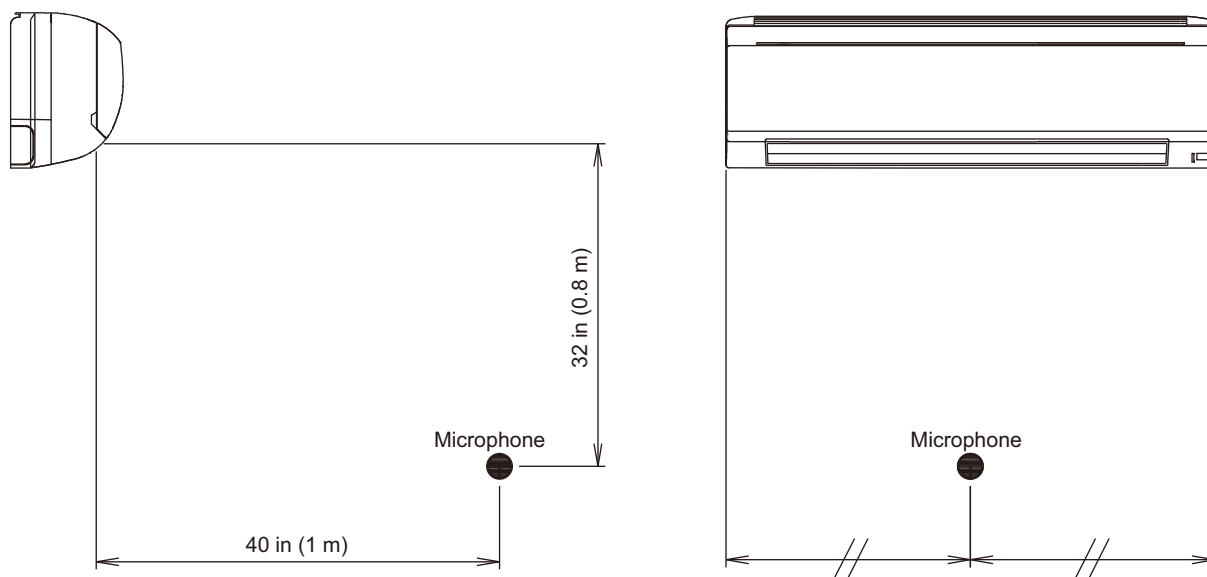

■ Floor type

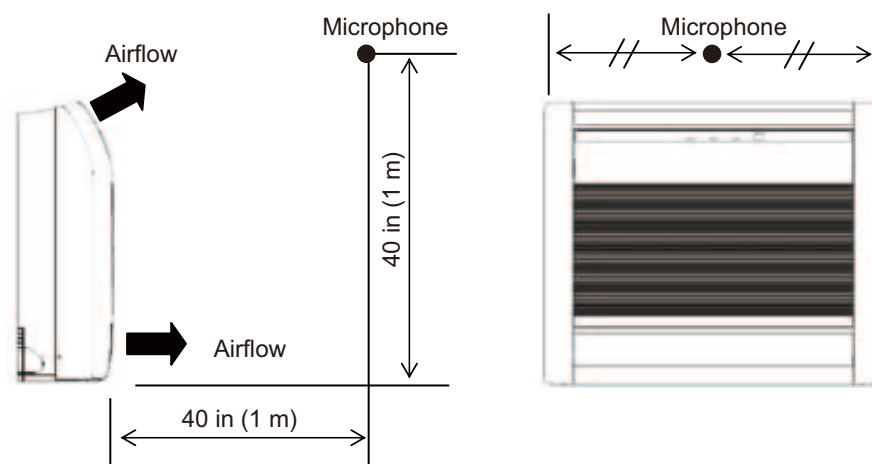

10. Electrical characteristics

Type	Model name	Hz	Power supply		Indoor rated	
			Voltage (V)	MCA (A)	Input power (W)	FLA (A)
Compact cassette	AUU7RLF	60	208 / 230	0.19 / 0.19	17 / 18	0.15 / 0.15
	AUU9RLF			0.19 / 0.19	17 / 18	0.15 / 0.15
	AUU12RLF			0.24 / 0.24	22 / 23	0.19 / 0.19
	AUU18RLF			0.41 / 0.38	38 / 39	0.32 / 0.30
Slim duct	ARU7RLF			0.40 / 0.41	47 / 33	0.32 / 0.30
	ARU9RLF			0.40 / 0.38	47 / 49	0.32 / 0.30
	ARU12RLF			0.47 / 0.44	56 / 58	0.37 / 0.35
	ARU18RLF			0.59 / 0.55	71 / 73	0.47 / 0.44
	ARU24RLF			0.89 / 0.83	109 / 111	0.71 / 0.66
Wall mounted	ASU7RLF1			0.18 / 0.16	15 / 15	0.14 / 0.13
	ASU9RLF1			0.20 / 0.19	17 / 17	0.16 / 0.15
	ASU12RLF1			0.25 / 0.24	22 / 22	0.20 / 0.19
	ASU15RLF1			0.34 / 0.31	28 / 28	0.27 / 0.25
	ASU18RLF			0.42 / 0.40	40 / 41	0.34 / 0.32
	ASU24RLF			0.71 / 0.66	68 / 69	0.57 / 0.53
Floor	AGU9RLF			0.36 / 0.33	35 / 32	0.29 / 0.26
	AGU12RLF	0.36 / 0.33	35 / 32	0.29 / 0.26		
	AGU15RLF	0.41 / 0.38	40 / 36	0.33 / 0.30		

Wiring spec. (Indoor unit to outdoor unit)	Connection cable	AWG	14
	Limited wiring length	ft (m)	85 (26)

MCA: Minimum Circuit Ampacity = Maximum operating current (Full load)

FLA: Full Load Ampacity

11. Safety devices

Indoor unit type	Model name	PCB* fuse	Fan motor thermal protector	Terminal thermal fuse	Float switch
Compact cassette	AUU7RLF AUU9RLF AUU12RLF AUU18RLF	250 V, 3.15 A	Activate: 212 ± 27 °F (100 ± 15 °C) Fan motor stop Reset: 203 ± 18 °F (95 ± 10 °C) Fan motor restart	—	○
Slim duct	ARU7RLF ARU9RLF ARU12RLF ARU18RLF ARU24RLF	250 V, 3.15 A	Activate: 275 ± 27 °F (135 ± 15 °C) Fan motor stop Reset: 239 ± 27 °F (115 ± 15 °C) Fan motor restart	—	○
Wall mounted	ASU7RLF1 ASU9RLF1 ASU12RLF1 ASU15RLF1	250 V, 3.15 A	Activate: 221 ± 18 °F (105 ± 10 °C) Fan motor stop Reset: 194 ± 18 °F (90 ± 10 °C) Fan motor restart	—	—
	ASU18RLF ASU24RLF	250 V, 3.15 A	Activate: 302 ± 27 °F (150 ± 15 °C) Fan motor stop Reset: 248 ± 27 °F (120 ± 15 °C) Fan motor restart	Activate: 216 °F (102 °C)	—
Floor	AGU9RLF AGU12RLF AGU15RLF	250 V, 3.15 A	Activate: 302 ± 27 °F (150 ± 15 °C) Fan motor stop Reset: 248 ± 27 °F (120 ± 15 °C) Fan motor restart	Activate: 216 °F (102 °C)	—

*: Printed Circuit Board

12. External input and output

Indoor unit type	External input	External output			
	Control input	Operation status output	Fresh air control output	Auxiliary heater output	Error status output
Compact cassette	•	•	•	—	—
Slim duct	•	•	•	•	—
Wall mounted	•	•	—	—	• (ASU7/9/12/ 15RLF1)
Floor	•	•	—	—	•

12-1. External input

With using external input function, some functions on this product can be controlled from an external device.

- “Operation/Stop” mode or “Forced stop” mode can be selected with function setting of indoor unit.
- A twisted pair cable (22AWG) should be used. Maximum length of cable is 492 ft (150 m).
- The wire connection should be separate from the power cable line.

■ Control input (Operation/Stop or Forced stop)

Indoor unit type		Connector
Compact cassette		CN102
Slim duct		CN102
Wall mounted	ASU7RLF1, ASU9RLF1, ASU12RLF1, ASU15RLF1	CNA01
	ASU18RLF, ASU24RLF	CN14
Floor	AGU9RLF, AGU12RLF, AGU15RLF	CN14

The air conditioner can be remotely operated by means of the following on-site work.

Operation is started at the following contents by adding the contact input of a commercial on/off switch to a connector on the external control PCB and turning it on.

Unit operation	Initial setting after power is on	Starting mode other than initial setting
Operation mode	Auto changeover	Mode at previous operation
Set temperature	76 °F (24 °C)	Temperature at previous operation
Airflow mode	AUTO	Mode at previous operation
Air direction (swing)	Standard air direction (swing: off)	Air direction at previous operation

● Circuit diagram example

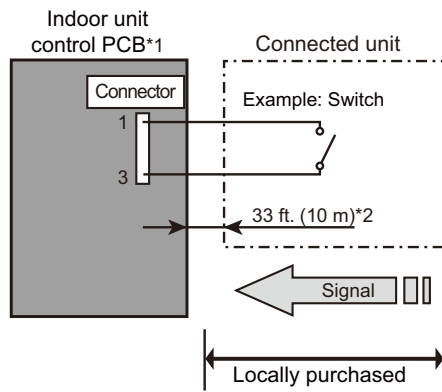

- Contact capacity: DC 24 V or more, 10 mA or more.
- *1: PCB of Communication kit is used for wall mounted (ASU7RLF1, ASU9RLF1, and ASU12RLF1) type.
- *2: Make the distance from the PCB to the connected unit within 33 ft (10 m).
- Use non-polar relays and switches.

Indoor unit type		1-pin (Polarity)	3-pin (Polarity)
Compact cassette		-	+
Slim duct		-	+
Wall mounted	ASU7RLF1, ASU9RLF1, ASU12RLF1, ASU15RLF1 ASU18RLF, ASU24RLF	-	+
Floor	AGU9RLF, AGU12RLF, AGU15RLF	-	+

- When function setting is "Operation/Stop" mode

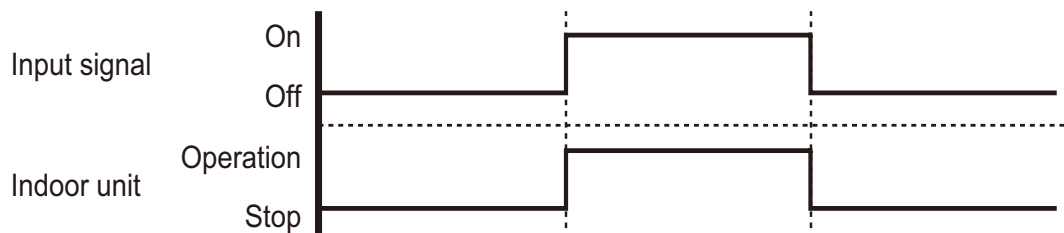

- When function setting is "Forced stop" mode

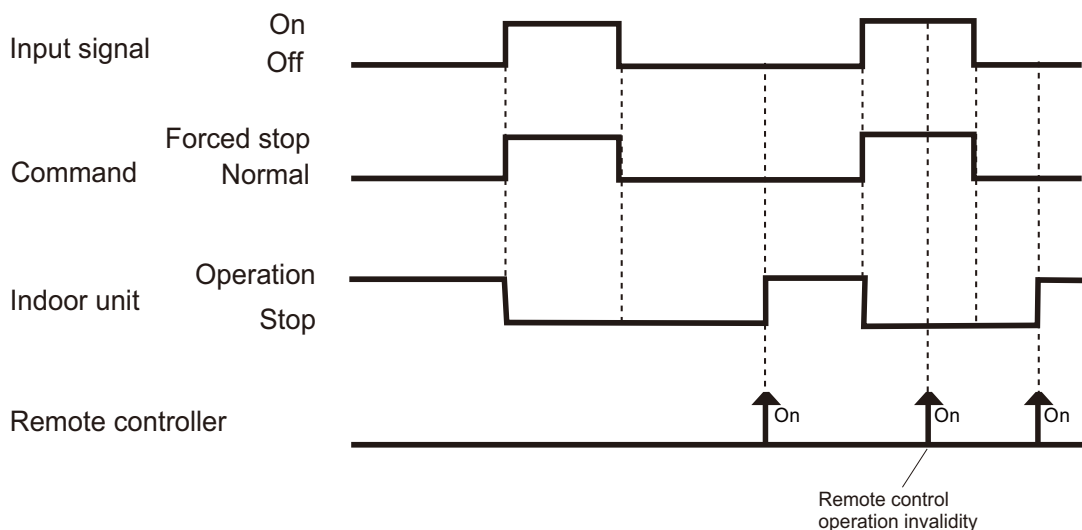

● Optional part

Indoor unit type		Parts name	Model name
Compact cassette		External connect kit	UTY-XWZX
Slim duct			UTD-ECS5A
Wall mounted	ASU7RLF1, ASU9RLF1, ASU12RLF1, ASU15RLF1		UTY-XWZXZ5
	ASU18RLF, ASU24RLF		UTY-XWZX
Floor	AGU9RLF, AGU12RLF, AGU15RLF	UTY-XWZXZ5	

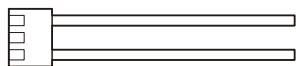

UTY-XWZX



UTD-ECS5A

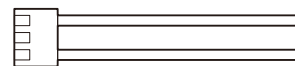

UTY-XWZXZ5

Indoor unit type		Parts name	Model name
Compact cassette		—	—
Slim duct		—	—
Wall mounted	ASU7RLF1, ASU9RLF1, ASU12RLF1, ASU15RLF1	Communication kit	UTY-XCBXZ2
	ASU18RLF, ASU24RLF	—	—
Floor	AGU9RLF, AGU12RLF, AGU15RLF	—	—

*For operating the external input function, the wall mounted type (ASU7RLF1, ASU9RLF1, ASU12RLF1, and ASU15RLF1) requires optional communication kit (UTY-XCBXZ2) in addition to the wire (UTY-XWZXZ5).

12-2. External output

Use an external output cable with appropriate external dimension, depending on the number of cables to be installed.

■ Operation status output

Indoor unit type		Connector
Compact cassette		CN103
Slim duct		CN103
Wall mounted	ASU7RLF1, ASU9RLF1, ASU12RLF1, ASU15RLF1	CNB01
	ASU18RLF, ASU24RLF	CN16
Floor	AGU9RLF, AGU12RLF, AGU15RLF	CN20

Air conditioner operation status signal can be output.

● Circuit diagram example

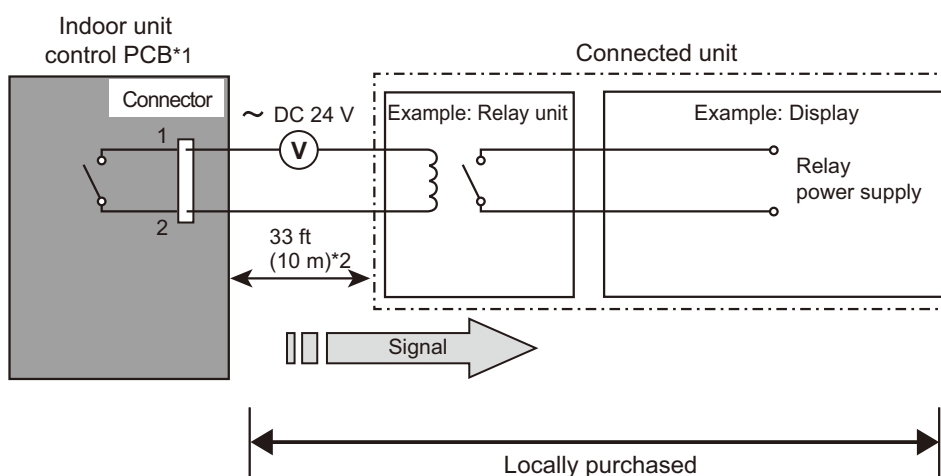

- *1: PCB of Communication kit is used for wall mounted type(ASU7RLF1, ASU9RLF1, ASU12RLF1, and ASU15RLF1).
- *2: Make the distance from the PCB to the connected unit within 33 ft (10 m).
- Relay spec: Max. DC 24 V, 10 mA to less than 500 mA.

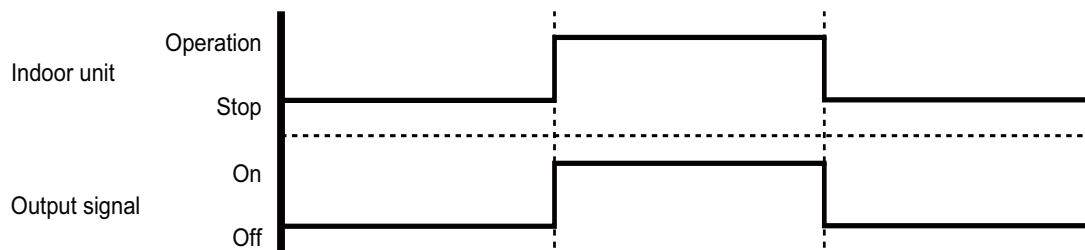

● Optional part

Indoor unit type		Parts name	Model name
Compact cassette		External connect kit	UTY-XWZX
Slim duct			UTD-ECS5A
Wall mounted	ASU7RLF1, ASU9RLF1, ASU12RLF1, ASU15RLF1		UTY-XWZXZ5
	ASU18RLF, ASU24RLF		UTY-XWZX
Floor	AGU9RLF, AGU12RLF, AGU15RLF		UTY-XWZXZ5



Indoor unit type		Parts name	Model name
Compact cassette		—	—
Slim duct		—	—
Wall mounted	ASU7RLF1, ASU9RLF1, ASU12RLF1, ASU15RLF1	Communication kit	UTY-XCBXZ2
	ASU18RLF, ASU24RLF	—	—
Floor	AGU9RLF, AGU12RLF, AGU15RLF	—	—

*For operating the external output function, the wall mounted type (ASU7RLF1, ASU9RLF1, ASU12RLF1, and ASU15RLF1) requires optional Communication kit (UTY-XCBXZ2) in addition to the wire (UTY-XWZXZ5).

■ Fresh air control output

Indoor unit type	Connector
Compact cassette	CN6
Slim duct	CN6
Wall mounted	—
Floor	

Signal linked to air conditioner indoor fan on can be output.

* However, signal becomes off during cold air prevention control operation.

● Circuit diagram example

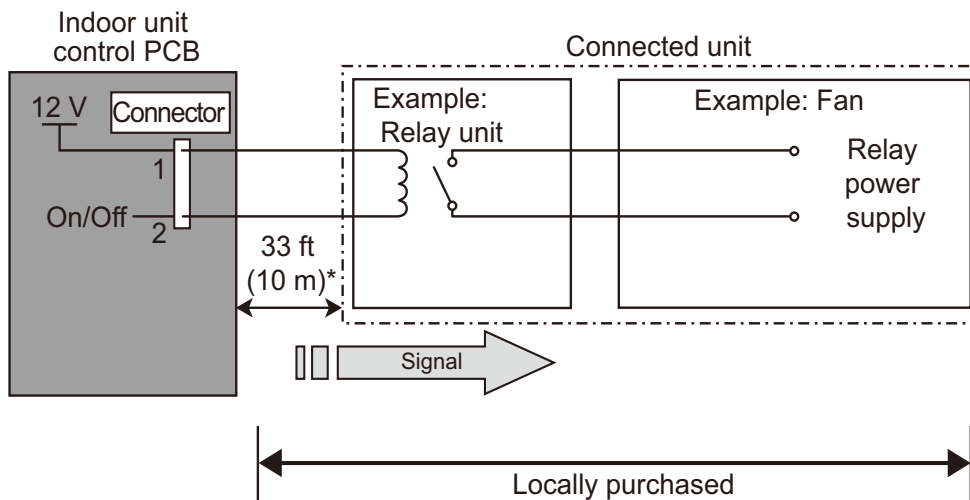

- *: Make the distance from the PCB to the connected unit within 33 ft (10 m).

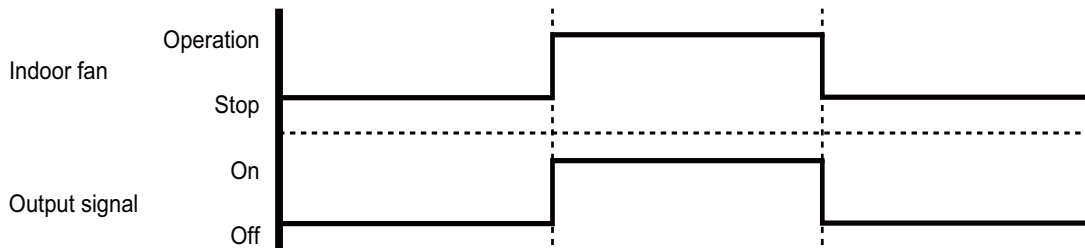

● Optional part

Indoor unit type	Parts name	Model name
Compact cassette	Fresh air intake kit	UTZ-VXAA
Slim duct	External control set	UTD-ECS5A
Wall mounted	—	—
Floor	—	—



■ Auxiliary heater output

Indoor unit type	Connector
Compact cassette	—
Slim duct	CN10
Wall mounted	—
Floor	

Signal is output from connector when indoor fan and compressor turn on under heating operation.

*Signal output performance specifications are as shown as follows:

Example: When Set Temperature (T_s) is 72 °F(22 °C)

- and room temperature (T_r) increase above 52 °F(12 °C), signal output is on.
- and room temperature (T_r) increase above 70 °F(21 °C), signal output is off.
- and room temperature (T_r) decrease below 66 °F(19 °C), signal output is on.
- and room temperature (T_r) decrease below 48 °F(10 °C), signal output is off.

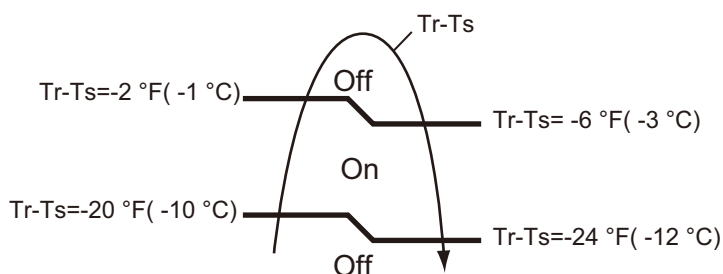

● Fan delay setting (JM3)

This is used to continue indoor unit fan operation for 1 minute after thermostat "Off" in heating mode.

1 minute delay control set by cutting jumper wire on PCB.

● Circuit diagram example

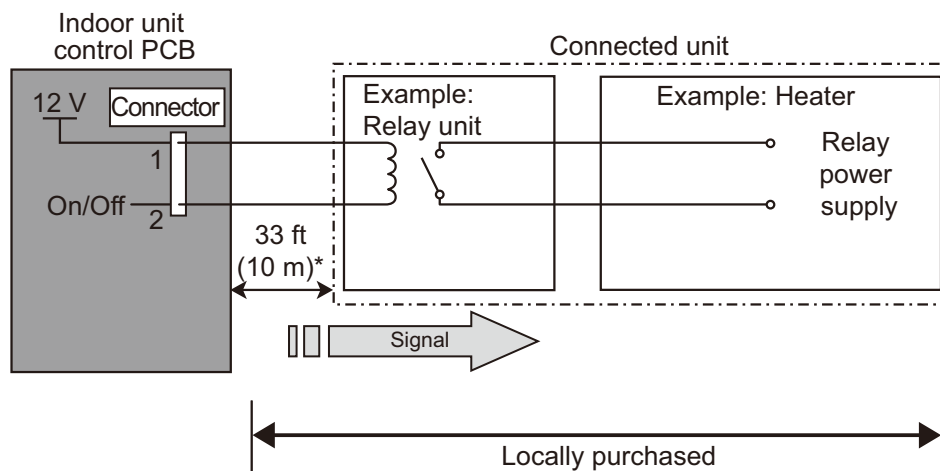

- Relay spec.: Rated DC 12 V, 50 mA to less.
- *: Make the distance from the PCB to the connected unit within 33 ft (10 m).

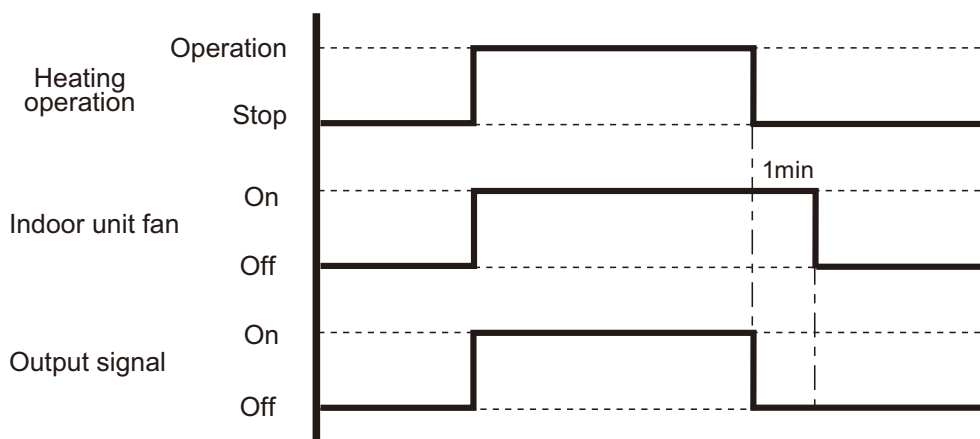

⚠ CAUTION

- Locate an external heater between the indoor unit and the outlet.

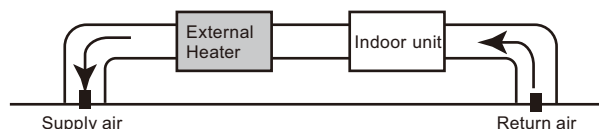

- Be sure to use delay control of a fan.

● Optional part

Indoor unit type	Parts name	Model name
Compact cassette	—	—
Slim duct	External control set	UTD-ECS5A
Wall mounted	—	—
Floor	—	—



■ Error status output

Indoor unit type		Connector
Compact cassette		—
Slim duct		—
Wall mounted	ASU7RLF1, ASU9RLF1, ASU12RLF1, ASU15RLF1	CNB02
	ASU18RLF, ASU24RLF	—
Floor	AGU9RLF, AGU12RLF, AGU15RLF	CN21

An air conditioner error status signal can be output.

● Circuit diagram example

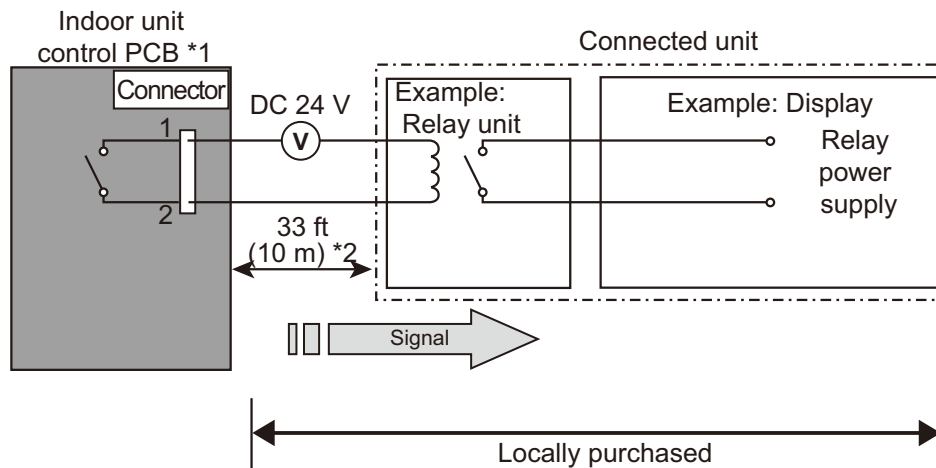

- *1: PCB of Communication kit is used for wall mounted type (ASU7RLF1, ASU9RLF1, ASU12RLF1, and ASU15RLF1).
- *2: Make the distance from the PCB to the connected unit within 33 ft (10 m).
- Relay spec.: Rated DC 12 V, 50 mA to less.

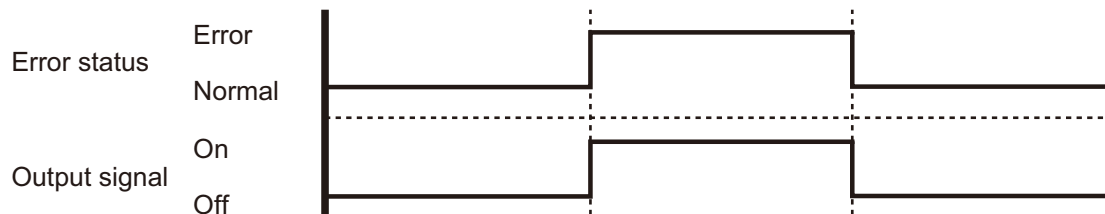

● Optional part

Indoor unit type		Parts name	Model name
Compact cassette		—	—
Slim duct		—	—
Wall mounted	ASU7RLF1, ASU9RLF1, ASU12RLF1, ASU15RLF1	External connect kit	UTY-XWZXZ5
	ASU18RLF, ASU24RLF	—	—
Floor	AGU9RLF, AGU12RLF, AGU15RLF	External connect kit	UTY-XWZXZ5



Indoor unit type		Parts name	Model name
Compact cassette		—	—
Slim duct		—	—
Wall mounted	ASU7RLF1, ASU9RLF1, ASU12RLF1, ASU15RLF1	Communication kit	UTY-XCBXZ2
	ASU18RLF, ASU24RLF	—	—
Floor	AGU9RLF, AGU12RLF, AGU15RLF	—	—

*For operating the external input function, the wall mounted type (ASU7RLF1, ASU9RLF1, ASU12RLF1, and ASU15RLF1) requires Communication kit (UTY-XCBXZ2) in addition to the wire (UTY-XWZXZ5).

13. Function settings

To adjust the functions of this product according to the installation environment, various types of function settings are available.

NOTE: Incorrect settings can cause a product malfunction.

13-1. Indoor unit (setting by jumper wire)

NOTE: This setting is necessary only for slim duct type.

■ Component location

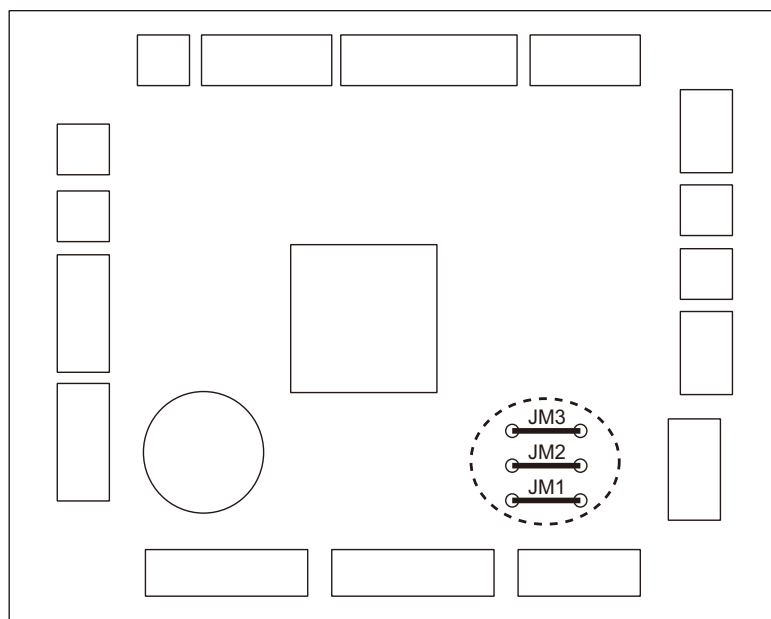

■ Jumper wire setting

● Drainage function setting (JM1)

JM1	Function	Factory setting
Connect	Enable	◆
Disconnect	Disable	

● Auto louver grille setting (JM2)

When optional Auto louver grille kit is attached, set this setting to "Valid".

JM2	Function	Factory setting
Connect	Disable	◆
Disconnect	Enable	

● Fan delay setting (JM3)

JM3	Function	Factory setting
Connect	Disable	◆
Disconnect	Enable	

13-2. Indoor unit (setting by wireless remote controller)

- The function settings of the control of the indoor unit can be changed by this procedure according to the installation conditions. Incorrect settings can cause the indoor unit malfunction.
- After the power is turned on, perform the “Function setting” according to the installation conditions using the remote controller.
- The settings may be selected between the following two: function number or setting number.
- Settings will not be changed if invalid numbers or setting numbers are selected.

■ Preparation

Before connecting the power supply of the indoor unit, reconfirm following items:

- Piping air tight test and vacuuming have been performed firmly.
- There is no wiring mistake. Then, connect the power supply of the indoor unit.

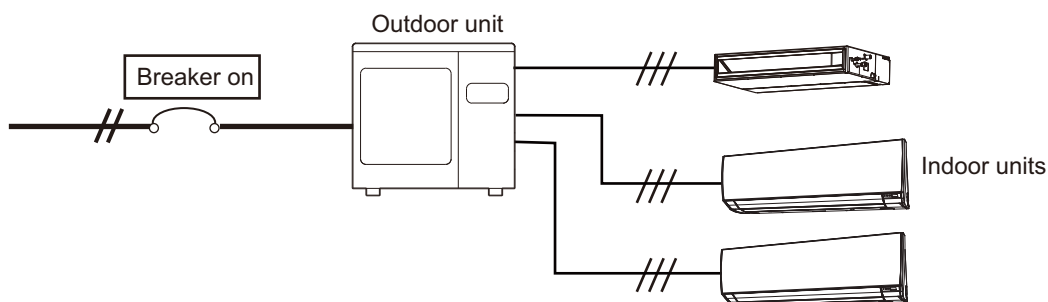

■ UTY-LNHUM

● Button name and function

During address setting mode, indoor unit reject the any operation command from remote controller.

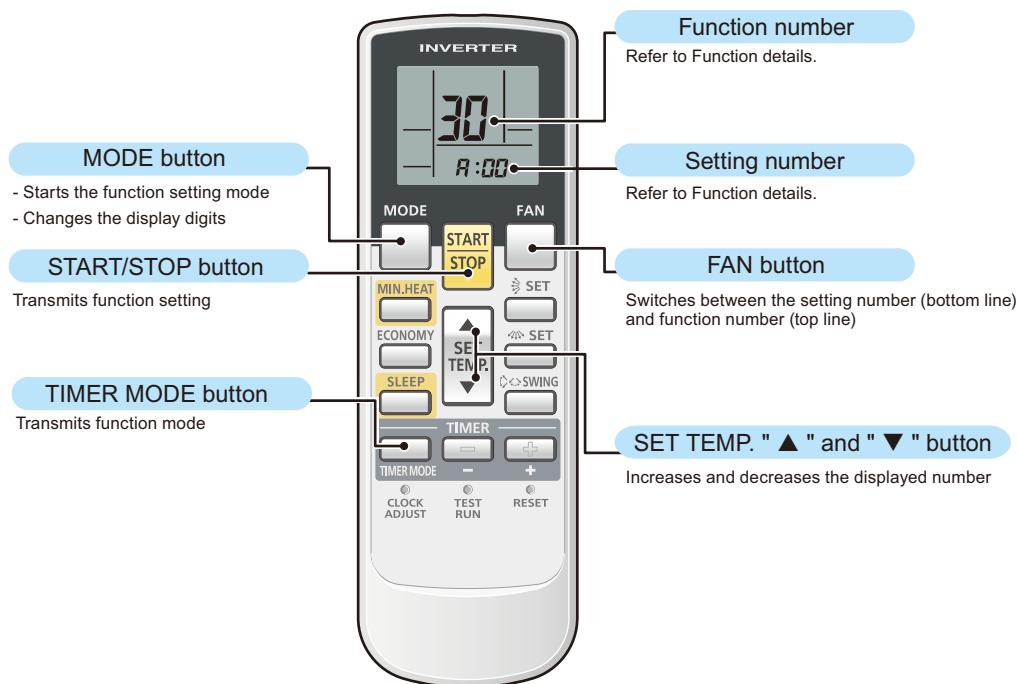

● Function setting procedure

1. Connect the power supply of the outdoor unit.
2. To enter the function setting mode, while holding down the FAN and the SET TEMP. ▲ buttons, press the RESET button.

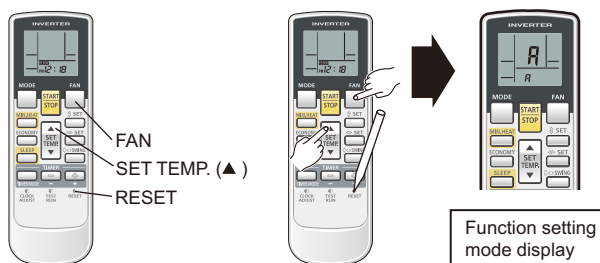

3. Press the SET TEMP. ▲ or ▼ buttons to select the custom code that matches the setting with the indoor unit. By selecting the appropriate custom code, the communication between the indoor unit and the wireless remote controller become possible.

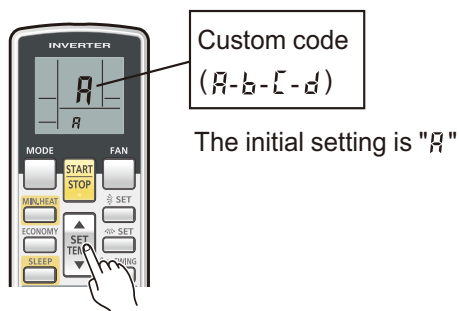

- For confirming the custom code, press the TIMER MODE button to send the code to the indoor unit.

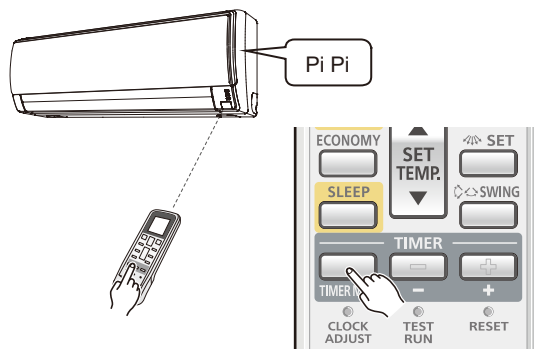

- Press the MODE button to enter the function setting mode.

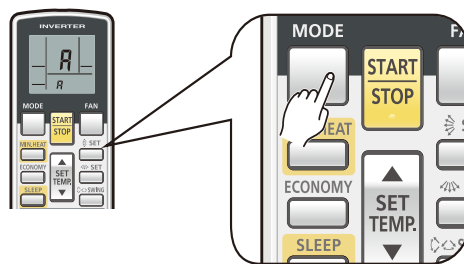

- Select the function number by pressing the ▲ or the ▼ button. Each time the MODE button is pressed, it switches between the left digit and the right digit.

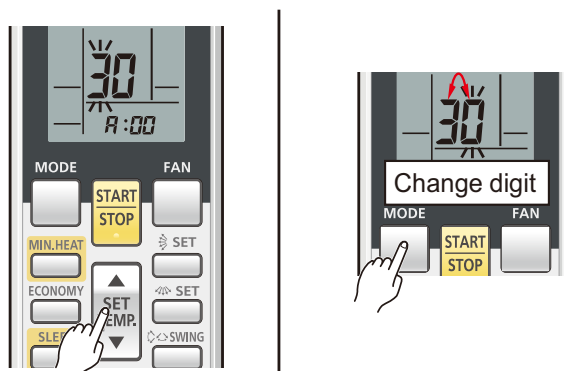

- Proceed to number setting by pressing the FAN button. To return to the function number selection, press the FAN button again.



8. Select the setting number by pressing the ▲ or the ▼ button.
Each time the MODE button is pressed, it switches between the left digit and the right digit.

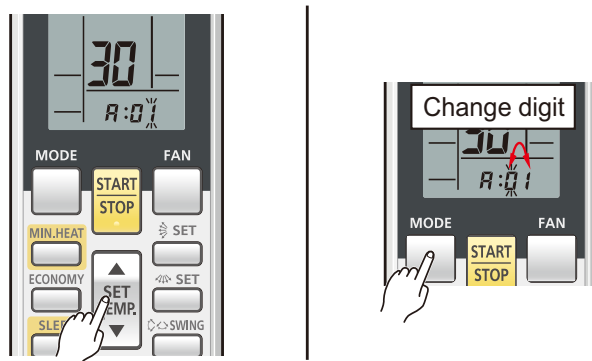

9. Send the function mode information by pressing the TIMER MODE button once.

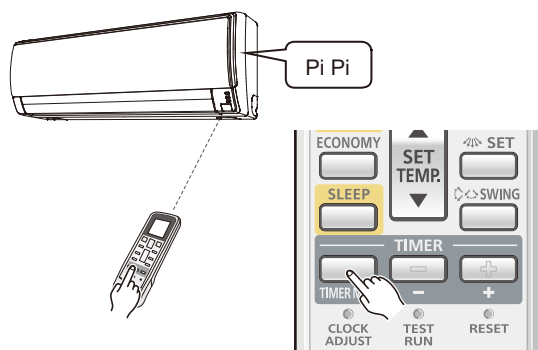

10. Send the function setting information by pressing the START/STOP button once.
2 short beeps will be emitted from the indoor unit when the signal is received correctly. If wrong code is set, no beep sound will be emitted.

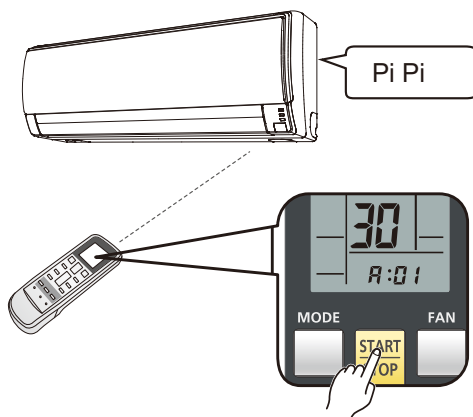

NOTE: Press START/STOP button within 30 seconds after pressing TIMER MODE button.

Function details: Refer to Chapter 13-5. ["Function details"](#) on page 149.

11. Exit the function setting mode by pressing the RESET button.

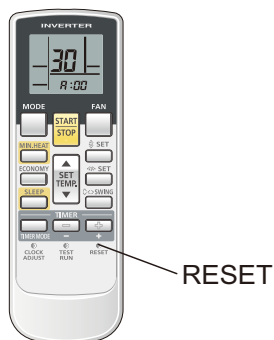

To set custom code b , c , or d , perform same procedures for each code.

● Setting up each indoor unit

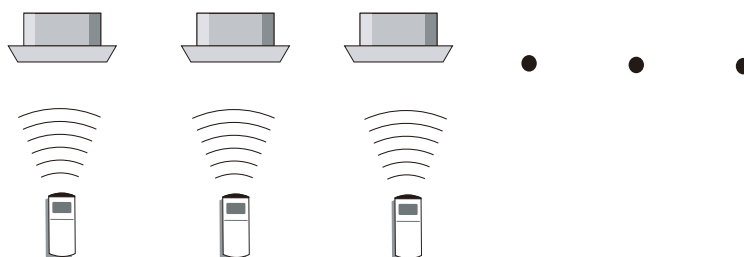

Repeat step from 1. to 11. to set up each indoor unit. If the custom code is other than " H ", steps from 1. to 4. and 11. need to be performed.

● Resetting the power after setting up function of all indoor units

NOTES:

- If the reset is not performed, function can not be read correctly.
- After all the functions have been set, the circuit breaker needs to be switched off for at least 2 minutes.
 - After the 2 minutes has passed, power can be restored.
 - The set function is stored in the PCB and will remain in memory even when the power of indoor unit is turned off.
However setting function is effective after disconnecting the power supply and then reconnecting it.
- Record the latest configuration of the indoor unit function setting on a label, and put the label on the unit so it can be used for after-sales service operations.

Once the RESET button is pressed on the remote controller, the operation mode will be set to the AUTO MODE.

Adjust the operation mode to either cooling or heating before starting the operation of the air conditioner.

NOTE: If custom code other than " H " is set, the remote control must be set accordingly to the indoor unit setting.

● Remote controller custom code setting

Custom code setting of wireless remote controller needs to be same as the setting of the indoor unit. When you change the custom code setting of the wireless remote controller, do as follows:

1. Press the START/STOP button until only the clock is displayed on the remote controller display.

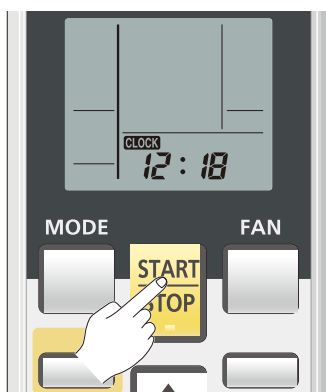

2. Press the MODE button for at least 5 seconds to display the current custom code (initially set to A).

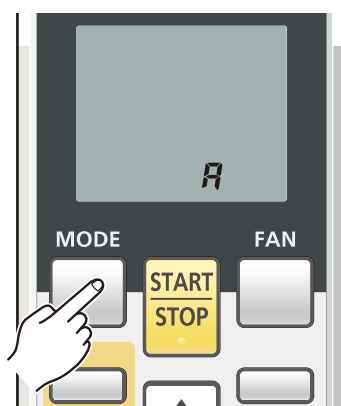

3. Press the SET TEMP. ▲ or the ▼ button to change the custom code between A → b → c → d.



4. Press the MODE button again to return to the clock display. The custom code will be changed.

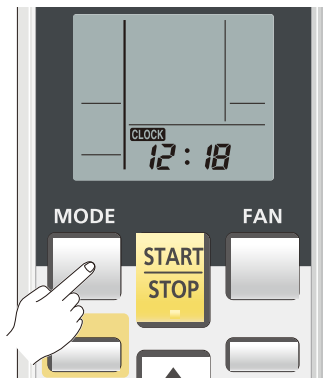

- If no buttons are pressed within 30 seconds after the custom code is displayed, the system returns to the original clock display. In this case, start again from step 1.
- The air conditioner custom code is set to A prior to shipment.
- The remote controller resets to custom code A when the batteries in the remote controller are replaced. If you use a custom code other than custom code A, reset the custom code after replacing the batteries. If you do not know the air conditioner custom code setting, try each of the custom codes (a → b → c → d) until you find the code which operates the air conditioner.

AR-REG1U

● Button name and function

During address setting mode, indoor unit reject the any operation command from remote controller.

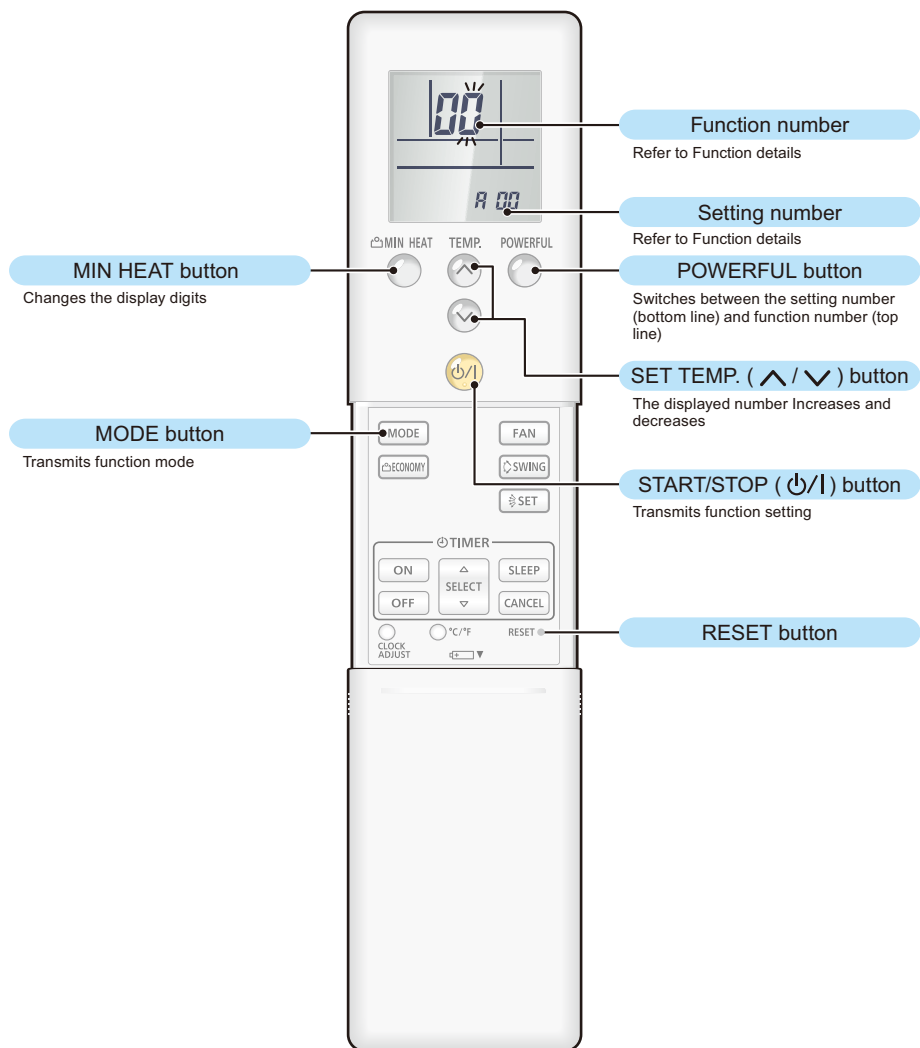

● Function setting procedure

1. Connect the power supply of the outdoor unit.
2. To enter the function setting mode, while holding down the POWERFUL and SET TEMP. ^ buttons, press the RESET button.

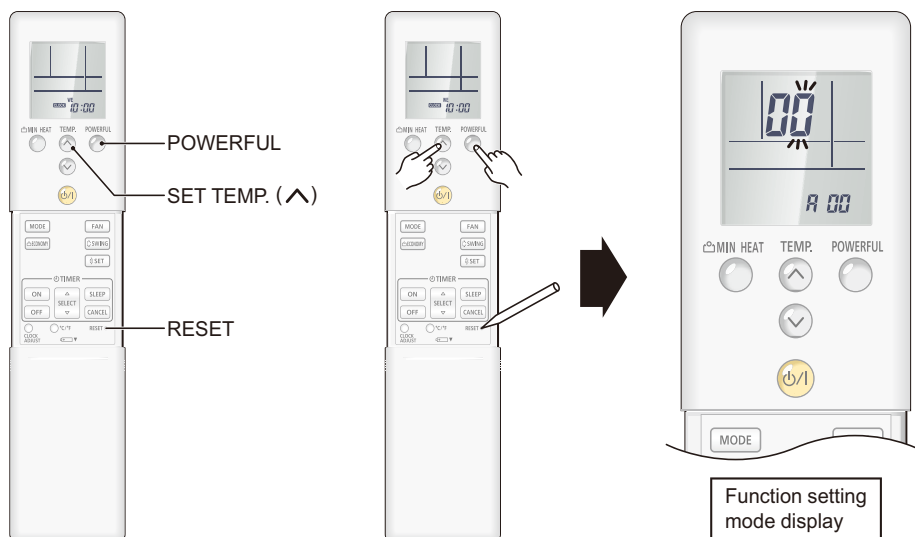

3. Select the function number by pressing the \wedge or the \vee buttons. Each time the MIN. HEAT button is pressed, it switches between the right digit and the left digit.

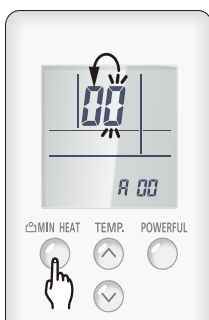

Change digit

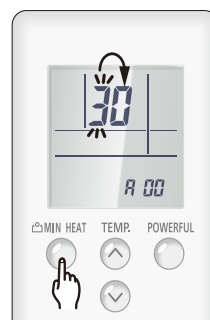
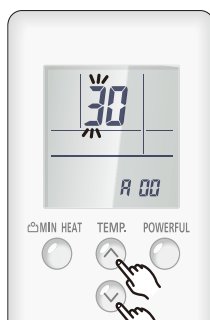

Change digit

4. Proceed to the setting number by pressing the POWERFUL button. (To return to the function number selection, press the POWERFUL button again.)



5. Select the function number by pressing the \wedge or the \vee button. Each time the MIN. HEAT button is pressed, it switches between the right digit and the left digit.

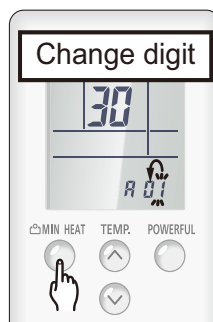
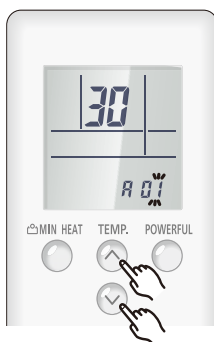

- Press the MODE button once to transmit the function mode information.

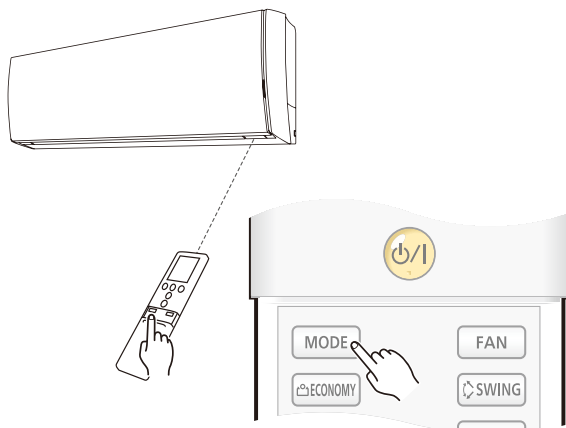

- Press the ϕ/I button once to transmit the function setting information. 2 short beeps will be emitted from the indoor unit when the signal is received correctly. If wrong code is set, no beep sound will be emitted.

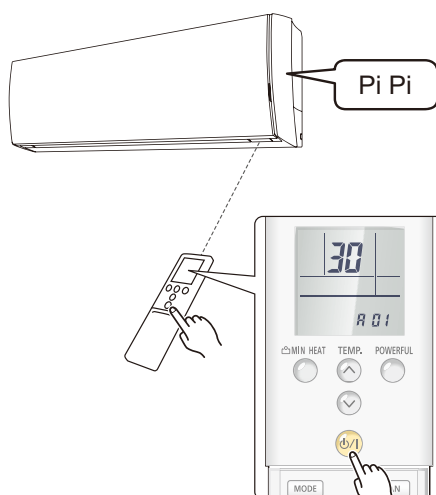

NOTE: Press ϕ/I button within 30 seconds after pressing MODE button.

For the function details, refer to Chapter 13-5. "[Function details](#)" on page 149.

- Exit the function setting mode by pressing the RESET button.

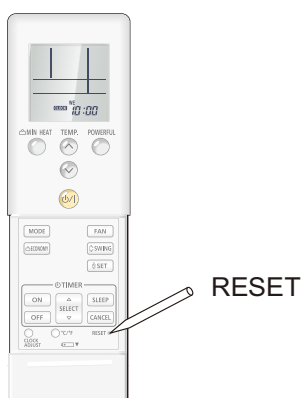

● Setting up each indoor unit

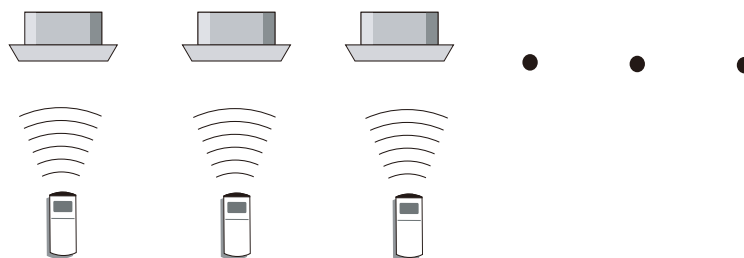

Repeat step from 1. to 8. to set up each indoor unit. If the custom code is other than "F", steps from 1. to 2. and 8. need to be performed.

● Resetting the power after setting up function of all indoor units

NOTES:

- If the reset is not performed, function can not be read correctly.
- After all the functions have been set, the circuit breaker needs to be switched off for at least 2 minutes.
 - After the 2 minutes has passed, power can be restored.
 - The set function is stored in the PCB and will remain in memory even when the power of indoor unit is turned off. However setting function is effective after disconnecting the power supply and then reconnecting it.
- Record the latest configuration of the indoor unit function setting on a label, and put the label on the unit so it can be used for after-sales service operations.

Once the RESET button is pressed on the remote controller, the operation mode will be set to the AUTO MODE.

Adjust the operation mode to either cooling or heating before starting the operation of the air conditioner.

NOTE: If custom code other than "F" is set, the remote control must be set accordingly to the indoor unit setting.

● Remote controller custom code setting

Custom code setting of wireless remote controller needs to be same as the setting of the indoor unit. When you change the custom code setting of the wireless remote controller, do as follows:

1. Press the START/STOP button until only the clock is displayed on the remote controller display.



2. Press the MODE button for at least 5 seconds to display the current custom code (initially set to A).



3. Press the SET TEMP. “^” or the “v” button to change the custom code between A → b → c → d.



4. Press the MODE button again to return to the clock display. The custom code will be changed.



- If no buttons are pressed within 30 seconds after the custom code is displayed, the system returns to the original clock display. In this case, start again from step 1.
- The air conditioner custom code is set to A prior to shipment.
- If you do not know the air conditioner custom code setting, try each of the custom codes (A → B → C → D) until you find the code which operates the air conditioner.

● Remote controller temperature unit

To change the displayed temperature unit, press the "°C/°F" switching button to select the preferred temperature unit. (Factory setting is set to "°F".):

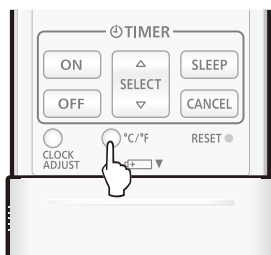

13-3. Indoor unit (setting by wired remote controller)

- The function settings of the control of the indoor unit can be changed by this procedure according to the installation conditions. Incorrect settings can cause the indoor unit malfunction.
- After the power is turned on, perform the “FUNCTION SETTING” according to the installation conditions using the remote controller.
- The settings may be selected between the following two: Function Number or Setting Number.
- Settings will not be changed if invalid numbers or setting numbers are selected.
- This function cannot be used on the secondary units.

■ Preparation

Before connecting the power supply of the indoor unit, reconfirm following items:

- Piping air tight test and vacuuming have been performed firmly.
- There is no wiring mistake. Then, connect the power supply of the indoor unit.

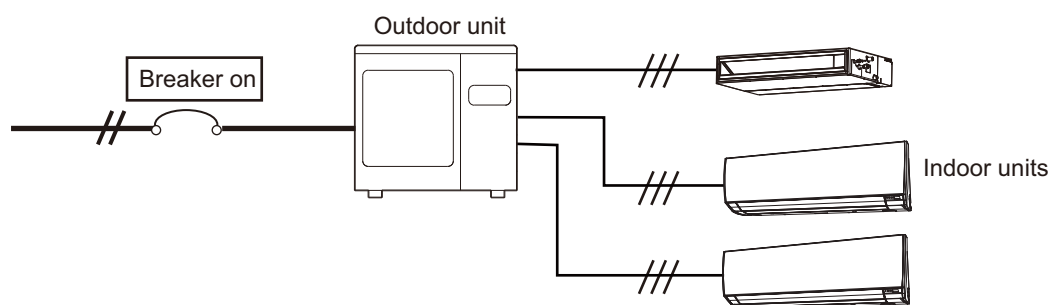

■ UTY-RNNUM

● Button name and function

During address setting mode, indoor unit reject the any operation command from remote controller.

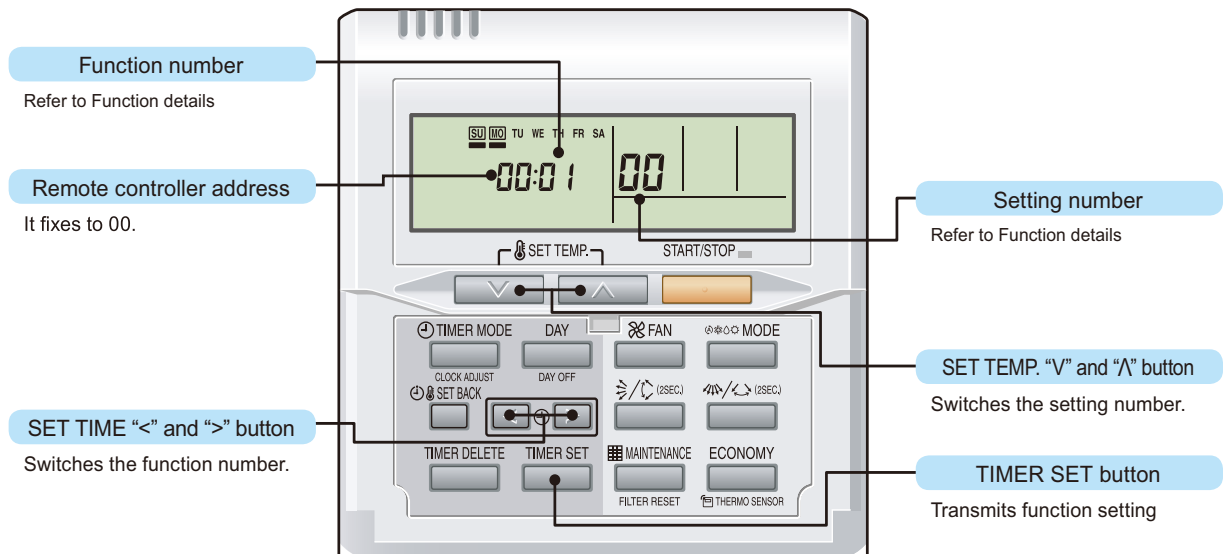

● Function setting procedure

1. Connect the power supply of the outdoor unit.
2. Switch to the function setting mode.
To enter the function setting mode, hold down the 3 buttons of SET TEMP. ∨, SET TEMP. Λ, and FAN at the same time for 5 seconds or longer.

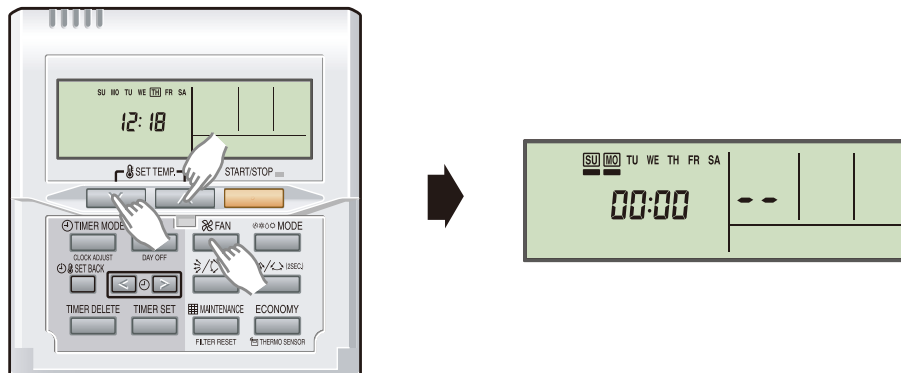

3. Select the function number by pressing the SET TIME < or the SET TIME > button.

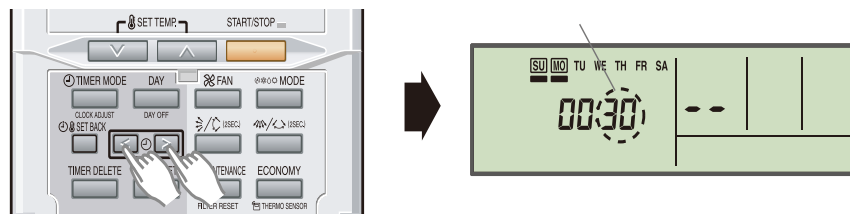

4. Select the setting number by pressing the SET TEMP. Λ or the SET TEMP. ∨ button. The display flashes during setting number selection.

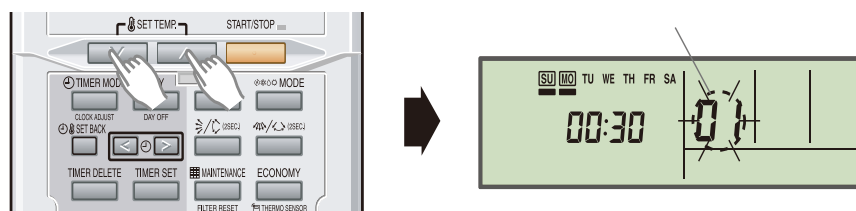

5. Confirm the setting by pressing the TIMER SET button. The data will be transferred to the indoor unit.

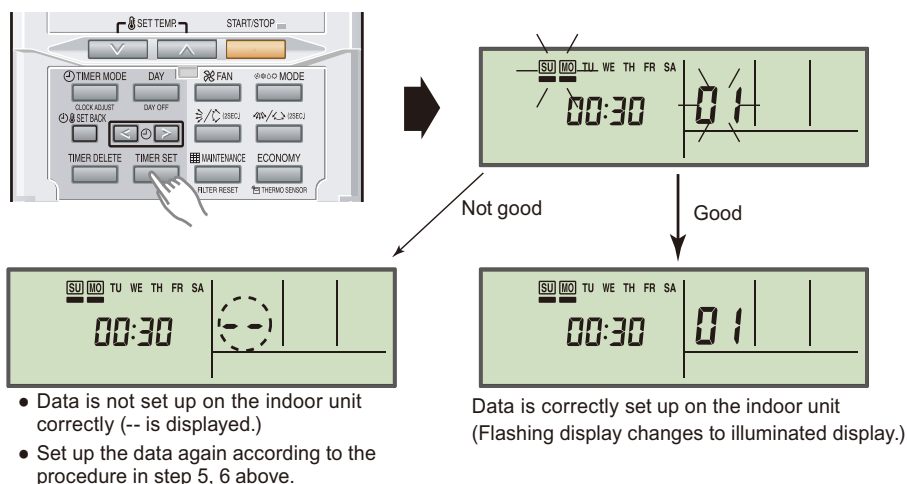

Function details: Refer to Chapter 13-5. "Function details" on page 149.

6. Exit the function setting mode by holding 3 buttons of SET TEMP. ∇ , SET TEMP. \blacktriangle and FAN at the same time.

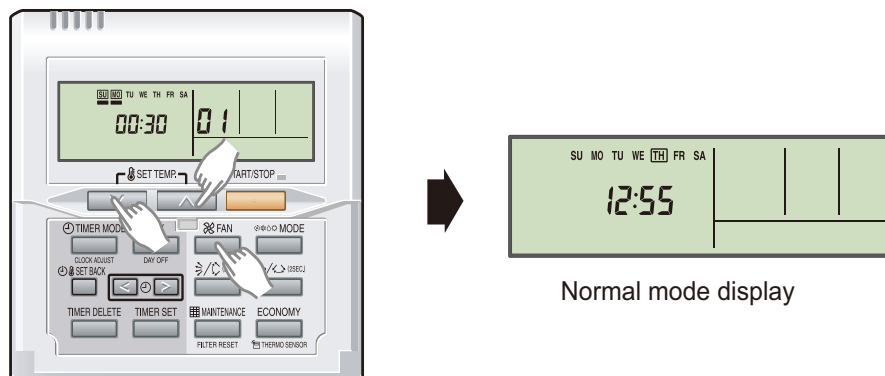

If no button is pressed within 60 seconds after buttons mentioned above are pressed, it will automatically exit the function setting mode.

If you exit the function setting mode unintentionally during setting, enter the mode again according to the procedure in step 2.

● Setting up each indoor unit

Repeat the procedures from step 1 to 6, and set up the indoor units requiring function setting.

● Resetting the power after setting up function of all indoor units

NOTES:

- If the reset is not performed, function can not be read correctly.
- After all the functions have been set, the circuit breaker needs to be switched off for at least 2 minutes.
 - After the 2 minutes has passed, power can be restored.
 - The set function is stored in the PCB and will remain in memory even when the power of indoor unit is turned off. However setting function is effective after disconnecting the power supply and then reconnecting it.
- Record the latest configuration of the indoor unit function setting on a label, and put the label on the unit so it can be used for after-sales service operations.

13-4. Indoor unit (setting by simple remote controller)

- The function settings of the control of the indoor unit can be changed by this procedure according to the installation conditions. Incorrect settings can cause the indoor unit malfunction.
- After the power is turned on, perform the “FUNCTION SETTING” according to the installation conditions using the remote controller.
- The settings may be selected between the following two: Function Number or Setting Number.
- Settings will not be changed if invalid numbers or setting numbers are selected.
- This function cannot be used on the secondary units.

■ Preparation

Before connecting the power supply of the indoor unit, reconfirm following items:

- Piping air tight test and vacuuming have been performed firmly.
- There is no wiring mistake. Then, connect the power supply of the indoor unit.

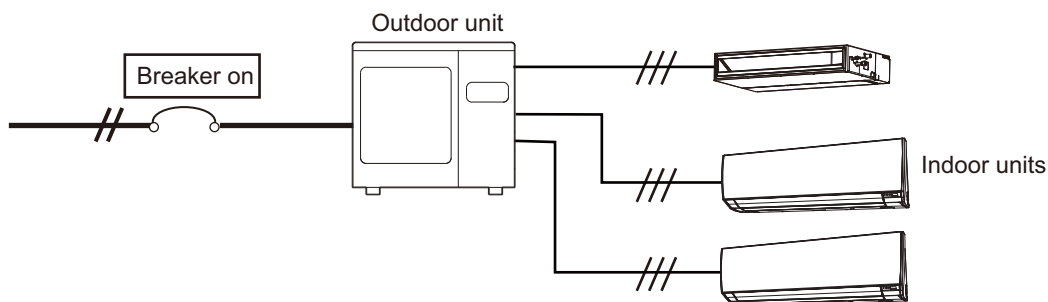

■ UTY-RSNUM

● Button name and function

During address setting mode, indoor unit reject the any operation command from remote controller.

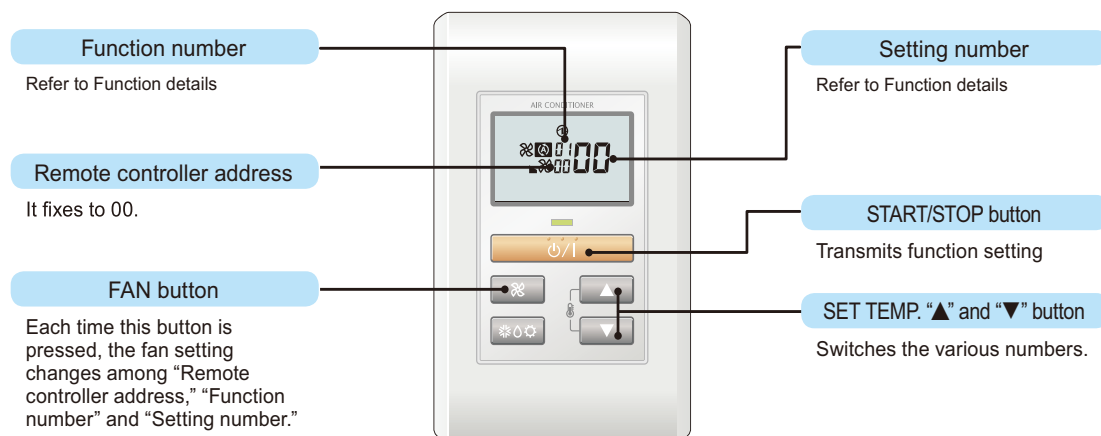

● Function setting procedure

1. Connect the power supply of the outdoor unit.

2. Switch to the function setting mode.

To enter the function setting mode, hold down the 3 buttons of SET TEMP. ▲, SET TEMP. ▼ and FAN at the same time for 5 seconds or longer.

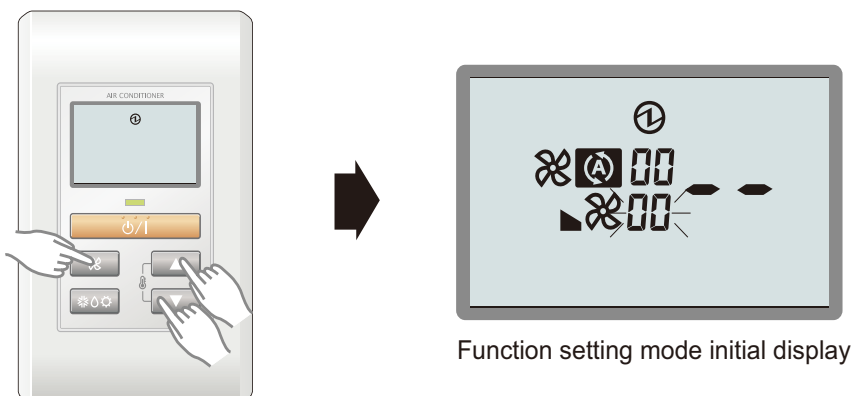

3. Press the FAN button.

The Function number indicator flashes. Then, press either the SET TEMP. ▲ button or the SET TEMP. ▼ button to set up the function number.

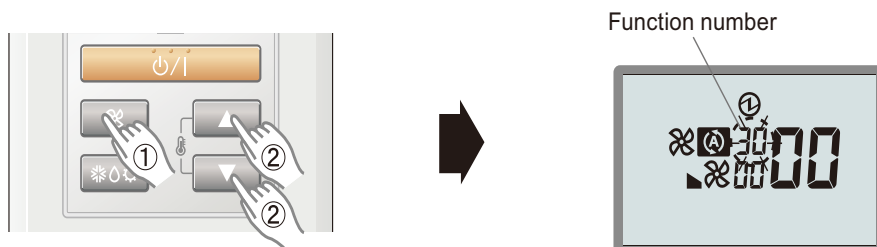

4. Select the setting number by pressing the SET TEMP. ▲ or SET TEMP. ▼ button. The setting number indicator flashes during setting number selection.



Example) Function number : 30, Setting number : 01

5. Confirm the setting by pressing the TIMER SET button. The data will be transferred to the indoor unit.

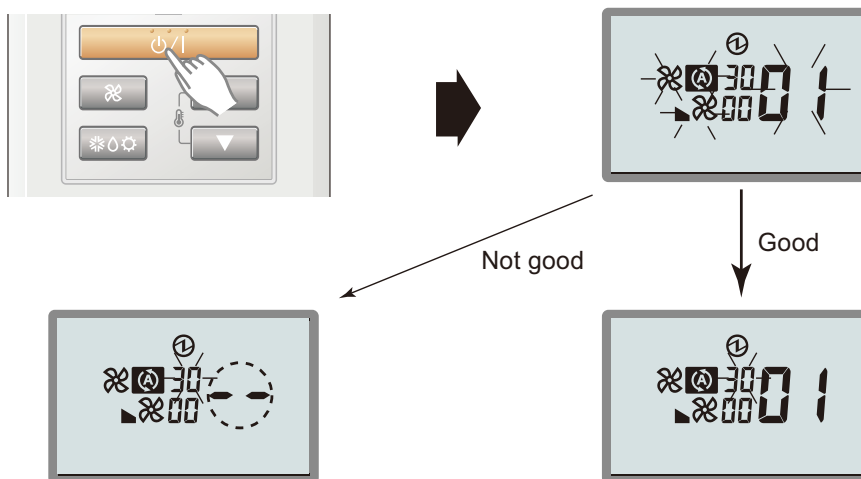

- Data is not set up on the indoor unit correctly (-- is displayed.)
- Set up the data again according to the procedure in step 3, 4 above.

Data is correctly set up on the indoor unit.

Function details: Refer to Chapter 13-5. ["Function details"](#) on page 149.

6. Exit the function setting mode by pressing the 3 buttons of SET TEMP. ▲, SET TEMP. ▼, and FAN at the same time for 5 seconds or longer. After exiting the function setting mode, the display returns to the normal mode.

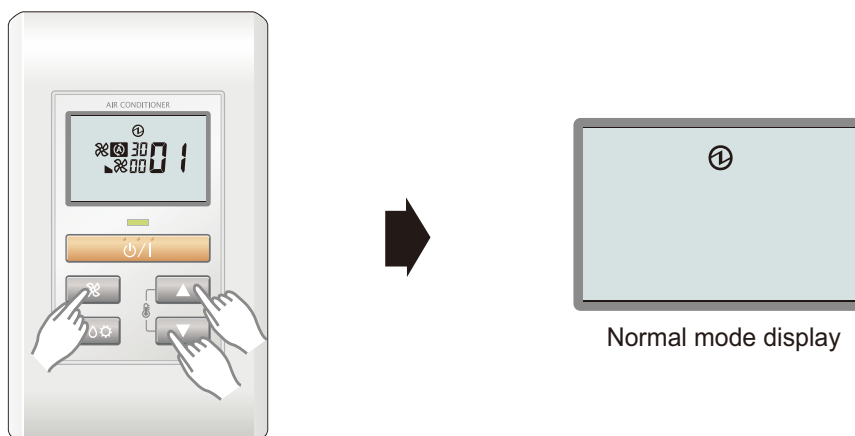

If no button is pressed within 60 seconds after buttons mentioned above are pressed, it will automatically exit the function setting mode.

If you exit the function setting mode unintentionally during setting, enter the mode again according to the procedure in step 2.

● Setting up each indoor unit

Repeat the procedures from step 1 to 6, and set up the indoor units requiring function setting.

● Resetting the power after setting up function of all indoor units

NOTES:

- If the reset is not performed, function can not be read correctly.
- After all the functions have been set, the circuit breaker needs to be switched off for at least 2 minutes.
 - After the 2 minutes has passed, power can be restored.
 - The set function is stored in the PCB and will remain in memory even when the power of indoor unit is turned off.
However setting function is effective after disconnecting the power supply and then reconnecting it.
- Record the latest configuration of the indoor unit function setting on a label, and put the label on the unit so it can be used for after-sales service operations.

13-5. Function details

■ Contents of function setting

Each function setting listed in this section is adjustable in accordance with the installation environment.

NOTE: Setting will not be changed if invalid numbers or setting values are selected.

● Function setting list

	Functions	Compact cassette	Slim duct	Wall mounted	Floor
1)	Filter sign	●	●	●	●
2)	Ceiling height	●	—	—	—
3)	Outlet directions	●	—	—	—
4)	Vertical airflow direction range control	—	—	—	●
5)	Static pressure	—	●	—	—
6)	Room temperature control for indoor unit sensor	●	●	●	●
7)	Auto restart	●	●	●	●
8)	Room temperature sensor switching	●	●	●	●
9)	Remote controller custom code	●	●	●	●
10)	External input control	●	●	●	●
11)	Room temperature sensor switching (Aux.)	●	●	●	●
12)	Indoor unit fan control for energy saving for cooling	—	—	● (ASU7/9/12/ 15RLF1)	●
13)	Room temperature control for wired remote controller sensor	●	●	●	●
14)	Heat insulation condition (building insulation)	●	●	●	●

1) Filter sign

Select appropriate intervals for displaying the filter sign on the indoor unit according to the estimated amount of dust in the air of the room.

If the indication is not required, select "No indication" (03).

Function number	Setting value	Setting description	Factory setting
11	00	Standard	
	01	Long interval	
	02	Short interval	
	03	No indication	◆

Intervals will differ depending on the indoor unit type as follows.

Setting description	Compact cassette	Slim duct	Wall mounted	Floor/Ceiling
Standard	2,500 hours		400 hours	
Long interval	4,400 hours		1,000 hours	
Short interval	1,250 hours		200 hours	

2) Ceiling height

Select the appropriate ceiling height according to the place of installation.

Function number	Setting value	Setting description	Factory setting
20	00	Standard	◆
	01	High ceiling	

For the specific height for each setting value, refer to "Installation space" in Chapter 4. "[Dimensions](#)" on page 49.

In case of cassette type models:

The ceiling height values are for the 4-way outlet. Do not change this setting in the 3-way outlet mode.

7000, 9000 Btu/h models cannot be installed in high ceilings. Do not change this setting.

3) Outlet directions

Select the appropriate number of outlet directions according to the installation conditions.

Function number	Setting value	Setting description	Factory setting
22	00	4-way	◆
	01	3-way	

4) Vertical airflow direction range control

In a concealed installation, change the setting to "Fixed" (02) to restrict the movement of the upper air outlet so that the airflow is only towards the horizontal direction.

Function number	Setting value	Setting description	Factory setting
23	00	Standard	◆
	01	(Setting prohibited)	
	02	Fixed (Concealed)	

5) Static pressure

Select the appropriate static pressure according to the installation conditions.

Function number	Setting value	Setting description	Factory setting
26	00	0 in.WG (0 Pa)	
	01	0.04 in.WG (10 Pa)	
	02	0.08 in.WG (20 Pa)	
	03	0.12 in.WG (30 Pa)	
	04	0.16 in.WG (40 Pa)	
	05	0.20 in.WG (50 Pa)	
	06	0.24 in.WG (60 Pa)	
	07	0.28 in.WG (70 Pa)	
	08	0.32 in.WG (80 Pa)	
	09	0.36 in.WG (90 Pa)	
	31	0.10 in.WG (25 Pa) (Standard)	◆

Model name	Range of static pressure
ARU7RLF	0 to 0.36 in.WG (0 to 90 Pa)
ARU9RLF	
ARU12RLF	
ARU18RLF	
ARU24RLF	0 to 0.20 in.WG (0 to 50 Pa)

6) Room temperature control for indoor unit sensor

NOTE: Before performing this setting, refer to Function 95.

Depending on the installed environment, correction of the room temperature sensor may be required. Select the appropriate control setting according to the installed environment.

The temperature correction values show the difference from the Standard setting "00" (manufacturer's recommended value).

*When Function 95-01 (High insulation) is set, the Standard setting "00" will be the same as "No correction 0.0 °F (0.0 °C)" (01).

Function number		Setting value	Setting description	Factory setting	
30 (For cooling)	31 (For heating)	00	Standard setting*	◆	
		01	No correction 0.0 °F (0.0 °C)		
		02	-1 °F (-0.5 °C)	More cooling Less heating	
		03	-2 °F (-1.0 °C)		
		04	-3 °F (-1.5 °C)		
		05	-4 °F (-2.0 °C)		
		06	-5 °F (-2.5 °C)		
		07	-6 °F (-3.0 °C)		
		08	-7 °F (-3.5 °C)		
		09	-8 °F (-4.0 °C)		
		10	+1 °F (+0.5 °C)	Less cooling More heating	
		11	+2 °F (+1.0 °C)		
		12	+3 °F (+1.5 °C)		
		13	+4 °F (+2.0 °C)		
		14	+5 °F (+2.5 °C)		
		15	+6 °F (+3.0 °C)		
		16	+7 °F (+3.5 °C)		
17	+8 °F (+4.0 °C)				

In case of Slim duct type and Floor/Ceiling type models:

In floor console installations, select "01".

7) Auto restart

Enables or disables automatic restart after a power interruption.

Function number	Setting value	Setting description	Factory setting
40	00	Enable	◆
	01	Disable	

NOTE: Auto restart is an emergency function such as for power outage etc. Do not attempt to use this function in normal operation. Be sure to operate the unit by remote controller or external device.

8) Room temperature sensor switching

(Only for wired remote controller)

When using the wired remote controller temperature sensor, change the setting to "Both" (01).

Function number	Setting value	Setting description	Factory setting
42	00	Indoor unit	◆
	01	Both	

00: Sensor on the indoor unit is active.

01: Sensors on both indoor unit and wired remote controller are active.

NOTE: Remote controller sensor must be turned on by using the remote controller.

9) Remote controller custom code

(Only for wireless remote controller)

The indoor unit custom code can be changed. Select the appropriate custom code.

Function number	Setting value	Setting description	Factory setting
44	00	A	◆
	01	B	
	02	C	
	03	D	

10) External input control

"Operation/Stop" mode or "Forced stop" mode can be selected.

Function number	Setting value	Setting description	Factory setting
46	00	Operation/Stop mode	◆
	01	(Setting prohibited)	
	02	Forced stop mode	

11) Room temperature sensor switching (Aux.)

To use the temperature sensor on the wired remote controller only, change the setting to "Wired remote controller" (01).

This function will only work if the function setting 42 is set at "Both" (01).

When the setting value is set to "Both" (00), more suitable control of the room temperature is possible by setting function setting 30 and 31 too.

Function number	Setting value	Setting description	Factory setting
48	00	Both	◆
	01	Wired remote controller	◆*

*: For Slim duct only.

12) Indoor unit fan control for energy saving for cooling

Enables or disables the power-saving function by controlling the indoor unit fan rotation when the outdoor unit is stopped during cooling operation.

Function number	Setting value	Setting description	Factory setting
49	00	Disable	◆
	01	Enable	

00: When the outdoor unit is stopped, the indoor unit fan operates continuously following the setting on the remote controller.

01: When the outdoor unit is stopped, the indoor unit fan operates intermittently at a very low speed.

13) Room temperature control for wired remote controller sensor

NOTE: Before performing this setting, refer to Function 95.

Depending on the installed environment, correction of the room temperature sensor may be required. Select the appropriate control setting according to the installed environment.

To change this setting, set Function 42 to "Both" (01).

Ensure that the thermo sensor icon is displayed on the remote controller screen.

Function number		Setting value	Setting description	Factory setting	
92 (For cooling)	93 (For heating)	00	No correction 0.0 °F (0.0 °C)	◆	
		01	No correction 0.0 °F (0.0 °C)		
		02	-1 °F (-0.5 °C)	More cooling Less heating	
		03	-2 °F (-1.0 °C)		
		04	-3 °F (-1.5 °C)		
		05	-4 °F (-2.0 °C)		
		06	-5 °F (-2.5 °C)		
		07	-6 °F (-3.0 °C)		
		08	-7 °F (-3.5 °C)		
		09	-8 °F (-4.0 °C)		
		10	+1 °F (+0.5 °C)	Less cooling More heating	
		11	+2 °F (+1.0 °C)		
		12	+3 °F (+1.5 °C)		
		13	+4 °F (+2.0 °C)		
		14	+5 °F (+2.5 °C)		
		15	+6 °F (+3.0 °C)		
		16	+7 °F (+3.5 °C)		
17	+8 °F (+4.0 °C)				

14) Heat insulation condition (building insulation)

Heat insulation conditions differ according to the installed environment.

"Standard insulation" (00) allows system to rapidly respond to the cooling or heating load changes.

"High insulation" (01) is when the heat insulation structure of the building is high and does not require system to rapidly respond to cooling or heating load changes.

When "High insulation" (01) is selected:

- Overheating (overcooling) is prevented at the start-up.
- All room-temperature control settings (Function 30, 31, 92, and 93) will reset to "No correction 0.0 °F (0.0 °C)".

Function number	Setting value	Setting description	Factory setting
95	00	Standard insulation	◆
	01	High insulation	

NOTE: When changing Function 95, perform this setting before other room-temperature control settings (Function 30, 31, 92, and 93). If Function 95 is not set first, room-temperature control settings (Function 30, 31, 92, and 93) will be reset and you must re-do them again.

13-6. Wired remote controller

DIP switch 1	SW1	Prohibited
	SW2	Dual remote controller setting
	SW3	Prohibited
	SW4	°F / °C switch
	SW5	Prohibited
	SW6	Memory backup setting

* Do not use DIP switch 2

■ Switch position

● Wired remote controller

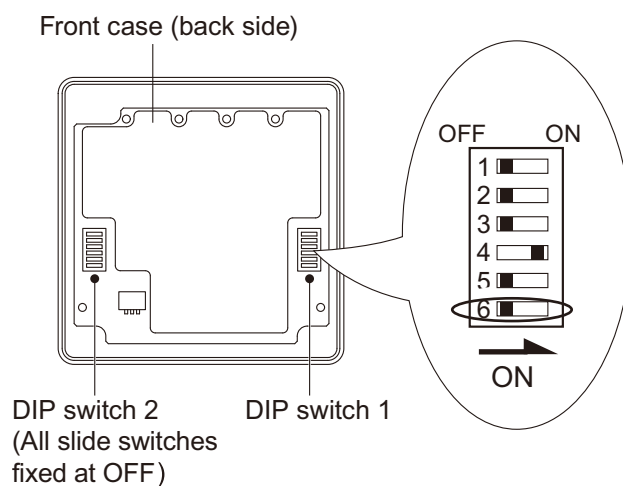

■ Dip switch 1 setting

● SW2: Dual remote controller setting

Set the remote controller SW2 according to the following table.

Number of remote controller	Primary unit	Secondary unit	Factory setting
	SW2	SW2	
1 (Normal)	OFF	—	◆
2 (Dual)	OFF	ON	

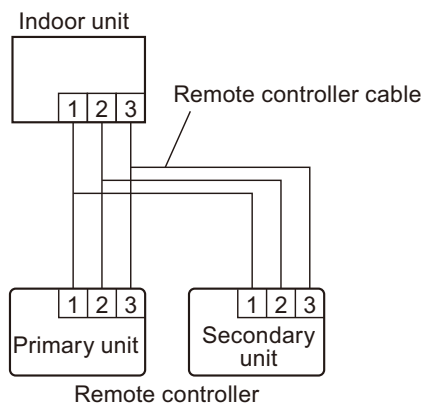

● SW4: Switching temperature unit °F / °C

Displayed temperature unit can be switched between Fahrenheit (°F) and Celsius (°C).

SW4	Fahrenheit (°F) / Celsius (°C)	Factory setting
OFF	°C	
ON	°F	◆

● SW6: Memory backup setting (only for wired remote controller)

Set to "ON" to use batteries for the memory backup.

When batteries are not used, all of settings stored in memory will be deleted if there is a power failure.

SW6	Memory backup	Factory setting
OFF	Invalidity	◆
ON	Validity	

NOTE: Never turn it on in the case of simple remote controller.

13-7. Simple remote controller

DIP switch 1	SW1	Prohibited
	SW2	Dual remote controller setting
	SW3	°F / °C switch
	SW4	Prohibited
	SW5	Prohibited
	SW6	Prohibited

Switch position

Simple remote controller

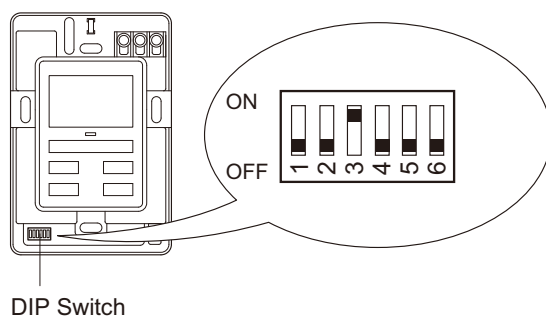

Dip switch setting

SW2: Dual remote controller setting

Set the remote controller SW2 according to the following table.

Number of remote controller	Primary unit	Secondary unit	Factory setting
	SW2	SW2	
1 (Normal)	OFF	—	◆
2 (Dual)	OFF	ON	

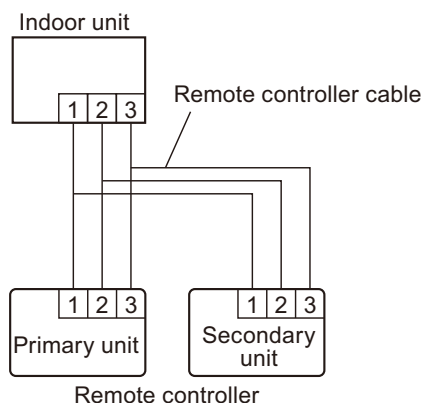

SW3: Switching temperature unit °F / °C

Displayed temperature unit can be switched between Fahrenheit (°F) and Celsius (°C).

SW3	Fahrenheit (°F) / Celsius (°C)	Factory setting
OFF	°C	
ON	°F	◆

13-8. Central remote controller

DIP switch 1	SW1	Memory backup setting
	SW2	Prohibited
	SW3	Prohibited
	SW4	Prohibited
	SW5	Prohibited
	SW6	Prohibited

■ Switch position

● Central remote controller

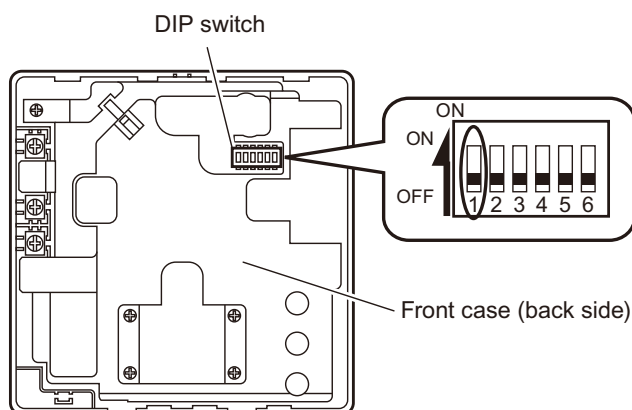

■ Dip switch setting

● SW1: Memory backup setting

Set to "ON" to use batteries for the memory backup.







When batteries are not used, all of settings stored in memory will be deleted if there is a power failure.

SW1		Factory setting
Off	Invalidity	◆
On	Validity	

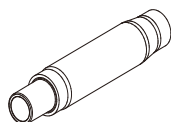

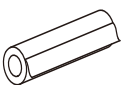
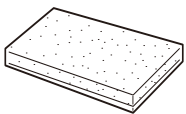
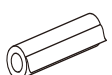
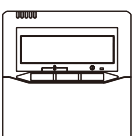

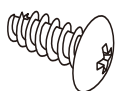
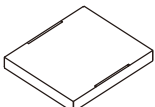

14. Accessories

14-1. Compact cassette type

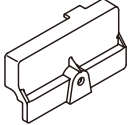
■ Models: AUU7RLF, AUU9RLF, AUU12RLF, and AUU18RLF

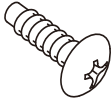
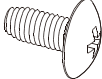

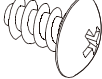





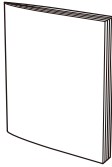

Part name	Exterior	Q'ty	Part name	Exterior	Q'ty
Operating manual		1	Drain hose		1
Installation manual		1	Hose band		1
Coupler heat insulation (Large)		1	Drain hose insulation		1
Coupler heat insulation (Small)		1	Remote controller		1
Special nut A (Large flange)		4	Remote controller cable		1
Special nut B (Small flange)		4	Tapping screw (M4 × 16 mm)		2
Template (Carton top)		1			

■ Cassette grille accessories

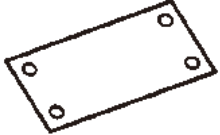
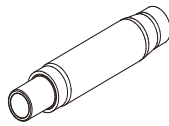
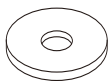
Part name	Exterior	Q'ty	Part name	Exterior	Q'ty
Connector cover		1	Hook wire		2
Tapping screw (M5 × 12 mm)		4	Screw (pitch small) (M4 × 10 mm)		2
Tapping screw (M4 × 12 mm)		1	Screw (pitch large) (M4 × 10 mm)		4
L angle		2			

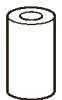

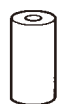
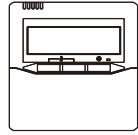
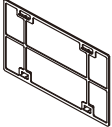

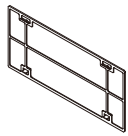
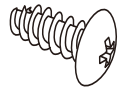

14-2. Slim duct type

■ Models: ARU7RLF, ARU9RLF, ARU12RLF, ARU18RLF, and ARU24RLF

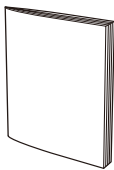
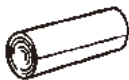
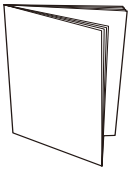
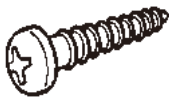
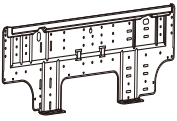

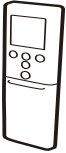
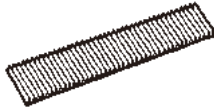

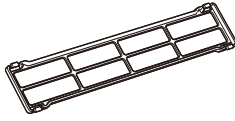

Part name	Exterior	Q'ty	Part name	Exterior	Q'ty
Operating manual		1	Cable tie (large)		4
Installation manual		1	Cable tie (small)		3
Installation template		1	Drain hose		1
Washer		8	Hose band		1
Coupler heat insulation (large)		1	Drain hose insulation B		1
Coupler heat insulation (small)		1	Remote controller		1
Filter (Small) (For AR7/9/12/24)		2	Remote controller cable		1
Filter (Big) (For AR18/24)		2 (AR 18)	Tapping screw (M4 × 16 mm)		2
		1 (AR 24)			

14-3. Wall mounted type

■ Models: ASU7RLF1, ASU9RLF1, ASU12RLF1, and ASU15RLF1

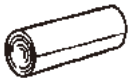
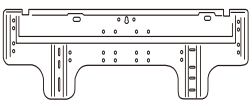



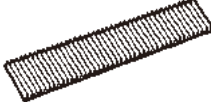
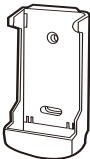
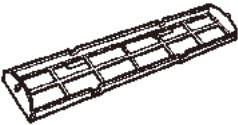

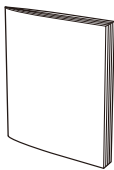

Part name	Exterior	Q'ty	Part name	Exterior	Q'ty
Operating manual		1	Cloth tape		1
Installation manual		1	Tapping screw (large), M4 × 25 mm		5
Wall hook bracket		1	Tapping screw (small),		2
Remote controller		1	Air cleaning filter		2
Battery		2	Filter holder		2
Remote controller holder		1	Seal A <ul style="list-style-type: none"> • It is necessary when using AS15. • It is used when the diameter of gas pipe is Ø12.70 or more. 		1

■ Models: ASU18RLF and ASU24RLF

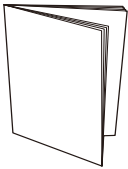
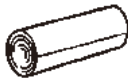
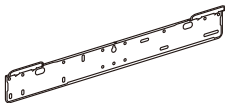
Part name	Exterior	Q'ty	Part name	Exterior	Q'ty
Operating manual		1	Drain hose insulation		1
Installation manual		1	Cloth tape		1
Wall hook bracket		1	Tapping screw (large), M4 × 25 mm		8
Remote controller		1	Tapping screw (small)		2
Battery		2	Air cleaning filter		2
Remote controller holder		1	Air cleaning filter frame		2

14-4. Floor type

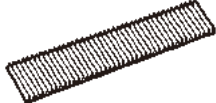
■ Models: AGU9RLF, AGU12RLF, and AGU15RLF

Part name	Exterior	Q'ty	Part name	Exterior	Q'ty
Operating manual		1	Cable tie		1
Installation manual		1	Cloth tape		1
Wall hook bracket		1	Tapping screw (large), M4 × 25 mm		9
Remote controller		1	Tapping screw (small), M3 × 12 mm		2
Battery		2	Air cleaning filter		2
Remote controller holder		1			

15. Optional parts





15-1. Controller

Lineup

Indoor unit type		Type				
		Wired remote controller	Wireless remote controller		IR receiver unit	Simple remote controller
			UTY-RNNUM	UTY-LNHUM		
Compact cassette		●	○	—	—	○
Slim duct		●	—	—	○	○
Wall mounted	ASU7RLF1 ASU9RLF1 ASU12RLF1 ASU15RLF1	○*1	—	●	—	○*1
	ASU18RLF ASU24RLF	○	●	—	—	○
Floor		○	—	●	—	○

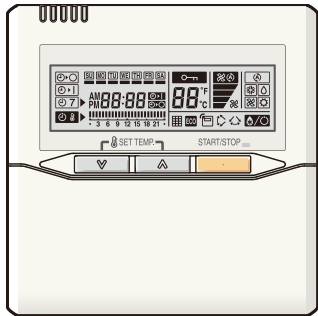
- : Accessory, ○: Optional, —: Not applicable
- *1: Optional Communication kit (UTY-XCBXZ2) is necessary for the installation.
- *2: Optional Communication kit (UTY-XCBXZ1) is necessary for the installation.
- *3: Optional Communication kit (UTY-TWBXF) is necessary for the installation.

Parts

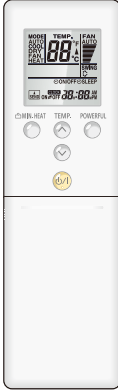
Wired remote controller	Simple remote controller	IR receiver unit
 UTY-RNNUM	 UTY-RSNUM	 UTY-LRHUM
Wireless remote controller		
 UTY-LNHUM	 AR-REG1U	

15-2. Cassette grille

■ Lineup

●: Accessory, ○: Optional, —: Not applicable

Type	Model	Indoor units
		Compact cassette
Cassette grille	UTG-CCGF	○

■ Part

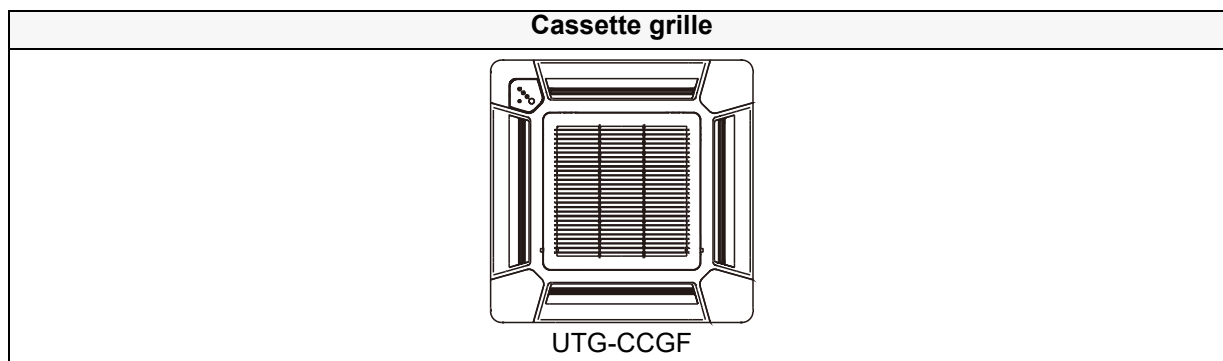

15-3. Others

■ Lineup





Indoor unit type		Type					
		Air outlet shutter plate	Insulation kit for high humidity	Fresh air intake kit	External control set	External connect kit	
		UTR-YDZB	UTZ-KXGC	UTZ-VXAA	UTD-ECS5A	UTY-XWZX	UTY-XWZXZ5
Compact cassette		○	○	○	—	○	—
Slim duct		—	—	—	○	—	—
Wall mounted	ASU7RLF1 ASU9RLF1 ASU12RLF1 ASU15RLF1	—	—	—	—	—	○*1
	ASU18RLF ASU24RLF	—	—	—	—	○	—
Floor		—	—	—	—	—	○

Indoor unit type		Type		
		Remote sensor unit	Auto louver grille kit	Communication kit
		UTY-XSZX	UTD-GXSA-W UTD-GXSB-W UTD-GXSC-W UTD-GXTA-W UTD-GXTB-W UTD-GXTC-W	UTY-XCBXZ2
Compact cassette		—	—	—
Slim duct		○	○	—
Wall mounted	ASU7RLF1 ASU9RLF1 ASU12RLF1 ASU15RLF1	—	—	○
	ASU18RLF ASU24RLF	—	—	—
Floor		—	—	—

●: Accessory, ○: Optional, —: Not applicable

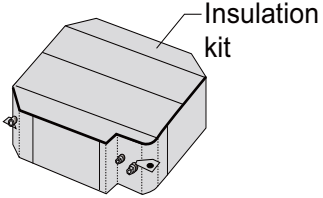
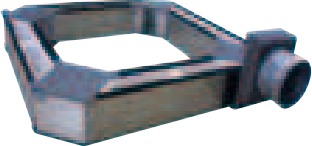
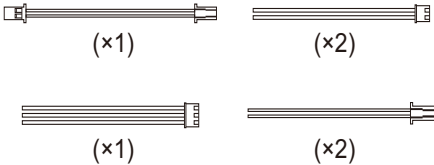
- *1: Optional Communication kit (UTY-XCBXZ2) is necessary for the installation.

Parts

<p style="text-align: center;">Air outlet shutter plate Model: UTR-YDZB</p>  <p style="text-align: center;">For compact cassette type</p>	<p style="text-align: center;">Insulation kit for high humidity Model: UTZ-KXGC</p>  <p style="text-align: center;">For compact cassette type</p>
<p style="text-align: center;">Fresh air intake kit Model: UTZ-VXAA</p>  <p style="text-align: center;">For compact cassette type</p>	<p style="text-align: center;">External control set Model: UTD-ECS5A</p>  <p style="text-align: center;">For slim duct type</p>
<p style="text-align: center;">External connect kit Model: UTY-XWZX</p>  <p style="text-align: center;">For compact cassette type and wall mounted type (ASU18RLF and ASU24RLF)</p>	<p style="text-align: center;">External connect kit Model: UTY-XWZXZ5</p>  <p style="text-align: center;">For wall mounted type (ASU7RLF1, ASU9RLF1, ASU12RLF1, and ASU15RLF1) and floor type</p>
<p style="text-align: center;">Auto louver grille kit Models: UTD-GXSA-W*1 UTD-GXSB-W*2 UTD-GXSC-W*3 UTD-GXTA-W*1 UTD-GXTB-W*2 UTD-GXTC-W*3</p>	<p style="text-align: center;">Remote sensor unit Model: UTY-XSZX</p>
 <p>*1 For slim duct (7-12 models) *2 For slim duct (18 model) *3 For slim duct (24 model)</p>	 <p style="text-align: center;">For slim duct type</p>

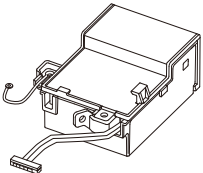
Communication kit Model: UTY-XCBXZ2	
 <p>For wall mounted type (ASU7RLF1, ASU9RLF1, ASU12RLF1, and ASU15RLF1)</p>	

16. Installation precautions

16-1. Indoor unit installation precautions

NOTE: The information listed below are general precautions. Some models also include items that do not apply.

■ Place where prohibited for use

- Places where there is a danger of combustible gas leakage.
- Places where sulfur gas, chlorine gas, acid, alkali, or other matter which effects equipment is generated.
- Places where there is a lot of oil splash and steam such as kitchen or machinery room.
- Places where machinery which generates high frequencies is used.
- Ocean beaches and other areas where there is a lot of salt.
- Places where carbon fibers or any kind of powder suspended in the air.
- Inside of vehicles, ships, and other conveyances.
- Places where voltage fluctuations are large such as a factory.

■ Points to remember when installing

- The product shall be installed at a place which can withstand the weight and vibration of the indoor.
- To allow maintenance after refrigerant piping, drain piping, and electric wiring connection and installation, provide an installation service space and an inspection port, as required.
*Installation service space is shown on “Dimensions” on page 49.
- Be careful when installing the unit at the following places.

Condition	Contents	Countermeasures (Reference)
When the ceiling is high.	If the indoor unit is installed where the installation height given in the installation manual is exceeded, the temperature difference between the floor and ceiling of the room will be large and the heating effect will be poor. Moreover, even if the indoor unit is installed within the installation height, a similar phenomena will occur when installed in a room in which the doors are opened and closed frequently and hot air circulation is obstructed by furniture such as desks or chairs.	1. Switch the setting to the high ceiling mode. 2. Install a circulator. 3. Arrange the furniture in the room so that it does not obstruct the hot air.
When lower level directly contacts the outside air.	When the lower level of the room is a semi-open space such as warehouse or parking lot the surface temperature of the flooring will become low and the radiation of cold from the floor will increase. In this case, even if the room temperature is suitable, you may feel the foot level is cold.	
When the air flow distribution is poor.	When an indoor unit is installed in a position where the outlet airflow will directly contact people, a draft may be felt. In addition, when there are obstructions in the path of the intake and outlet airflow, the air distribution may become extremely bad.	1. Adjust the louver fins or take other measures matched to the site. 2. Change the indoor unit outlet.

Condition	Contents	Countermeasures (Reference)
When inside the ceiling is high temperature and high humidity.	When the indoor unit is installed where the inside of the ceiling is 30°C (86°F) RH80% or greater, the dew point temperature of the outer perimeter may become higher than the cabinet surface temperature and moisture will condense on the surface of the cabinet and water drops may fall inside the room. →Refer to Fig. A. In addition, the humidity may vary considerably the same as when the inside of the ceiling is close to hermetically sealed and used as the outside air intake path.	1. Add heat insulating material to the outside of the indoor unit cabinet. *Regarding the cassette type, use of optional High humidity correspondence kit is recommended. 2. Strengthen the heat insulating material of the refrigerant piping and drain piping too. →Refer to Fig. B. 3. When the humidity inside the ceiling changes considerably, install a ventilation port.

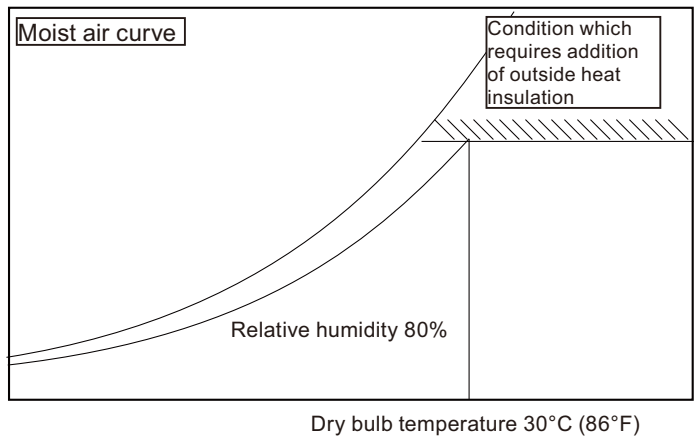

Fig. A

Work method when reinforcing the heat insulation of on-site piping

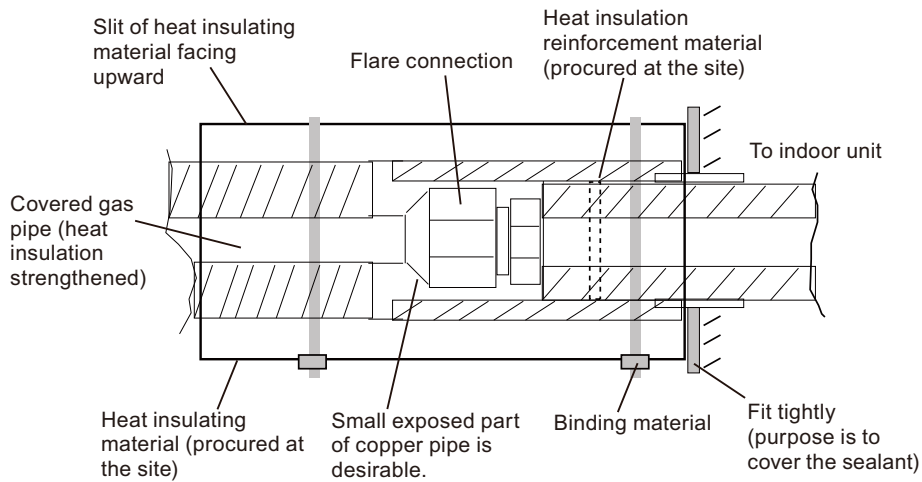

Fig. B

Condition	Contents	Countermeasures (Reference)
When using an external duct.	When using an external duct to take in new fresh air, etc., condensation may form on the surface of the duct due to the effect of the outside air temperature and the humidity inside the ceiling.	Always perform heat insulation processing. (Heat insulating material: Glass wool 25 mm (1-in) thick or more.)
When the remote controller installation site is bad.	If the cold or warm air blown out from the air conditioner directly contacts the thermostat section of the remote controller, the outlet temperature of the air conditioner may be sensed and room temperature control will be different from the room temperature, and "not cooled" or "not heated" or other trouble may occur. In addition, there is the possibility that the same kind of trouble may also occur when the remote controller is effected by direct sunlight.	1. Install the remote controller where it will not be directly exposed to the cold or hot air. 2. Install the remote controller where it will not be directly exposed to sunlight or strong lighting.
When installation environment is quiet.	When the wall mounted type was installed in a bedroom, living room, or other quiet place, the sound of the refrigerant flow may be sensed as noise and must be taken into account.	1. Plan installation of a model with external expansion valve. 2. Plan installation of a branch box farther from indoor unit. 3. Plan installation using another air conditioner.
When installing duct type in ceiling chamber system.	In the case of the ceiling chamber system (duct is not installed at indoor unit inlet side and room air is sucked into the indoor unit through the inside of the ceiling), the thermistor inside the indoor unit may not correctly detect the room temperature. <ul style="list-style-type: none"> • Heating operation: Room is not heated because the indoor unit is easily turned off by the thermostat. • Cooling operation: Room is too cold because the indoor unit is difficult to turn off by the thermostat. 	Replace the indoor unit thermistor with optional Remote sensor unit, and install the sensor where the room temperature can be correctly detected.
When the outlet air is sucked in at duct type.	Cooling operation does not cool the room and heating operation does not heat the room because the short circuited indoor unit is not turned on by the thermostat.	1. Reconsider the ventilation port construction. 2. Replace the indoor unit thermistor with optional Remote sensor unit, and install the sensor where the room temperature can be correctly detected.
When using the wireless remote controller.	Signals may not be received when using it in a room illuminated by an inverter fluorescent lamp.	Turn on the fluorescent lamp and check if the indoor unit receives the signals from the remote controller. If the indoor unit does not receive the signals, consult an authorized service personnel.
When installing the inverter type.	It may generate noise in TV sets, stereos and PCs.	The inverter type should be installed at a sufficient distance from these equipments.

Part 2. OUTDOOR UNIT

**4 ROOMS TYPE:
AOU36RLXFZH**

1. Specifications

1-1. Model: AOU36RLXFZH

OUTDOOR UNIT
AOU36RLXFZH

Type				Inverter heat pump		
Model name				AOU36RLXFZH		
Power source				1Ø 208/230 V 60 Hz		
Available voltage range				187—264V		
Connectable indoor unit		Number		2 to 4		
		Total capacity range		27,000 to 39,000 Btu/h		
Combination of indoor unit				Non-duct ASU9RLF1 x 4	Duct ARU9RLF x 4	Mix
Capacity	Cooling	Rated	Btu/h	35,200		
			kW	10.3		
		Min.—Max.	Btu/h	12,000—39,000		
	Heating	Rated	Btu/h	36,400		
			kW	10.7		
		Min.—Max.	Btu/h	12,000—42,000		
				3.5—12.3		
Input power	Cooling	Rated	kW	2.70	2.93	2.81
		Max.		3.47	3.53	3.50
	Heating	Rated		2.67	2.74	2.70
		Max.		3.29	3.35	3.32
Current	Cooling	Rated	A	11.9	12.9	12.4
	Heating	Rated	A	11.8	12.1	11.8
EER	Cooling	Rated	Btu/W	13.0	12.0	12.5
SEER *1	Cooling	Rated	-	20.0	18.0	19.0
COP	Heating	Rated	W/W	4.00	3.88	3.94
HSPF *1	Heating	Rated	-	10.3	9.3	9.8
Starting current			A	12.9		
Maximum operating current *2			A	26.0		
Fan	Type × Q'ty		Propeller × 1			
	Airflow rate	Cooling	CFM (m ³ /h)	2,472 (4,200)		
		Heating		2,472 (4,200)		
Motor	Type × Quantity		DC motor × 1			
	Output		W			
				111		
Sound pressure level	Cooling	Rated	dB (A)	53		
				55		
	Heating	Rated	dB (A)	55		
Heat exchanger	Dimension	(H x W x D)	in (mm)	38-1/16 × 36-5/16 × 2-3/16 (966 × 922 × 55)		
	Fin pitch		FPI	1.45		
	Rows × Stages		2 × 38			
	Pipe type (Material)		Grooved H-pin (Copper)			
	Fin	Type (Material)		Corrugate (Aluminum)		
Surface treatment		Corrosion resistance (Blue fin)				
Compressor	Type × Quantity		DC twin rotary × 1			
	Motor output		W			
				2,100		
Refrigerant	Type		R410A			
	Charge		lb (g)	8 lb 13 oz (4,000)		
Refrigerant oil	Type		RB68			
	Amount		in ³ (cm ³)	70.1 (1,150)		
Enclosure	Material		Painted galvanized steel			
	Color		Beige (Approximate color of MUNSELL 10YR 7.5/1.0NN)			
Dimensions	Net	(H x W x D)	in (mm)	39-5/16 × 38-3/16 × 14-9/16 (998 × 970 × 370)		
	Gross			45-3/4 × 45-1/4 × 18-13/16 (1,162 × 1,150 × 478)		
Weight	Net		lb (kg)	205 (93)		
	Gross			229 (104)		
Connection pipe	Size	Liquid	in (mm)	Ø1/4 (Ø6.35) × 4		
		Gas		Ø3/8 (Ø9.52) × 3 + Ø1/2 (Ø12.70) × 1		
	Method		Flare			
	Pre-charge length (Total)		164 (50)			
	Max. length (Total)		230 (70)			
	Max. length (Each)		82 (25)			
	Min. length (Total)		49 (15)			
	Min. length (Each)		16 (5)			
	Max. height difference between outdoor unit and each indoor units.		49 (15)			
	Max. height difference between indoor units.		33 (10)			
Operation range	Cooling	°F (°C)	14 to 115 (-10 to 46)			
	Heating		-15 to 75 (-26 to 24)			

NOTES:

- Specifications are based on the following conditions:
 - Power source of specifications : 230 V
 - Pipe length : 24.6 ft (7.5 m), Height difference : 0 ft (0 m) [Outdoor unit - Indoor unit]
 - Cooling: Indoor temperature of 80 °FDB (26.7 °CDB) / 67 °FWB (19.4 °CWB), and outdoor temperature of 95 °FDB (35 °CDB) / 75 °FWB (23.9 °CWB).
 - Heating: Indoor temperature of 70 °FDB (21.1 °CDB) / 60 °FWB (15.6 °CWB), and outdoor temperature of 47 °FDB (8.3 °CDB) / 43 °FWB (6.1 °CWB).
 - *1: Test conditions are based on AHRI 210 / 240.
 - *2: The maximum current is the maximum value when the operated within the operation range.
- For other combination, refer to the combination table.
- The protective function might work when using it outside the operation range.

2. Dimensions

2-1. Model: AOU36RLXFZH

Unit: in (mm)

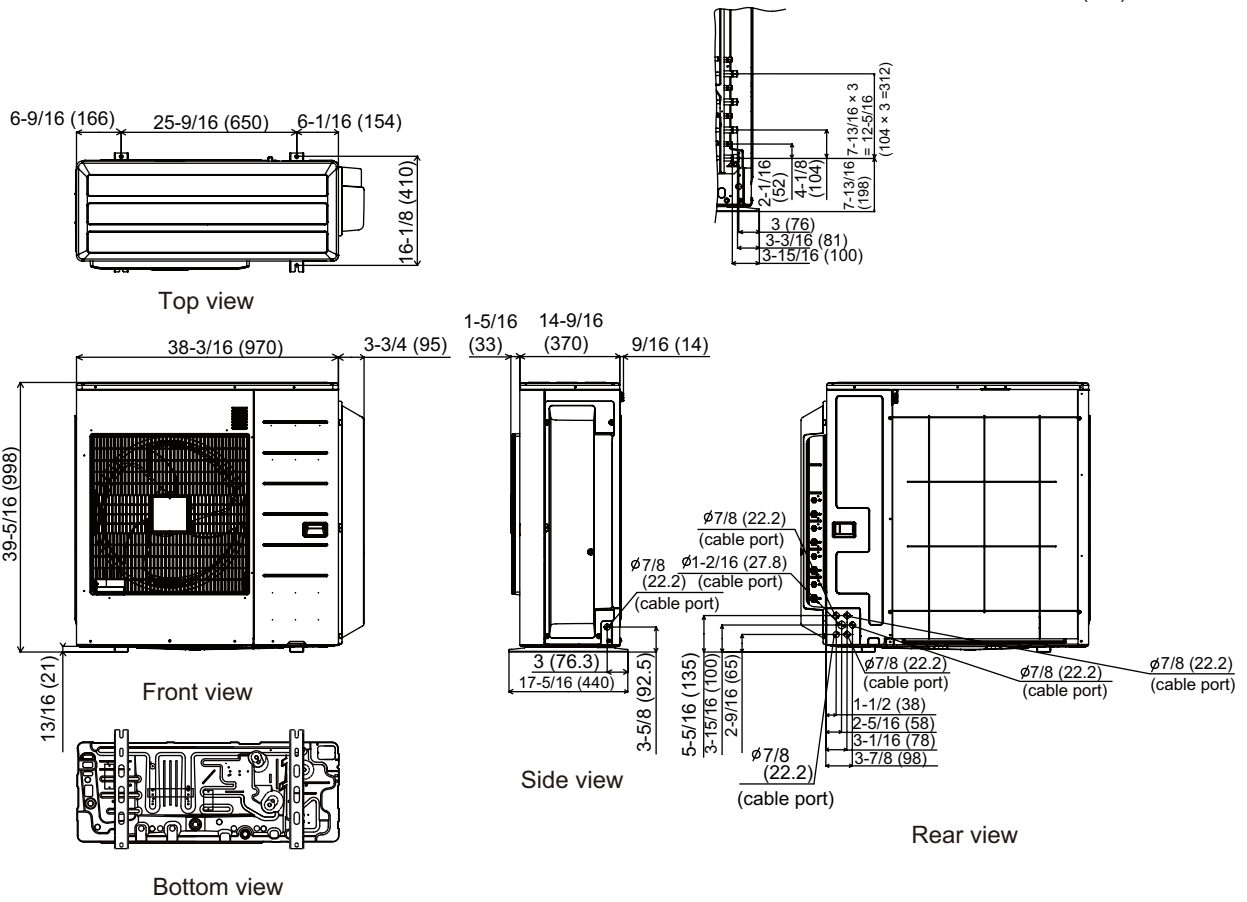

3. Installation space

OUTDOOR UNIT
AOU36RLXFZH

3-1. Model: AOU36RLXFZH

■ Space requirement

Provide sufficient installation space for product safety.

● Single outdoor unit installation

- When the upper space is open:

Unit: in (mm)

When there are obstacles at the rear only.

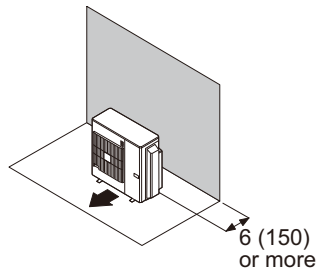

When there are obstacles at the rear and sides.

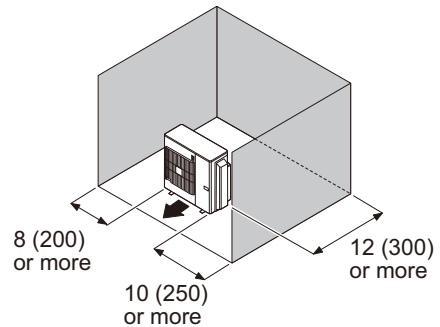

When there are obstacles at the front only.

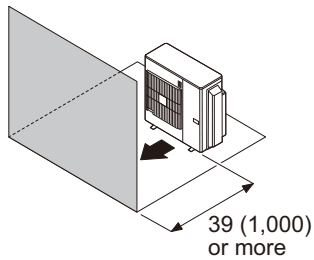

When there are obstacles at the front and rear.

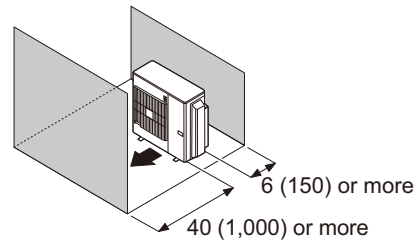

- When there is an obstruction in the upper space:

Unit: in (mm)

When there are obstacles at the rear and above.

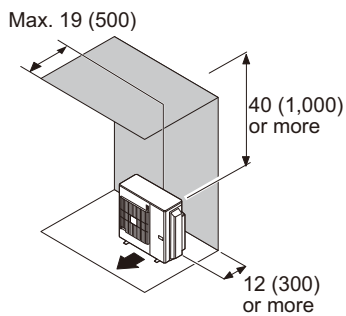

When there are obstacles at the rear, sides, and above.

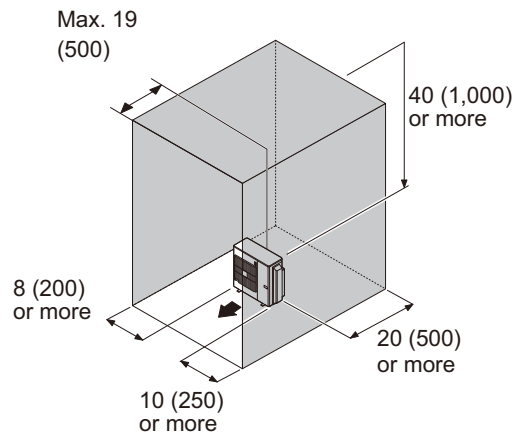

● Multiple outdoor unit installation

- When the upper space is open:

Unit: in (mm)

When there are obstacles at the rear only.

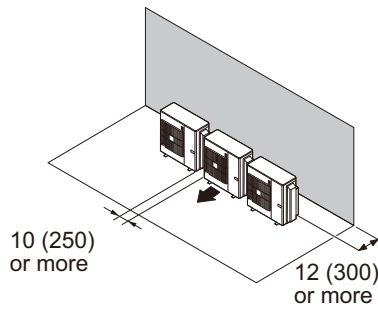

When there are obstacles at the front only.

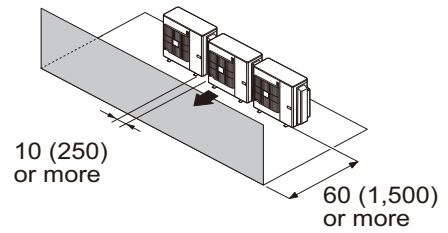

When there are obstacles at the front and rear.

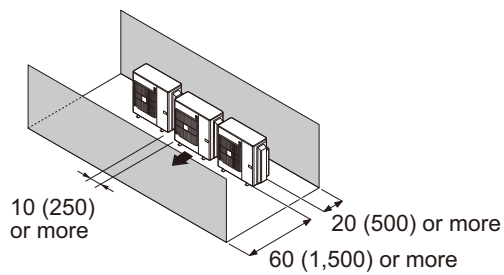

- When there is an obstruction in the upper space:

Unit: in (mm)

When there are obstacles at the rear and above.

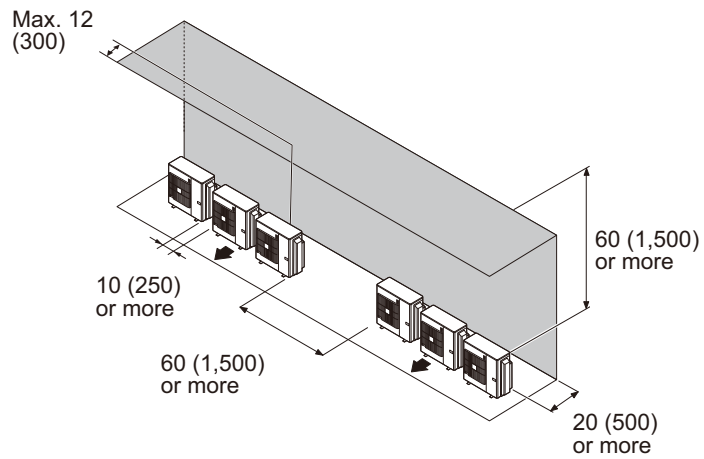

● Outdoor unit installation in multi-row

Unit: in (mm)

Single parallel unit arrangement

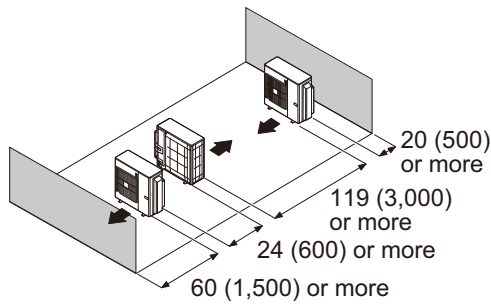

Multiple parallel unit arrangement

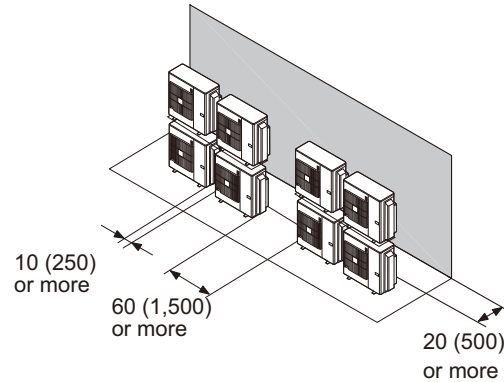
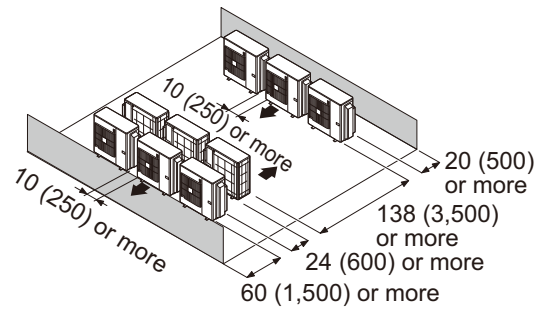

NOTES:

- If the space is larger than stated above, the condition will be the same as when there is no obstacle.
- Height above the floor level should be 2 in (50 mm) or more.
- When installing the outdoor unit, be sure to open the front and left side to obtain better operation efficiency.

⚠ CAUTION

- Do not install the outdoor unit in two-stage where the drain water could freeze. Otherwise the drainage from the upper unit may form ice and cause a malfunction of the lower unit.
- When the outdoor temperature is 32 °F (0 °C) or less, do not use the accessory drain pipe and drain cap. If the drain pipe and drain cap are used, the drain water in the pipe may freeze in extremely cold climate. (For reverse cycle model only.)
- In area with heavy snowfall, if the inlet and outlet of the outdoor unit is blocked with snow, it might become difficult to get warm, and it is likely to cause product malfunction. Construct a canopy and a pedestal, or place the unit on a high stand that is locally installed.

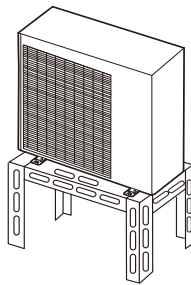

4. Refrigerant circuit

4-1. Model: AOU36RLXFZH

OUTDOOR UNIT
AOU36RLXFZH

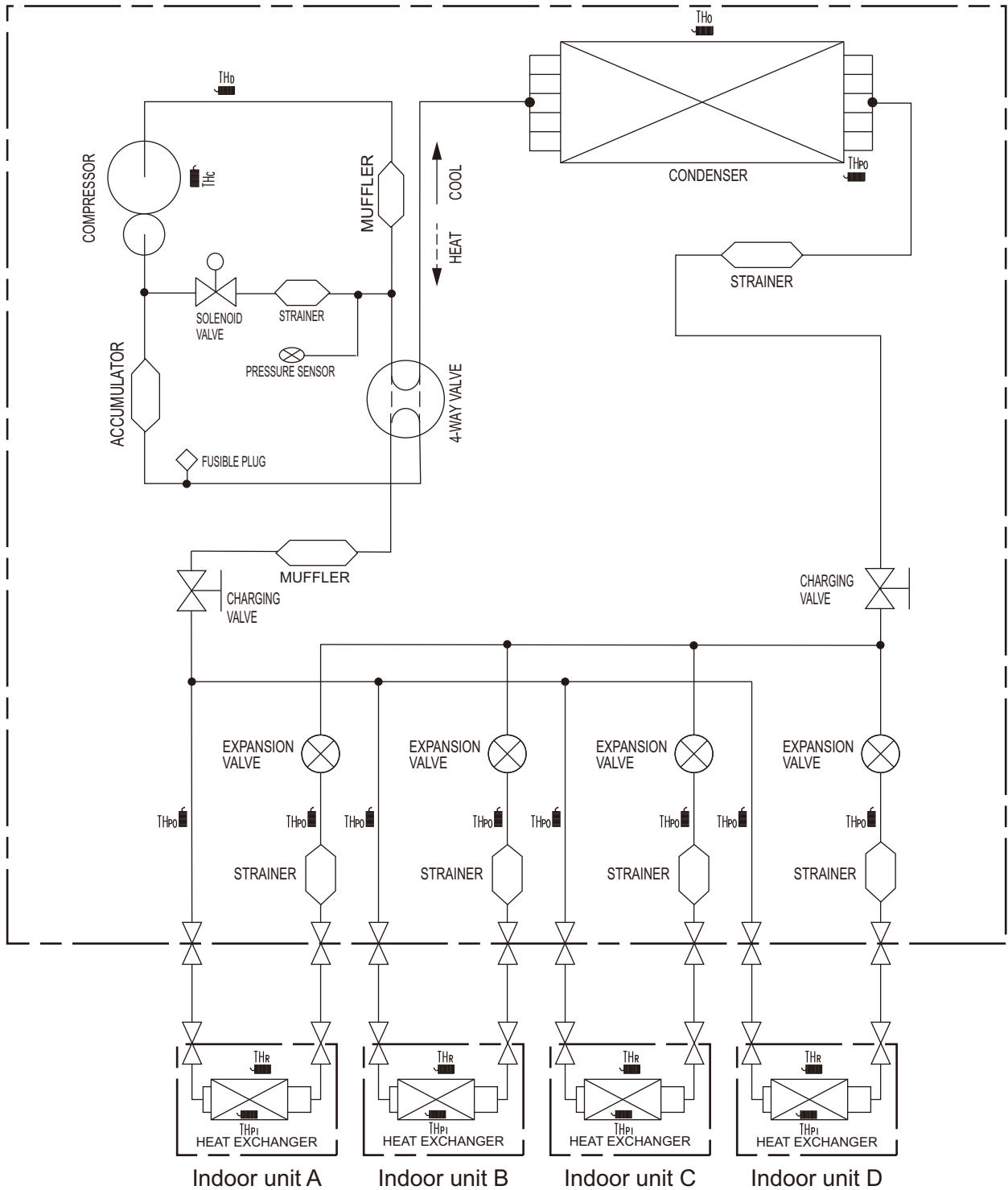

TH_D : THERMISTOR (DISCHARGE TEMP.)
 TH_o : THERMISTOR (OUTDOOR TEMP.)
 TH_{p1} : THERMISTOR (PIPE TEMP.)
 TH_c : THERMISTOR (COMPRESSOR TEMP.)

TH_r : THERMISTOR (ROOM TEMP.)
 TH_{p1} : THERMISTOR (PIPE TEMP.)

5. Wiring diagram

5-1. Model: AOU36RLXFZH

OUTDOOR UNIT
AOU36RLXFZH

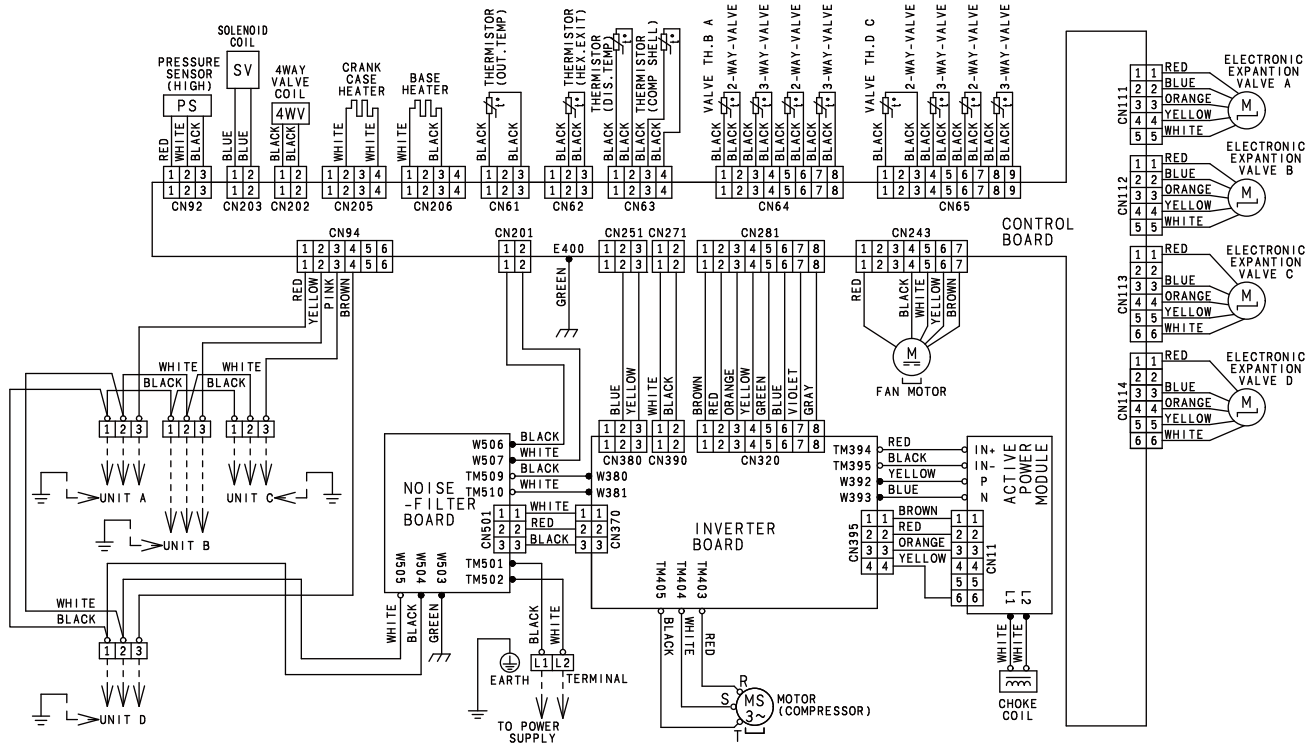

6. Capacity table

6-1. Combinations

■ Model: AOU36RLXFZH

● Cooling

Combination of indoor unit					Type of indoor unit	Rated capacity for each indoor unit (kBtu/h)				Maximum capacity for each indoor unit (kBtu/h)				Total capacity (kBtu/h)			Input power (kW)		
Room 1	Room 2	Room 3	Room 4	Total		Room 1	Room 2	Room 3	Room 4	Room 1	Room 2	Room 3	Room 4	Min.	Rated	Max.	Min.	Rated	Max.
18	18	—	—	36	Non-ducted	17.6	17.6	—	—	19.5	19.5	—	—	12.0	35.2	39.0	0.80	2.81	3.47
7	24	—	—	31	Non-ducted	6.8	23.5	—	—	7.6	26.0	—	—	12.0	30.3	33.6	0.80	2.27	2.77
9	24	—	—	33	Non-ducted	8.8	23.5	—	—	9.8	26.0	—	—	12.0	32.3	35.8	0.80	2.47	3.03
12	24	—	—	36	Non-ducted	11.7	23.5	—	—	13.0	26.0	—	—	12.0	35.2	39.0	0.80	2.81	3.47
15	24	—	—	39	Non-ducted	13.5	21.7	—	—	15.0	24.0	—	—	12.0	35.2	39.0	0.80	2.81	3.47
7	7	15	—	29	Non-ducted	6.9	6.9	14.7	—	7.6	7.6	16.2	—	12.0	28.4	31.4	0.80	2.03	2.51
7	7	18	—	32	Non-ducted	6.8	6.8	17.6	—	7.6	7.6	19.5	—	12.0	31.3	34.7	0.80	2.32	2.90
7	7	24	—	38	Non-ducted	6.5	6.5	22.2	—	7.2	7.2	24.6	—	12.0	35.2	39.0	0.80	2.76	3.47
7	9	12	—	28	Non-ducted	6.9	8.8	11.7	—	7.6	9.7	13.0	—	12.0	27.4	30.3	0.80	1.93	2.38
7	9	15	—	31	Non-ducted	6.8	8.8	14.7	—	7.6	9.8	16.3	—	12.0	30.3	33.6	0.80	2.22	2.77
7	9	18	—	34	Non-ducted	6.8	8.8	17.6	—	7.6	9.7	19.5	—	12.0	33.2	36.8	0.80	2.52	3.16
7	12	12	—	31	Non-ducted	6.8	11.7	11.7	—	7.6	13.0	13.0	—	12.0	30.3	33.6	0.80	2.22	2.77
7	12	15	—	34	Non-ducted	6.8	11.7	14.6	—	7.6	13.0	16.2	—	12.0	33.2	36.8	0.80	2.52	3.16
7	12	18	—	37	Non-ducted	6.7	11.4	17.1	—	7.4	12.6	19.0	—	12.0	35.2	39.0	0.80	2.76	3.47
9	9	9	—	27	Non-ducted	8.8	8.8	8.8	—	9.8	9.8	9.8	—	12.0	26.4	29.3	0.80	1.82	2.25
9	9	12	—	30	Non-ducted	8.8	8.8	11.7	—	9.8	9.8	13.0	—	12.0	29.3	32.5	0.80	2.12	2.64
9	9	15	—	33	Non-ducted	8.8	8.8	14.7	—	9.8	9.8	16.3	—	12.0	32.3	35.8	0.80	2.42	3.03
9	9	18	—	36	Non-ducted	8.8	8.8	17.6	—	9.8	9.8	19.5	—	12.0	35.2	39.0	0.80	2.76	3.47
9	12	12	—	33	Non-ducted	8.8	11.7	11.7	—	9.8	13.0	13.0	—	12.0	32.3	35.8	0.80	2.42	3.03
9	12	15	—	36	Non-ducted	8.8	11.7	14.7	—	9.8	13.0	16.3	—	12.0	35.2	39.0	0.80	2.76	3.47
9	12	18	—	39	Non-ducted	8.1	10.8	16.2	—	9.0	12.0	18.0	—	12.0	35.2	39.0	0.80	2.76	3.47
12	12	12	—	36	Non-ducted	11.7	11.7	11.7	—	13.0	13.0	13.0	—	12.0	35.2	39.0	0.80	2.76	3.47
12	12	15	—	39	Non-ducted	10.8	10.8	13.5	—	12.0	12.0	15.0	—	12.0	35.2	39.0	0.80	2.76	3.47
7	7	7	7	28	Non-ducted	6.9	6.9	6.9	6.9	7.6	7.6	7.6	7.6	12.0	27.4	30.3	0.80	1.89	2.38
7	7	7	9	30	Non-ducted	6.8	6.8	6.8	8.8	7.6	7.6	7.6	9.8	12.0	29.3	32.5	0.80	2.08	2.64
7	7	7	12	33	Non-ducted	6.9	6.9	6.9	11.7	7.6	7.6	7.6	13.0	12.0	32.3	35.8	0.80	2.37	3.03
7	7	7	15	36	Non-ducted	6.8	6.8	6.8	14.7	7.6	7.6	7.6	16.3	12.0	35.2	39.0	0.80	2.70	3.47
7	7	7	18	39	Non-ducted	6.3	6.3	6.3	16.2	7.0	7.0	7.0	18.0	12.0	35.2	39.0	0.80	2.70	3.47
7	7	9	9	32	Non-ducted	6.8	6.8	8.8	8.8	7.6	7.6	9.8	9.8	12.0	31.3	34.7	0.80	2.27	2.90
7	7	9	12	35	Non-ducted	6.8	6.8	8.8	11.7	7.6	7.6	9.7	13.0	12.0	34.2	37.9	0.80	2.62	3.29
7	7	9	15	38	Non-ducted	6.5	6.5	8.3	13.9	7.2	7.2	9.2	15.4	12.0	35.2	39.0	0.80	2.70	3.47
7	7	12	12	38	Non-ducted	6.5	6.5	11.1	11.1	7.2	7.2	12.3	12.3	12.0	35.2	39.0	0.80	2.70	3.47
7	9	9	9	34	Non-ducted	6.8	8.8	8.8	8.8	7.6	9.7	9.7	9.7	12.0	33.2	36.8	0.80	2.47	3.16
7	9	9	12	37	Non-ducted	6.7	8.6	8.6	11.4	7.4	9.5	9.5	12.6	12.0	35.2	39.0	0.80	2.70	3.47
9	9	9	9	36	Non-ducted	8.8	8.8	8.8	8.8	9.8	9.8	9.8	9.8	12.0	35.2	39.0	0.80	2.70	3.47
18	18	—	—	36	Ducted	17.6	17.6	—	—	19.5	19.5	—	—	12.0	35.2	39.0	0.80	3.05	3.53
7	7	18	—	32	Ducted	6.8	6.8	17.6	—	7.6	7.6	19.5	—	12.0	31.3	34.7	0.80	2.52	2.96
7	7	24	—	38	Ducted	6.5	6.5	22.2	—	7.2	7.2	24.6	—	12.0	35.2	39.0	0.80	2.99	3.53
7	9	12	—	28	Ducted	6.9	8.8	11.7	—	7.6	9.7	13.0	—	12.0	27.4	30.3	0.80	2.09	2.44
7	9	18	—	34	Ducted	6.8	8.8	17.6	—	7.6	9.7	19.5	—	12.0	33.2	36.8	0.80	2.73	3.22
7	12	12	—	31	Ducted	6.8	11.7	11.7	—	7.6	13.0	13.0	—	12.0	30.3	33.6	0.80	2.41	2.83
7	12	18	—	37	Ducted	6.7	11.4	17.1	—	7.4	12.6	19.0	—	12.0	35.2	39.0	0.80	2.99	3.53
9	9	9	—	27	Ducted	8.8	8.8	8.8	—	9.8	9.8	9.8	—	12.0	26.4	29.3	0.80	1.97	2.31
9	9	12	—	30	Ducted	8.8	8.8	11.7	—	9.8	9.8	13.0	—	12.0	29.3	32.5	0.80	2.30	2.70
9	9	18	—	36	Ducted	8.8	8.8	17.6	—	9.8	9.8	19.5	—	12.0	35.2	39.0	0.80	2.99	3.53
9	12	12	—	33	Ducted	8.8	11.7	11.7	—	9.8	13.0	13.0	—	12.0	32.3	35.8	0.80	2.62	3.09
9	12	18	—	39	Ducted	8.1	10.8	16.2	—	9.0	12.0	18.0	—	12.0	35.2	39.0	0.80	2.99	3.53
12	12	12	—	36	Ducted	11.7	11.7	11.7	—	13.0	13.0	13.0	—	12.0	35.2	39.0	0.80	2.99	3.53
7	7	7	7	28	Ducted	6.9	6.9	6.9	6.9	7.6	7.6	7.6	7.6	12.0	27.4	30.3	0.80	2.05	2.44
7	7	7	9	30	Ducted	6.8	6.8	6.8	8.8	7.6	7.6	7.6	9.8	12.0	29.3	32.5	0.80	2.25	2.70
7	7	7	12	33	Ducted	6.9	6.9	6.9	11.7	7.6	7.6	7.6	13.0	12.0	32.3	35.8	0.80	2.57	3.09
7	7	7	18	39	Ducted	6.3	6.3	6.3	16.2	7.0	7.0	7.0	18.0	12.0	35.2	39.0	0.80	2.93	3.53
7	7	9	9	32	Ducted	6.8	6.8	8.8	8.8	7.6	7.6	9.8	9.8	12.0	31.3	34.7	0.80	2.47	2.96
7	7	9	12	35	Ducted	6.8	6.8	8.8	11.7	7.6	7.6	9.7	13.0	12.0	34.2	37.9	0.80	2.85	3.35
7	7	12	12	38	Ducted	6.5	6.5	11.1	11.1	7.2	7.2	12.3	12.3	12.0	35.2	39.0	0.80	2.93	3.53
7	9	9	9	34	Ducted	6.8	8.8	8.8	8.8	7.6	9.7	9.7	9.7	12.0	33.2	36.8	0.80	2.68	3.22
7	9	9	12	37	Ducted	6.7	8.6	8.6	11.4	7.4	9.5	9.5	12.6	12.0	35.2	39.0	0.80	2.93	3.53
9	9	9	9	36	Ducted	8.8	8.8	8.8	8.8	9.8	9.8	9.8	9.8	12.0	35.2	39.0	0.80	2.93	3.53

NOTES:

- Power source of specifications: 230 V
- 7: 7,000 Btu/h, 9: 9,000 Btu/h, 12: 12,000 Btu/h, 15: 14,000 Btu/h, 18: 18,000 Btu/h, 24: 24,000 Btu/h
- 2 or more indoor units should be connected.

- Cooling: Indoor temperature of 80 °FDB (26.7 °CDB)/ 67 °FWB (19.4 °CWB), and outdoor temperature of 95 °FDB (35 °CDB) / 75 °FWB (23.9 °CWB).
- Pipe length: 24.6 ft (7.5 m), Height difference: 0 ft (0 m) [Outdoor unit - Indoor unit]
- The total ability of connected a indoor unit is up to 39,000 Btu from 27,000 Btu.
- Non-ducted system combinations input are based on ASU wall mounted models. The input of combinations including AUU cassette models may be a little higher.
- Ducted system combinations capacities are based on ARU slim duct units.

Model: AOU36RLXFZH

Heating

OUTDOOR UNIT
AOU36RLXFZH

Combination of indoor unit					Type of indoor unit	Rated capacity for each indoor unit (kBtu/h)				Maximum capacity for each indoor unit (kBtu/h)				Total capacity (kBtu/h)			Input power (kW)		
Room 1	Room 2	Room 3	Room 4	Total		Room 1	Room 2	Room 3	Room 4	Room 1	Room 2	Room 3	Room 4	Min.	Rated	Max.	Min.	Rated	Max.
18	18	—	—	36	Non-ducted	18.2	18.2	—	—	21.0	21.0	—	—	12.0	36.4	42.0	0.70	2.78	3.29
7	24	—	—	31	Non-ducted	7.1	24.2	—	—	8.2	28.0	—	—	12.0	31.3	36.2	0.70	2.35	2.78
9	24	—	—	33	Non-ducted	9.1	24.3	—	—	10.5	28.0	—	—	12.0	33.4	38.5	0.70	2.53	2.99
12	24	—	—	36	Non-ducted	12.1	24.3	—	—	14.0	28.0	—	—	12.0	36.4	42.0	0.70	2.78	3.29
15	24	—	—	39	Non-ducted	14.0	22.4	—	—	16.2	25.8	—	—	12.0	36.4	42.0	0.70	2.78	3.29
7	7	15	—	29	Non-ducted	7.1	7.1	15.2	—	8.2	8.2	17.5	—	12.0	29.3	33.8	0.70	2.14	2.58
7	7	18	—	32	Non-ducted	7.1	7.1	18.2	—	8.2	8.2	21.0	—	12.0	32.4	37.3	0.70	2.40	2.88
7	7	24	—	38	Non-ducted	6.7	6.7	23.0	—	7.7	7.7	26.5	—	12.0	36.4	42.0	0.70	2.72	3.29
7	9	12	—	28	Non-ducted	7.1	9.1	12.1	—	8.2	10.5	14.0	—	12.0	28.3	32.7	0.70	2.05	2.48
7	9	15	—	31	Non-ducted	7.1	9.1	15.1	—	8.2	10.5	17.5	—	12.0	31.3	36.2	0.70	2.30	2.78
7	9	18	—	34	Non-ducted	7.1	9.1	18.2	—	8.2	10.5	21.0	—	12.0	34.4	39.7	0.70	2.56	3.09
7	12	12	—	31	Non-ducted	7.1	12.1	12.1	—	8.2	14.0	14.0	—	12.0	31.3	36.2	0.70	2.30	2.78
7	12	15	—	34	Non-ducted	7.1	12.1	15.2	—	8.2	14.0	17.5	—	12.0	34.4	39.7	0.70	2.56	3.09
7	12	18	—	37	Non-ducted	6.9	11.8	17.7	—	7.9	13.6	20.4	—	12.0	36.4	42.0	0.70	2.72	3.29
9	9	9	—	27	Non-ducted	9.1	9.1	9.1	—	10.5	10.5	10.5	—	12.0	27.3	31.5	0.70	1.97	2.38
9	9	12	—	30	Non-ducted	9.1	9.1	12.1	—	10.5	10.5	14.0	—	12.0	30.3	35.0	0.70	2.22	2.68
9	9	15	—	33	Non-ducted	9.1	9.1	15.2	—	10.5	10.5	17.5	—	12.0	33.4	38.5	0.70	2.48	2.99
9	9	18	—	36	Non-ducted	9.1	9.1	18.2	—	10.5	10.5	21.0	—	12.0	36.4	42.0	0.70	2.72	3.29
9	12	12	—	33	Non-ducted	9.1	12.1	12.1	—	10.5	14.0	14.0	—	12.0	33.4	38.5	0.70	2.48	2.99
9	12	15	—	36	Non-ducted	9.1	12.1	15.2	—	10.5	14.0	17.5	—	12.0	36.4	42.0	0.70	2.72	3.29
9	12	18	—	39	Non-ducted	8.4	11.2	16.8	—	9.7	12.9	19.4	—	12.0	36.4	42.0	0.70	2.72	3.29
12	12	12	—	36	Non-ducted	12.1	12.1	12.1	—	14.0	14.0	14.0	—	12.0	36.4	42.0	0.70	2.72	3.29
12	12	15	—	39	Non-ducted	11.2	11.2	14.0	—	12.9	12.9	16.2	—	12.0	36.4	42.0	0.70	2.72	3.29
7	7	7	7	28	Non-ducted	7.1	7.1	7.1	7.1	8.2	8.2	8.2	8.2	12.0	28.3	32.7	0.70	2.01	2.48
7	7	7	9	30	Non-ducted	7.1	7.1	7.1	9.1	8.2	8.2	8.2	10.5	12.0	30.3	35.0	0.70	2.18	2.68
7	7	7	12	33	Non-ducted	7.1	7.1	7.1	12.1	8.2	8.2	8.2	14.0	12.0	33.4	38.5	0.70	2.43	2.99
7	7	7	15	36	Non-ducted	7.1	7.1	7.1	15.2	8.2	8.2	8.2	17.5	12.0	36.4	42.0	0.70	2.67	3.29
7	7	7	18	39	Non-ducted	6.5	6.5	6.5	16.8	7.5	7.5	7.5	19.4	12.0	36.4	42.0	0.70	2.67	3.29
7	7	9	9	32	Non-ducted	7.1	7.1	9.1	9.1	8.2	8.2	10.5	10.5	12.0	32.4	37.3	0.70	2.35	2.88
7	7	9	12	35	Non-ducted	7.1	7.1	9.1	12.1	8.2	8.2	10.5	14.0	12.0	35.4	40.8	0.70	2.72	3.19
7	7	9	15	38	Non-ducted	6.7	6.7	8.6	14.4	7.7	7.7	9.9	16.6	12.0	36.4	42.0	0.70	2.67	3.29
7	7	12	12	38	Non-ducted	6.7	6.7	11.5	11.5	7.7	7.7	13.3	13.3	12.0	36.4	42.0	0.70	2.67	3.29
7	9	9	9	34	Non-ducted	7.1	9.1	9.1	9.1	8.2	10.5	10.5	10.5	12.0	34.4	39.7	0.70	2.51	3.09
7	9	9	12	37	Non-ducted	6.9	8.9	8.9	11.8	7.9	10.2	10.2	13.6	12.0	36.4	42.0	0.70	2.67	3.29
9	9	9	9	36	Non-ducted	9.1	9.1	9.1	9.1	10.5	10.5	10.5	10.5	12.0	36.4	42.0	0.70	2.67	3.29
18	18	—	—	36	Ducted	18.2	18.2	—	—	21.0	21.0	—	—	12.0	36.4	42.0	0.70	2.85	3.35
7	7	18	—	32	Ducted	7.1	7.1	18.2	—	8.2	8.2	21.0	—	12.0	32.4	37.3	0.70	2.46	2.94
7	7	24	—	38	Ducted	6.7	6.7	23.0	—	7.7	7.7	26.5	—	12.0	36.4	42.0	0.70	2.80	3.35
7	9	12	—	28	Ducted	7.1	9.1	12.1	—	8.2	10.5	14.0	—	12.0	28.3	32.7	0.70	2.12	2.54
7	9	18	—	34	Ducted	7.1	9.1	18.2	—	8.2	10.5	21.0	—	12.0	34.4	39.7	0.70	2.63	3.14
7	12	12	—	31	Ducted	7.1	12.1	12.1	—	8.2	14.0	14.0	—	12.0	31.3	36.2	0.70	2.37	2.84
7	12	18	—	37	Ducted	6.9	11.8	17.7	—	7.9	13.6	20.4	—	12.0	36.4	42.0	0.70	2.80	3.35
9	9	9	—	27	Ducted	9.1	9.1	9.1	—	10.5	10.5	10.5	—	12.0	27.3	31.5	0.70	2.04	2.44
9	9	12	—	30	Ducted	9.1	9.1	12.1	—	10.5	10.5	14.0	—	12.0	30.3	35.0	0.70	2.29	2.74
9	9	18	—	36	Ducted	9.1	9.1	18.2	—	10.5	10.5	21.0	—	12.0	36.4	42.0	0.70	2.80	3.35
9	12	12	—	33	Ducted	9.1	12.1	12.1	—	10.5	14.0	14.0	—	12.0	33.4	38.5	0.70	2.55	3.04
9	12	18	—	39	Ducted	8.4	11.2	16.8	—	9.7	12.9	19.4	—	12.0	36.4	42.0	0.70	2.80	3.35
12	12	12	—	36	Ducted	12.1	12.1	12.1	—	14.0	14.0	14.0	—	12.0	36.4	42.0	0.70	2.80	3.35
7	7	7	7	28	Ducted	7.1	7.1	7.1	7.1	8.2	8.2	8.2	8.2	12.0	28.3	32.7	0.70	2.08	2.54
7	7	7	9	30	Ducted	7.1	7.1	7.1	9.1	8.2	8.2	8.2	10.5	12.0	30.3	35.0	0.70	2.24	2.74
7	7	7	12	33	Ducted	7.1	7.1	7.1	12.1	8.2	8.2	8.2	14.0	12.0	33.4	38.5	0.70	2.49	3.04
7	7	7	18	39	Ducted	6.5	6.5	6.5	16.8	7.5	7.5	7.5	19.4	12.0	36.4	42.0	0.70	2.74	3.35
7	7	9	9	32	Ducted	7.1	7.1	9.1	9.1	8.2	8.2	10.5	10.5	12.0	32.4	37.3	0.70	2.42	2.94
7	7	9	12	35	Ducted	7.1	7.1	9.1	12.1	8.2	8.2	10.5	14.0	12.0	35.4	40.8	0.70	2.95	3.24
7	7	12	12	38	Ducted	6.7	6.7	11.5	11.5	7.7	7.7	13.3	13.3	12.0	36.4	42.0	0.70	2.74	3.35
7	9	9	9	34	Ducted	7.1	9.1	9.1	9.1	8.2	10.5	10.5	10.5	12.0	34.4	39.7	0.70	2.57	3.14
7	9	9	12	37	Ducted	6.9	8.9	8.9	11.8	7.9	10.2	10.2	13.6	12.0	36.4	42.0	0.70	2.74	3.35
9	9	9	9	36	Ducted	9.1	9.1	9.1	9.1	10.5	10.5	10.5	10.5	12.0	36.4	42.0	0.70	2.74	3.35

NOTES:

- Power source of specifications: 230 V
- 7: 7,000 Btu/h, 9: 9,000 Btu/h, 12: 12,000 Btu/h, 15: 14,000 Btu/h, 18: 18,000 Btu/h, 24: 24,000 Btu/h
- 2 or more indoor units should be connected.
- Heating: Indoor temperature of 70 °FDB (21.1 °CDB)/ 60 °FWB (15.6 °CWB), and outdoor temperature of 47 °FDB (8.3 °CDB) / 43 °FWB (6.1 °CWB).
- Pipe length: 24.6 ft (7.5 m), Height difference: 0 ft (0 m) [Outdoor unit - Indoor unit]
- The total ability of connected a indoor unit is up to 39,000 Btu from 27,000 Btu.
- Non-ducted system combinations input are based on ASU wall mounted models. The input of combinations including AUU cassette models may be a little higher.

- Ducted system combinations capacities are based on ARU slim duct units.

6-2. Cooling capacity

Model: AOU36RLXFZH

NOTE: Values mentioned in the table are calculated based on the maximum capacity.

Cooling capacity in kBtu/h

TC: Total Capacity (kBtu/h), IP: Input Power (kW)

Indoor unit connecting capacity	Outdoor temperature	Indoor temperature											
		64 °FDB		70 °FDB		75 °FDB		80 °FDB		85 °FDB		90 °FDB	
		54 °FWB		60 °FWB		63 °FWB		67 °FWB		71 °FWB		73 °FWB	
kBtu/h	°FDB	TC	IP	TC	IP	TC	IP	TC	IP	TC	IP	TC	IP
39	14	30.6	1.13	34.6	1.15	36.4	1.16	39.0	1.17	41.7	1.18	43.0	1.19
	23	30.6	1.18	34.6	1.20	36.4	1.21	39.0	1.22	41.7	1.24	43.0	1.24
	32	30.6	1.23	34.6	1.25	36.4	1.26	39.0	1.28	41.7	1.29	43.0	1.30
	41	30.6	1.37	34.6	1.39	36.4	1.41	39.0	1.42	41.7	1.44	43.0	1.45
	50	30.6	1.51	34.6	1.54	36.4	1.55	39.0	1.57	41.7	1.59	43.0	1.59
	59	30.6	2.08	34.6	2.12	36.4	2.13	39.0	2.16	41.7	2.18	43.0	2.19
	67	30.6	2.65	34.6	2.69	36.4	2.72	39.0	2.75	41.7	2.78	43.0	2.79
	77	30.6	2.92	34.6	2.97	36.4	2.99	39.0	3.03	41.7	3.06	43.0	3.08
	87	30.6	3.19	34.6	3.24	36.4	3.27	39.0	3.31	41.7	3.34	43.0	3.36
	95	30.6	3.40	34.6	3.46	36.4	3.49	39.0	3.53	41.7	3.57	43.0	3.59
	104	28.9	3.71	32.7	3.78	34.5	3.81	36.9	3.85	39.4	3.89	40.7	3.92
115	27.3	4.02	30.8	4.09	32.5	4.12	34.8	4.17	37.2	4.22	38.4	4.24	
38	14	30.6	1.13	34.6	1.15	36.4	1.16	39.0	1.17	41.7	1.18	43.0	1.19
	23	30.6	1.18	34.6	1.20	36.4	1.21	39.0	1.22	41.7	1.24	43.0	1.24
	32	30.6	1.23	34.6	1.25	36.4	1.26	39.0	1.28	41.7	1.29	43.0	1.30
	41	30.6	1.37	34.6	1.39	36.4	1.41	39.0	1.42	41.7	1.44	43.0	1.45
	50	30.6	1.51	34.6	1.54	36.4	1.55	39.0	1.57	41.7	1.59	43.0	1.59
	59	30.6	2.08	34.6	2.12	36.4	2.13	39.0	2.16	41.7	2.18	43.0	2.19
	67	30.6	2.65	34.6	2.69	36.4	2.72	39.0	2.75	41.7	2.78	43.0	2.79
	77	30.6	2.92	34.6	2.97	36.4	2.99	39.0	3.03	41.7	3.06	43.0	3.08
	87	30.6	3.19	34.6	3.24	36.4	3.27	39.0	3.31	41.7	3.34	43.0	3.36
	95	30.6	3.40	34.6	3.46	36.4	3.49	39.0	3.53	41.7	3.57	43.0	3.59
	104	28.9	3.71	32.7	3.78	34.5	3.81	36.9	3.85	39.4	3.89	40.7	3.92
115	27.3	4.02	30.8	4.09	32.5	4.12	34.8	4.17	37.2	4.22	38.4	4.24	
37	14	30.6	1.13	34.6	1.15	36.4	1.16	39.0	1.17	41.7	1.18	43.0	1.19
	23	30.6	1.18	34.6	1.20	36.4	1.21	39.0	1.22	41.7	1.24	43.0	1.24
	32	30.6	1.23	34.6	1.25	36.4	1.26	39.0	1.28	41.7	1.29	43.0	1.30
	41	30.6	1.37	34.6	1.39	36.4	1.41	39.0	1.42	41.7	1.44	43.0	1.45
	50	30.6	1.51	34.6	1.54	36.4	1.55	39.0	1.57	41.7	1.59	43.0	1.59
	59	30.6	2.08	34.6	2.12	36.4	2.13	39.0	2.16	41.7	2.18	43.0	2.19
	67	30.6	2.65	34.6	2.69	36.4	2.72	39.0	2.75	41.7	2.78	43.0	2.79
	77	30.6	2.92	34.6	2.97	36.4	2.99	39.0	3.03	41.7	3.06	43.0	3.08
	87	30.6	3.19	34.6	3.24	36.4	3.27	39.0	3.31	41.7	3.34	43.0	3.36
	95	30.6	3.40	34.6	3.46	36.4	3.49	39.0	3.53	41.7	3.57	43.0	3.59
	104	28.9	3.71	32.7	3.78	34.5	3.81	36.9	3.85	39.4	3.89	40.7	3.92
115	27.3	4.02	30.8	4.09	32.5	4.12	34.8	4.17	37.2	4.22	38.4	4.24	
36	14	30.6	1.13	34.6	1.15	36.4	1.16	39.0	1.17	41.7	1.18	43.0	1.19
	23	30.6	1.18	34.6	1.20	36.4	1.21	39.0	1.22	41.7	1.24	43.0	1.24
	32	30.6	1.23	34.6	1.25	36.4	1.26	39.0	1.28	41.7	1.29	43.0	1.30
	41	30.6	1.37	34.6	1.39	36.4	1.41	39.0	1.42	41.7	1.44	43.0	1.45
	50	30.6	1.51	34.6	1.54	36.4	1.55	39.0	1.57	41.7	1.59	43.0	1.59
	59	30.6	2.08	34.6	2.12	36.4	2.13	39.0	2.16	41.7	2.18	43.0	2.19
	67	30.6	2.65	34.6	2.69	36.4	2.72	39.0	2.75	41.7	2.78	43.0	2.79
	77	30.6	2.92	34.6	2.97	36.4	2.99	39.0	3.03	41.7	3.06	43.0	3.08
	87	30.6	3.19	34.6	3.24	36.4	3.27	39.0	3.31	41.7	3.34	43.0	3.36
	95	30.6	3.40	34.6	3.46	36.4	3.49	39.0	3.53	41.7	3.57	43.0	3.59
	104	28.9	3.71	32.7	3.78	34.5	3.81	36.9	3.85	39.4	3.89	40.7	3.92
115	27.3	4.02	30.8	4.09	32.5	4.12	34.8	4.17	37.2	4.22	38.4	4.24	
35	14	29.7	1.07	33.6	1.09	35.4	1.10	37.9	1.11	40.5	1.12	41.8	1.13
	23	29.7	1.12	33.6	1.14	35.4	1.15	37.9	1.16	40.5	1.17	41.8	1.18
	32	29.7	1.17	33.6	1.19	35.4	1.20	37.9	1.21	40.5	1.22	41.8	1.23
	41	29.7	1.30	33.6	1.32	35.4	1.33	37.9	1.35	40.5	1.36	41.8	1.37
	50	29.7	1.43	33.6	1.46	35.4	1.47	37.9	1.49	40.5	1.50	41.8	1.51
	59	29.7	1.97	33.6	2.01	35.4	2.02	37.9	2.05	40.5	2.07	41.8	2.08
	67	29.7	2.51	33.6	2.56	35.4	2.58	37.9	2.61	40.5	2.63	41.8	2.65
	77	29.7	2.77	33.6	2.82	35.4	2.84	37.9	2.87	40.5	2.90	41.8	2.92
	87	29.7	3.02	33.6	3.08	35.4	3.10	37.9	3.14	40.5	3.17	41.8	3.19
	95	29.7	3.23	33.6	3.28	35.4	3.31	37.9	3.35	40.5	3.39	41.8	3.40
	104	28.1	3.52	31.8	3.58	33.5	3.61	35.9	3.65	38.4	3.69	39.5	3.71
115	28.1	3.81	31.8	3.88	33.5	3.91	35.9	3.96	38.4	4.00	39.5	4.02	

OUTDOOR UNIT
AOU36RLXFZH

Indoor unit connecting capacity	Outdoor temperature	Indoor temperature											
		64 °FDB		70 °FDB		75 °FDB		80 °FDB		85 °FDB		90 °FDB	
		54 °FWB		60 °FWB		63 °FWB		67 °FWB		71 °FWB		73 °FWB	
kBtu/h	°FDB	TC	IP	TC	IP	TC	IP	TC	IP	TC	IP	TC	IP
34	14	28.9	1.03	32.6	1.05	34.4	1.05	36.8	1.07	39.4	1.08	40.6	1.08
	23	28.9	1.07	32.6	1.09	34.4	1.10	36.8	1.11	39.4	1.13	40.6	1.13
	32	28.9	1.12	32.6	1.14	34.4	1.15	36.8	1.16	39.4	1.18	40.6	1.18
	41	28.9	1.25	32.6	1.27	34.4	1.28	36.8	1.30	39.4	1.31	40.6	1.32
	50	28.9	1.38	32.6	1.40	34.4	1.41	36.8	1.43	39.4	1.45	40.6	1.45
	59	28.9	1.90	32.6	1.93	34.4	1.94	36.8	1.97	39.4	1.99	40.6	2.00
	67	28.9	2.41	32.6	2.46	34.4	2.48	36.8	2.50	39.4	2.53	40.6	2.55
	77	28.9	2.66	32.6	2.71	34.4	2.73	36.8	2.76	39.4	2.79	40.6	2.81
	87	28.9	2.91	32.6	2.96	34.4	2.98	36.8	3.01	39.4	3.05	40.6	3.07
	95	28.9	3.10	32.6	3.16	34.4	3.18	36.8	3.22	39.4	3.26	40.6	3.27
	104	27.3	3.38	30.9	3.44	32.6	3.47	34.9	3.51	37.3	3.55	38.4	3.57
115	27.3	3.67	30.9	3.73	32.6	3.76	34.9	3.80	37.3	3.85	38.4	3.87	
33	14	28.0	0.99	31.7	1.00	33.4	1.01	35.8	1.02	38.2	1.03	39.4	1.04
	23	28.0	1.03	31.7	1.05	33.4	1.06	35.8	1.07	38.2	1.08	39.4	1.09
	32	28.0	1.08	31.7	1.09	33.4	1.10	35.8	1.12	38.2	1.13	39.4	1.14
	41	28.0	1.20	31.7	1.22	33.4	1.23	35.8	1.24	38.2	1.26	39.4	1.26
	50	28.0	1.32	31.7	1.35	33.4	1.36	35.8	1.37	38.2	1.39	39.4	1.39
	59	28.0	1.82	31.7	1.85	33.4	1.87	35.8	1.89	38.2	1.91	39.4	1.92
	67	28.0	2.32	31.7	2.36	33.4	2.38	35.8	2.40	38.2	2.43	39.4	2.44
	77	28.0	2.55	31.7	2.60	33.4	2.62	35.8	2.65	38.2	2.68	39.4	2.69
	87	28.0	2.79	31.7	2.84	33.4	2.86	35.8	2.89	38.2	2.93	39.4	2.94
	95	28.0	2.98	31.7	3.03	33.4	3.05	35.8	3.09	38.2	3.12	39.4	3.14
	104	26.5	3.25	30.0	3.30	31.6	3.33	33.8	3.37	36.2	3.41	37.3	3.43
115	26.5	3.52	30.0	3.58	31.6	3.61	33.8	3.65	36.2	3.69	37.3	3.71	
32	14	27.2	0.94	30.7	0.96	32.4	0.97	34.7	0.98	37.1	0.99	38.2	1.00
	23	27.2	0.99	30.7	1.01	32.4	1.01	34.7	1.02	37.1	1.04	38.2	1.04
	32	27.2	1.03	30.7	1.05	32.4	1.06	34.7	1.07	37.1	1.08	38.2	1.09
	41	27.2	1.15	30.7	1.17	32.4	1.18	34.7	1.19	37.1	1.21	38.2	1.21
	50	27.2	1.27	30.7	1.29	32.4	1.30	34.7	1.31	37.1	1.33	38.2	1.34
	59	27.2	1.74	30.7	1.77	32.4	1.79	34.7	1.81	37.1	1.83	38.2	1.84
	67	27.2	2.22	30.7	2.26	32.4	2.28	34.7	2.30	37.1	2.33	38.2	2.34
	77	27.2	2.45	30.7	2.49	32.4	2.51	34.7	2.54	37.1	2.57	38.2	2.58
	87	27.2	2.67	30.7	2.72	32.4	2.74	34.7	2.77	37.1	2.80	38.2	2.82
	95	27.2	2.85	30.7	2.90	32.4	2.93	34.7	2.96	37.1	2.99	38.2	3.01
	104	25.7	3.11	29.1	3.17	30.6	3.19	32.8	3.23	35.1	3.26	36.1	3.28
115	25.7	3.37	29.1	3.43	30.6	3.46	32.8	3.50	35.1	3.54	36.1	3.56	
31	14	26.3	0.90	29.8	0.92	31.4	0.93	33.6	0.94	35.9	0.95	37.0	0.95
	23	26.3	0.94	29.8	0.96	31.4	0.97	33.6	0.98	35.9	0.99	37.0	1.00
	32	26.3	0.99	29.8	1.00	31.4	1.01	33.6	1.02	35.9	1.03	37.0	1.04
	41	26.3	1.10	29.8	1.12	31.4	1.13	33.6	1.14	35.9	1.15	37.0	1.16
	50	26.3	1.21	29.8	1.23	31.4	1.24	33.6	1.26	35.9	1.27	37.0	1.28
	59	26.3	1.67	29.8	1.70	31.4	1.71	33.6	1.73	35.9	1.75	37.0	1.76
	67	26.3	2.12	29.8	2.16	31.4	2.18	33.6	2.20	35.9	2.23	37.0	2.24
	77	26.3	2.34	29.8	2.38	31.4	2.40	33.6	2.43	35.9	2.45	37.0	2.47
	87	26.3	2.55	29.8	2.60	31.4	2.62	33.6	2.65	35.9	2.68	37.0	2.69
	95	26.3	2.73	29.8	2.78	31.4	2.80	33.6	2.83	35.9	2.86	37.0	2.88
	104	24.9	2.97	28.2	3.03	29.7	3.05	31.8	3.09	34.0	3.12	35.0	3.14
115	24.9	3.22	28.2	3.28	29.7	3.31	31.8	3.34	34.0	3.38	35.0	3.40	
30	14	25.5	0.86	28.8	0.88	30.4	0.88	32.5	0.89	34.7	0.90	35.8	0.91
	23	25.5	0.90	28.8	0.92	30.4	0.92	32.5	0.93	34.7	0.95	35.8	0.95
	32	25.5	0.94	28.8	0.96	30.4	0.96	32.5	0.98	34.7	0.99	35.8	0.99
	41	25.5	1.05	28.8	1.07	30.4	1.08	32.5	1.09	34.7	1.10	35.8	1.11
	50	25.5	1.16	28.8	1.18	30.4	1.19	32.5	1.20	34.7	1.21	35.8	1.22
	59	25.5	1.59	28.8	1.62	30.4	1.63	32.5	1.65	34.7	1.67	35.8	1.68
	67	25.5	2.03	28.8	2.06	30.4	2.08	32.5	2.10	34.7	2.12	35.8	2.14
	77	25.5	2.23	28.8	2.27	30.4	2.29	32.5	2.31	34.7	2.34	35.8	2.35
	87	25.5	2.44	28.8	2.48	30.4	2.50	32.5	2.53	34.7	2.56	35.8	2.57
	95	25.5	2.60	28.8	2.65	30.4	2.67	32.5	2.70	34.7	2.73	35.8	2.75
	104	24.1	2.84	27.2	2.89	28.7	2.91	30.8	2.94	32.9	2.98	33.9	2.99
115	24.1	3.07	27.2	3.13	28.7	3.15	30.8	3.19	32.9	3.23	33.9	3.24	
29	14	24.6	0.82	27.8	0.83	29.3	0.84	31.4	0.85	33.6	0.86	34.6	0.87
	23	24.6	0.86	27.8	0.87	29.3	0.88	31.4	0.89	33.6	0.90	34.6	0.91
	32	24.6	0.90	27.8	0.91	29.3	0.92	31.4	0.93	33.6	0.94	34.6	0.94
	41	24.6	1.00	27.8	1.02	29.3	1.02	31.4	1.04	33.6	1.05	34.6	1.05
	50	24.6	1.10	27.8	1.12	29.3	1.13	31.4	1.14	33.6	1.15	34.6	1.16
	59	24.6	1.51	27.8	1.54	29.3	1.55	31.4	1.57	33.6	1.59	34.6	1.60
	67	24.6	1.93	27.8	1.96	29.3	1.98	31.4	2.00	33.6	2.02	34.6	2.03
	77	24.6	2.12	27.8	2.16	29.3	2.18	31.4	2.20	33.6	2.23	34.6	2.24
	87	24.6	2.32	27.8	2.36	29.3	2.38	31.4	2.41	33.6	2.43	34.6	2.45
	95	24.6	2.48	27.8	2.52	29.3	2.54	31.4	2.57	33.6	2.60	34.6	2.61
	104	23.3	2.70	26.3	2.75	27.8	2.77	29.7	2.80	31.8	2.84	32.8	2.85
115	23.3	2.93	26.3	2.98	27.8	3.00	29.7	3.04	31.8	3.07	32.8	3.09	

Indoor unit connecting capacity	Outdoor temperature	Indoor temperature											
		64 °FDB		70 °FDB		75 °FDB		80 °FDB		85 °FDB		90 °FDB	
		54 °FWB		60 °FWB		63 °FWB		67 °FWB		71 °FWB		73 °FWB	
kBtu/h	°FDB	TC	IP	TC	IP	TC	IP	TC	IP	TC	IP	TC	IP
28	14	23.8	0.78	26.9	0.79	28.3	0.80	30.3	0.81	32.4	0.82	33.4	0.82
	23	23.8	0.81	26.9	0.83	28.3	0.84	30.3	0.85	32.4	0.85	33.4	0.86
	32	23.8	0.85	26.9	0.87	28.3	0.87	30.3	0.88	32.4	0.89	33.4	0.90
	41	23.8	0.95	26.9	0.96	28.3	0.97	30.3	0.98	32.4	0.99	33.4	1.00
	50	23.8	1.04	26.9	1.06	28.3	1.07	30.3	1.08	32.4	1.10	33.4	1.10
	59	23.8	1.44	26.9	1.46	28.3	1.47	30.3	1.49	32.4	1.51	33.4	1.52
	67	23.8	1.83	26.9	1.86	28.3	1.88	30.3	1.90	32.4	1.92	33.4	1.93
	77	23.8	2.02	26.9	2.05	28.3	2.07	30.3	2.09	32.4	2.12	33.4	2.13
	87	23.8	2.20	26.9	2.24	28.3	2.26	30.3	2.29	32.4	2.31	33.4	2.32
	95	23.8	2.35	26.9	2.39	28.3	2.41	30.3	2.44	32.4	2.47	33.4	2.48
	104	22.5	2.57	25.4	2.61	26.8	2.63	28.7	2.66	30.7	2.69	31.6	2.71
27	14	22.5	2.78	25.4	2.83	26.8	2.85	28.7	2.88	30.7	2.92	31.6	2.93
	23	22.9	0.74	25.9	0.75	27.3	0.76	29.3	0.77	31.3	0.77	32.2	0.78
	32	22.9	0.77	25.9	0.79	27.3	0.79	29.3	0.80	31.3	0.81	32.2	0.81
	41	22.9	0.81	25.9	0.82	27.3	0.83	29.3	0.84	31.3	0.84	32.2	0.85
	50	22.9	0.90	25.9	0.91	27.3	0.92	29.3	0.93	31.3	0.94	32.2	0.95
	59	22.9	0.99	25.9	1.01	27.3	1.01	29.3	1.03	31.3	1.04	32.2	1.04
	67	22.9	1.36	25.9	1.39	27.3	1.40	29.3	1.41	31.3	1.43	32.2	1.44
	77	22.9	1.73	25.9	1.76	27.3	1.78	29.3	1.80	31.3	1.82	32.2	1.83
	87	22.9	1.91	25.9	1.94	27.3	1.96	29.3	1.98	31.3	2.00	32.2	2.02
	95	22.9	2.09	25.9	2.12	27.3	2.14	29.3	2.16	31.3	2.19	32.2	2.20
	104	22.9	2.23	25.9	2.27	27.3	2.29	29.3	2.31	31.3	2.34	32.2	2.35
115	21.7	2.43	24.5	2.47	25.8	2.49	27.7	2.52	29.6	2.55	30.5	2.56	
	21.7	2.63	24.5	2.68	25.8	2.70	27.7	2.73	29.6	2.76	30.5	2.78	

NOTE:

Specifications are based on the following conditions.

- Power source of specifications: 230 V
- 2 or more indoor units should be connected.
- Pipe length: 24.6 ft (7.5 m), Height difference: 0 ft (0 m) [Outdoor unit - Indoor unit]
- The total ability of connected a indoor unit is up to 39,000 Btu from 27,000 Btu.
- Input in the table are calculated based on the maximum indoor unit input combinations.

● Cooling capacity in kW

TC: Total Capacity (kW), IP: Input Power (kW)

OUTDOOR UNIT
AOJ36RLXFZH

Indoor unit connecting capacity	Outdoor temperature	Indoor temperature											
		17.8 °CDB		21.1 °CDB		23.9 °CDB		26.7 °CDB		29.4 °CDB		32.2 °CDB	
		TC	IP	TC	IP	TC	IP	TC	IP	TC	IP	TC	IP
kBtu/h	°CDB												
39	-10.0	8.96	1.13	10.12	1.15	10.67	1.16	11.40	1.17	12.21	1.18	12.59	1.19
	-5.0	8.96	1.18	10.12	1.20	10.67	1.21	11.40	1.22	12.21	1.24	12.59	1.24
	0.0	8.96	1.23	10.12	1.25	10.67	1.26	11.40	1.28	12.21	1.29	12.59	1.30
	5.0	8.96	1.37	10.12	1.39	10.67	1.41	11.40	1.42	12.21	1.44	12.59	1.45
	10.0	8.96	1.51	10.12	1.54	10.67	1.55	11.40	1.57	12.21	1.59	12.59	1.59
	15.0	8.96	2.08	10.12	2.12	10.67	2.13	11.40	2.16	12.21	2.18	12.59	2.19
	20.0	8.96	2.65	10.12	2.69	10.67	2.72	11.40	2.75	12.21	2.78	12.59	2.79
	25.0	8.96	2.92	10.12	2.97	10.67	2.99	11.40	3.03	12.21	3.06	12.59	3.08
	30.0	8.96	3.19	10.12	3.24	10.67	3.27	11.40	3.31	12.21	3.34	12.59	3.36
	35.0	8.96	3.40	10.12	3.46	10.67	3.49	11.40	3.53	12.21	3.57	12.59	3.59
	40.0	8.47	3.71	9.58	3.78	10.10	3.81	10.80	3.85	11.56	3.89	11.91	3.92
46.1	7.99	4.02	9.03	4.09	9.52	4.12	10.20	4.17	10.90	4.22	11.24	4.24	
38	-10.0	8.96	1.13	10.12	1.15	10.67	1.16	11.40	1.17	12.21	1.18	12.59	1.19
	-5.0	8.96	1.18	10.12	1.20	10.67	1.21	11.40	1.22	12.21	1.24	12.59	1.24
	0.0	8.96	1.23	10.12	1.25	10.67	1.26	11.40	1.28	12.21	1.29	12.59	1.30
	5.0	8.96	1.37	10.12	1.39	10.67	1.41	11.40	1.42	12.21	1.44	12.59	1.45
	10.0	8.96	1.51	10.12	1.54	10.67	1.55	11.40	1.57	12.21	1.59	12.59	1.59
	15.0	8.96	2.08	10.12	2.12	10.67	2.13	11.40	2.16	12.21	2.18	12.59	2.19
	20.0	8.96	2.65	10.12	2.69	10.67	2.72	11.40	2.75	12.21	2.78	12.59	2.79
	25.0	8.96	2.92	10.12	2.97	10.67	2.99	11.40	3.03	12.21	3.06	12.59	3.08
	30.0	8.96	3.19	10.12	3.24	10.67	3.27	11.40	3.31	12.21	3.34	12.59	3.36
	35.0	8.96	3.40	10.12	3.46	10.67	3.49	11.40	3.53	12.21	3.57	12.59	3.59
	40.0	8.47	3.71	9.58	3.78	10.10	3.81	10.80	3.85	11.56	3.89	11.91	3.92
46.1	7.99	4.02	9.03	4.09	9.52	4.12	10.20	4.17	10.90	4.22	11.24	4.24	
37	-10.0	8.96	1.13	10.12	1.15	10.67	1.16	11.40	1.17	12.21	1.18	12.59	1.19
	-5.0	8.96	1.18	10.12	1.20	10.67	1.21	11.40	1.22	12.21	1.24	12.59	1.24
	0.0	8.96	1.23	10.12	1.25	10.67	1.26	11.40	1.28	12.21	1.29	12.59	1.30
	5.0	8.96	1.37	10.12	1.39	10.67	1.41	11.40	1.42	12.21	1.44	12.59	1.45
	10.0	8.96	1.51	10.12	1.54	10.67	1.55	11.40	1.57	12.21	1.59	12.59	1.59
	15.0	8.96	2.08	10.12	2.12	10.67	2.13	11.40	2.16	12.21	2.18	12.59	2.19
	20.0	8.96	2.65	10.12	2.69	10.67	2.72	11.40	2.75	12.21	2.78	12.59	2.79
	25.0	8.96	2.92	10.12	2.97	10.67	2.99	11.40	3.03	12.21	3.06	12.59	3.08
	30.0	8.96	3.19	10.12	3.24	10.67	3.27	11.40	3.31	12.21	3.34	12.59	3.36
	35.0	8.96	3.40	10.12	3.46	10.67	3.49	11.40	3.53	12.21	3.57	12.59	3.59
	40.0	8.47	3.71	9.58	3.78	10.10	3.81	10.80	3.85	11.56	3.89	11.91	3.92
46.1	7.99	4.02	9.03	4.09	9.52	4.12	10.20	4.17	10.90	4.22	11.24	4.24	
36	-10.0	8.96	1.13	10.12	1.15	10.67	1.16	11.40	1.17	12.21	1.18	12.59	1.19
	-5.0	8.96	1.18	10.12	1.20	10.67	1.21	11.40	1.22	12.21	1.24	12.59	1.24
	0.0	8.96	1.23	10.12	1.25	10.67	1.26	11.40	1.28	12.21	1.29	12.59	1.30
	5.0	8.96	1.37	10.12	1.39	10.67	1.41	11.40	1.42	12.21	1.44	12.59	1.45
	10.0	8.96	1.51	10.12	1.54	10.67	1.55	11.40	1.57	12.21	1.59	12.59	1.59
	15.0	8.96	2.08	10.12	2.12	10.67	2.13	11.40	2.16	12.21	2.18	12.59	2.19
	20.0	8.96	2.65	10.12	2.69	10.67	2.72	11.40	2.75	12.21	2.78	12.59	2.79
	25.0	8.96	2.92	10.12	2.97	10.67	2.99	11.40	3.03	12.21	3.06	12.59	3.08
	30.0	8.96	3.19	10.12	3.24	10.67	3.27	11.40	3.31	12.21	3.34	12.59	3.36
	35.0	8.96	3.40	10.12	3.46	10.67	3.49	11.40	3.53	12.21	3.57	12.59	3.59
	40.0	8.47	3.71	9.58	3.78	10.10	3.81	10.80	3.85	11.56	3.89	11.91	3.92
46.1	7.99	4.02	9.03	4.09	9.52	4.12	10.20	4.17	10.90	4.22	11.24	4.24	
35	-10.0	8.71	1.07	9.84	1.09	10.37	1.10	11.10	1.11	11.87	1.12	12.24	1.13
	-5.0	8.71	1.12	9.84	1.14	10.37	1.15	11.10	1.16	11.87	1.17	12.24	1.18
	0.0	8.71	1.17	9.84	1.19	10.37	1.20	11.10	1.21	11.87	1.22	12.24	1.23
	5.0	8.71	1.30	9.84	1.32	10.37	1.33	11.10	1.35	11.87	1.36	12.24	1.37
	10.0	8.71	1.43	9.84	1.46	10.37	1.47	11.10	1.49	11.87	1.50	12.24	1.51
	15.0	8.71	1.97	9.84	2.01	10.37	2.02	11.10	2.05	11.87	2.07	12.24	2.08
	20.0	8.71	2.51	9.84	2.56	10.37	2.58	11.10	2.61	11.87	2.63	12.24	2.65
	25.0	8.71	2.77	9.84	2.82	10.37	2.84	11.10	2.87	11.87	2.90	12.24	2.92
	30.0	8.71	3.02	9.84	3.08	10.37	3.10	11.10	3.14	11.87	3.17	12.24	3.19
	35.0	8.71	3.23	9.84	3.28	10.37	3.31	11.10	3.35	11.87	3.39	12.24	3.40
	40.0	8.24	3.52	9.31	3.58	9.82	3.61	10.50	3.65	11.24	3.69	11.58	3.71
46.1	8.24	3.81	9.31	3.88	9.82	3.91	10.50	3.96	11.24	4.00	11.58	4.02	
34	-10.0	8.46	1.03	9.56	1.05	10.08	1.05	10.70	1.07	11.54	1.08	11.89	1.08
	-5.0	8.46	1.07	9.56	1.09	10.08	1.10	10.70	1.11	11.54	1.13	11.89	1.13
	0.0	8.46	1.12	9.56	1.14	10.08	1.15	10.70	1.16	11.54	1.18	11.89	1.18
	5.0	8.46	1.25	9.56	1.27	10.08	1.28	10.70	1.30	11.54	1.31	11.89	1.32
	10.0	8.46	1.38	9.56	1.40	10.08	1.41	10.70	1.43	11.54	1.45	11.89	1.45
	15.0	8.46	1.90	9.56	1.93	10.08	1.94	10.70	1.97	11.54	1.99	11.89	2.00
	20.0	8.46	2.41	9.56	2.46	10.08	2.48	10.70	2.50	11.54	2.53	11.89	2.55
	25.0	8.46	2.66	9.56	2.71	10.08	2.73	10.70	2.76	11.54	2.79	11.89	2.81
	30.0	8.46	2.91	9.56	2.96	10.08	2.98	10.70	3.01	11.54	3.05	11.89	3.07
	35.0	8.46	3.10	9.56	3.16	10.08	3.18	10.70	3.22	11.54	3.26	11.89	3.27
	40.0	8.00	3.38	9.04	3.44	9.54	3.47	10.20	3.51	10.91	3.55	11.25	3.57
46.1	8.00	3.67	9.04	3.73	9.54	3.76	10.20	3.80	10.91	3.85	11.25	3.87	

Indoor unit connecting capacity	Outdoor temperature	Indoor temperature											
		17.8 °CDB		21.1 °CDB		23.9 °CDB		26.7 °CDB		29.4 °CDB		32.2 °CDB	
		12.2 °CWB		15.6 °CWB		17.2 °CWB		19.4 °CWB		21.7 °CWB		22.8 °CWB	
kBtu/h	°CDB	TC	IP	TC	IP	TC	IP	TC	IP	TC	IP	TC	IP
33	-10.0	8.21	0.99	9.28	1.00	9.78	1.01	10.40	1.02	11.20	1.03	11.54	1.04
	-5.0	8.21	1.03	9.28	1.05	9.78	1.06	10.40	1.07	11.20	1.08	11.54	1.09
	0.0	8.21	1.08	9.28	1.09	9.78	1.10	10.40	1.12	11.20	1.13	11.54	1.14
	5.0	8.21	1.20	9.28	1.22	9.78	1.23	10.40	1.24	11.20	1.26	11.54	1.26
	10.0	8.21	1.32	9.28	1.35	9.78	1.36	10.40	1.37	11.20	1.39	11.54	1.39
	15.0	8.21	1.82	9.28	1.85	9.78	1.87	10.40	1.89	11.20	1.91	11.54	1.92
	20.0	8.21	2.32	9.28	2.36	9.78	2.38	10.40	2.40	11.20	2.43	11.54	2.44
	25.0	8.21	2.55	9.28	2.60	9.78	2.62	10.40	2.65	11.20	2.68	11.54	2.69
	30.0	8.21	2.79	9.28	2.84	9.78	2.86	10.40	2.89	11.20	2.93	11.54	2.94
	35.0	8.21	2.98	9.28	3.03	9.78	3.05	10.40	3.09	11.20	3.12	11.54	3.14
40.0	7.77	3.25	8.78	3.30	9.25	3.33	9.90	3.37	10.59	3.41	10.92	3.43	
	46.1	7.77	3.52	8.78	3.58	9.25	3.61	9.90	3.65	10.59	3.69	10.92	3.71
32	-10.0	7.96	0.94	9.00	0.96	9.48	0.97	10.10	0.98	10.86	0.99	11.19	1.00
	-5.0	7.96	0.99	9.00	1.01	9.48	1.01	10.10	1.02	10.86	1.04	11.19	1.04
	0.0	7.96	1.03	9.00	1.05	9.48	1.06	10.10	1.07	10.86	1.08	11.19	1.09
	5.0	7.96	1.15	9.00	1.17	9.48	1.18	10.10	1.19	10.86	1.21	11.19	1.21
	10.0	7.96	1.27	9.00	1.29	9.48	1.30	10.10	1.31	10.86	1.33	11.19	1.34
	15.0	7.96	1.74	9.00	1.77	9.48	1.79	10.10	1.81	10.86	1.83	11.19	1.84
	20.0	7.96	2.22	9.00	2.26	9.48	2.28	10.10	2.30	10.86	2.33	11.19	2.34
	25.0	7.96	2.45	9.00	2.49	9.48	2.51	10.10	2.54	10.86	2.57	11.19	2.58
	30.0	7.96	2.67	9.00	2.72	9.48	2.74	10.10	2.77	10.86	2.80	11.19	2.82
	35.0	7.96	2.85	9.00	2.90	9.48	2.93	10.10	2.96	10.86	2.99	11.19	3.01
40.0	7.53	3.11	8.51	3.17	8.97	3.19	9.60	3.23	10.27	3.26	10.59	3.28	
	46.1	7.53	3.37	8.51	3.43	8.97	3.46	9.60	3.50	10.27	3.54	10.59	3.56
31	-10.0	7.71	0.90	8.72	0.92	9.19	0.93	9.80	0.94	10.52	0.95	10.84	0.95
	-5.0	7.71	0.94	8.72	0.96	9.19	0.97	9.80	0.98	10.52	0.99	10.84	1.00
	0.0	7.71	0.99	8.72	1.00	9.19	1.01	9.80	1.02	10.52	1.03	10.84	1.04
	5.0	7.71	1.10	8.72	1.12	9.19	1.13	9.80	1.14	10.52	1.15	10.84	1.16
	10.0	7.71	1.21	8.72	1.23	9.19	1.24	9.80	1.26	10.52	1.27	10.84	1.28
	15.0	7.71	1.67	8.72	1.70	9.19	1.71	9.80	1.73	10.52	1.75	10.84	1.76
	20.0	7.71	2.12	8.72	2.16	9.19	2.18	9.80	2.20	10.52	2.23	10.84	2.24
	25.0	7.71	2.34	8.72	2.38	9.19	2.40	9.80	2.43	10.52	2.45	10.84	2.47
	30.0	7.71	2.55	8.72	2.60	9.19	2.62	9.80	2.65	10.52	2.68	10.84	2.69
	35.0	7.71	2.73	8.72	2.78	9.19	2.80	9.80	2.83	10.52	2.86	10.84	2.88
40.0	7.30	2.97	8.25	3.03	8.69	3.05	9.30	3.09	9.95	3.12	10.26	3.14	
	46.1	7.30	3.22	8.25	3.28	8.69	3.31	9.30	3.34	9.95	3.38	10.26	3.40
30	-10.0	7.46	0.86	8.43	0.88	8.89	0.88	9.50	0.89	10.18	0.90	10.49	0.91
	-5.0	7.46	0.90	8.43	0.92	8.89	0.92	9.50	0.93	10.18	0.95	10.49	0.95
	0.0	7.46	0.94	8.43	0.96	8.89	0.96	9.50	0.98	10.18	0.99	10.49	0.99
	5.0	7.46	1.05	8.43	1.07	8.89	1.08	9.50	1.09	10.18	1.10	10.49	1.11
	10.0	7.46	1.16	8.43	1.18	8.89	1.19	9.50	1.20	10.18	1.21	10.49	1.22
	15.0	7.46	1.59	8.43	1.62	8.89	1.63	9.50	1.65	10.18	1.67	10.49	1.68
	20.0	7.46	2.03	8.43	2.06	8.89	2.08	9.50	2.10	10.18	2.12	10.49	2.14
	25.0	7.46	2.23	8.43	2.27	8.89	2.29	9.50	2.31	10.18	2.34	10.49	2.35
	30.0	7.46	2.44	8.43	2.48	8.89	2.50	9.50	2.53	10.18	2.56	10.49	2.57
	35.0	7.46	2.60	8.43	2.65	8.89	2.67	9.50	2.70	10.18	2.73	10.49	2.75
40.0	7.06	2.84	7.98	2.89	8.41	2.91	9.00	2.94	9.63	2.98	9.93	2.99	
	46.1	7.06	3.07	7.98	3.13	8.41	3.15	9.00	3.19	9.63	3.23	9.93	3.24
29	-10.0	7.21	0.82	8.15	0.83	8.59	0.84	9.20	0.85	9.84	0.86	10.14	0.87
	-5.0	7.21	0.86	8.15	0.87	8.59	0.88	9.20	0.89	9.84	0.90	10.14	0.91
	0.0	7.21	0.90	8.15	0.91	8.59	0.92	9.20	0.93	9.84	0.94	10.14	0.94
	5.0	7.21	1.00	8.15	1.02	8.59	1.02	9.20	1.04	9.84	1.05	10.14	1.05
	10.0	7.21	1.10	8.15	1.12	8.59	1.13	9.20	1.14	9.84	1.15	10.14	1.16
	15.0	7.21	1.51	8.15	1.54	8.59	1.55	9.20	1.57	9.84	1.59	10.14	1.60
	20.0	7.21	1.93	8.15	1.96	8.59	1.98	9.20	2.00	9.84	2.02	10.14	2.03
	25.0	7.21	2.12	8.15	2.16	8.59	2.18	9.20	2.20	9.84	2.23	10.14	2.24
	30.0	7.21	2.32	8.15	2.36	8.59	2.38	9.20	2.41	9.84	2.43	10.14	2.45
	35.0	7.21	2.48	8.15	2.52	8.59	2.54	9.20	2.57	9.84	2.60	10.14	2.61
40.0	6.83	2.70	7.71	2.75	8.13	2.77	8.70	2.80	9.31	2.84	9.60	2.85	
	46.1	6.83	2.93	7.71	2.98	8.13	3.00	8.70	3.04	9.31	3.07	9.60	3.09
28	-10.0	6.96	0.78	7.87	0.79	8.30	0.80	8.80	0.81	9.50	0.82	9.79	0.82
	-5.0	6.96	0.81	7.87	0.83	8.30	0.84	8.80	0.85	9.50	0.85	9.79	0.86
	0.0	6.96	0.85	7.87	0.87	8.30	0.87	8.80	0.88	9.50	0.89	9.79	0.90
	5.0	6.96	0.95	7.87	0.96	8.30	0.97	8.80	0.98	9.50	0.99	9.79	1.00
	10.0	6.96	1.04	7.87	1.06	8.30	1.07	8.80	1.08	9.50	1.10	9.79	1.10
	15.0	6.96	1.44	7.87	1.46	8.30	1.47	8.80	1.49	9.50	1.51	9.79	1.52
	20.0	6.96	1.83	7.87	1.86	8.30	1.88	8.80	1.90	9.50	1.92	9.79	1.93
	25.0	6.96	2.02	7.87	2.05	8.30	2.07	8.80	2.09	9.50	2.12	9.79	2.13
	30.0	6.96	2.20	7.87	2.24	8.30	2.26	8.80	2.29	9.50	2.31	9.79	2.32
	35.0	6.96	2.35	7.87	2.39	8.30	2.41	8.80	2.44	9.50	2.47	9.79	2.48
40.0	6.59	2.57	7.45	2.61	7.85	2.63	8.40	2.66	8.99	2.69	9.26	2.71	
	46.1	6.59	2.78	7.45	2.83	7.85	2.85	8.40	2.88	8.99	2.92	9.26	2.93

**OUTDOOR UNIT
AOU36RLXFZH**

Indoor unit connecting capacity	Outdoor temperature	Indoor temperature											
		17.8 °CDB		21.1 °CDB		23.9 °CDB		26.7 °CDB		29.4 °CDB		32.2 °CDB	
		12.2 °CWB		15.6 °CWB		17.2 °CWB		19.4 °CWB		21.7 °CWB		22.8 °CWB	
kBtu/h	°CDB	TC	IP	TC	IP	TC	IP	TC	IP	TC	IP	TC	IP
27	-10.0	6.72	0.74	7.59	0.75	8.00	0.76	8.50	0.77	9.16	0.77	9.44	0.78
	-5.0	6.72	0.77	7.59	0.79	8.00	0.79	8.50	0.80	9.16	0.81	9.44	0.81
	0.0	6.72	0.81	7.59	0.82	8.00	0.83	8.50	0.84	9.16	0.84	9.44	0.85
	5.0	6.72	0.90	7.59	0.91	8.00	0.92	8.50	0.93	9.16	0.94	9.44	0.95
	10.0	6.72	0.99	7.59	1.01	8.00	1.01	8.50	1.03	9.16	1.04	9.44	1.04
	15.0	6.72	1.36	7.59	1.39	8.00	1.40	8.50	1.41	9.16	1.43	9.44	1.44
	20.0	6.72	1.73	7.59	1.76	8.00	1.78	8.50	1.80	9.16	1.82	9.44	1.83
	25.0	6.72	1.91	7.59	1.94	8.00	1.96	8.50	1.98	9.16	2.00	9.44	2.02
	30.0	6.72	2.09	7.59	2.12	8.00	2.14	8.50	2.16	9.16	2.19	9.44	2.20
	35.0	6.72	2.23	7.59	2.27	8.00	2.29	8.50	2.31	9.16	2.34	9.44	2.35
	40.0	6.35	2.43	7.18	2.47	7.57	2.49	8.10	2.52	8.67	2.55	8.93	2.56
46.1	6.35	2.63	7.18	2.68	7.57	2.70	8.10	2.73	8.67	2.76	8.93	2.78	

NOTE:

Specifications are based on the following conditions.

- Power source of specifications: 230 V
- 2 or more indoor units should be connected.
- Pipe length: 24.6 ft (7.5 m), Height difference: 0 ft (0 m) [Outdoor unit - Indoor unit]
- The total ability of connected a indoor unit is up to 39,000 Btu from 27,000 Btu.
- Input in the table are calculated based on the maximum indoor unit input combinations.

■ Compact cassette type

● Cooling capacity in kBtu/h

- TC: Total Capacity (kBtu/h), SHC: Sensible Heat Capacity (kBtu/h).
- The data is based on the following conditions:
Pipe length: 24.6 ft (7.5 m), Height difference: 0 ft (0 m) [Outdoor unit - Indoor unit]

MODEL: AUU7RLF

Outdoor temperature (°FDB)	Indoor temperature (°FDB / °FWB)											
	64.0 / 54.0		70.0 / 60.0		75.0 / 63.0		80.0 / 67.0		85.0 / 71.0		90.0 / 73.0	
	TC	SHC	TC	SHC	TC	SHC	TC	SHC	TC	SHC	TC	SHC
14.0	5.96	4.02	6.73	4.58	7.10	5.28	7.60	5.93	8.12	6.48	8.38	7.43
23.0	5.96	4.02	6.73	4.58	7.10	5.28	7.60	5.93	8.12	6.48	8.38	7.43
32.0	5.96	4.02	6.73	4.58	7.10	5.28	7.60	5.93	8.12	6.48	8.38	7.43
41.0	5.96	4.02	6.73	4.58	7.10	5.28	7.60	5.93	8.12	6.48	8.38	7.43
50.0	5.96	4.02	6.73	4.58	7.10	5.28	7.60	5.93	8.12	6.48	8.38	7.43
59.0	5.96	4.02	6.73	4.58	7.10	5.28	7.60	5.93	8.12	6.48	8.38	7.43
67.0	5.96	4.02	6.73	4.58	7.10	5.28	7.60	5.93	8.12	6.48	8.38	7.43
77.0	5.96	4.02	6.73	4.58	7.10	5.28	7.60	5.93	8.12	6.48	8.38	7.43
87.0	5.96	4.02	6.73	4.58	7.10	5.28	7.60	5.93	8.12	6.48	8.38	7.43
95.0	5.96	4.02	6.73	4.58	7.10	5.28	7.60	5.93	8.12	6.48	8.38	7.43
104.0	5.64	3.60	6.37	4.10	6.72	4.72	7.19	5.31	7.69	5.80	7.92	6.65
115.0	5.32	3.20	6.01	3.65	6.33	4.20	6.78	4.72	7.25	5.16	7.47	5.92

MODEL: AUU9RLF

Outdoor temperature (°FDB)	Indoor temperature (°FDB / °FWB)											
	64.0 / 54.0		70.0 / 60.0		75.0 / 63.0		80.0 / 67.0		85.0 / 71.0		90.0 / 73.0	
	TC	SHC	TC	SHC	TC	SHC	TC	SHC	TC	SHC	TC	SHC
14.0	7.68	5.12	8.68	5.83	9.15	6.72	9.80	7.55	10.48	8.25	10.80	9.46
23.0	7.68	5.12	8.68	5.83	9.15	6.72	9.80	7.55	10.48	8.25	10.80	9.46
32.0	7.68	5.12	8.68	5.83	9.15	6.72	9.80	7.55	10.48	8.25	10.80	9.46
41.0	7.68	5.12	8.68	5.83	9.15	6.72	9.80	7.55	10.48	8.25	10.80	9.46
50.0	7.68	5.12	8.68	5.83	9.15	6.72	9.80	7.55	10.48	8.25	10.80	9.46
59.0	7.68	5.12	8.68	5.83	9.15	6.72	9.80	7.55	10.48	8.25	10.80	9.46
67.0	7.68	5.12	8.68	5.83	9.15	6.72	9.80	7.55	10.48	8.25	10.80	9.46
77.0	7.68	5.12	8.68	5.83	9.15	6.72	9.80	7.55	10.48	8.25	10.80	9.46
87.0	7.68	5.12	8.68	5.83	9.15	6.72	9.80	7.55	10.48	8.25	10.80	9.46
95.0	7.68	5.12	8.68	5.83	9.15	6.72	9.80	7.55	10.48	8.25	10.80	9.46
104.0	7.27	4.58	8.22	5.22	8.66	6.01	9.27	6.76	9.91	7.39	10.22	8.47
115.0	6.86	4.08	7.75	4.65	8.17	5.35	8.75	6.01	9.35	6.57	9.64	7.53

MODEL: AUU12RLF

Outdoor temperature (°FDB)	Indoor temperature (°FDB / °FWB)											
	64.0 / 54.0		70.0 / 60.0		75.0 / 63.0		80.0 / 67.0		85.0 / 71.0		90.0 / 73.0	
	TC	SHC	TC	SHC	TC	SHC	TC	SHC	TC	SHC	TC	SHC
14.0	10.19	6.70	11.52	7.64	12.14	8.79	13.00	9.88	13.90	10.81	14.33	12.38
23.0	10.19	6.70	11.52	7.64	12.14	8.79	13.00	9.88	13.90	10.81	14.33	12.38
32.0	10.19	6.70	11.52	7.64	12.14	8.79	13.00	9.88	13.90	10.81	14.33	12.38
41.0	10.19	6.70	11.52	7.64	12.14	8.79	13.00	9.88	13.90	10.81	14.33	12.38
50.0	10.19	6.70	11.52	7.64	12.14	8.79	13.00	9.88	13.90	10.81	14.33	12.38
59.0	10.19	6.70	11.52	7.64	12.14	8.79	13.00	9.88	13.90	10.81	14.33	12.38
67.0	10.19	6.70	11.52	7.64	12.14	8.79	13.00	9.88	13.90	10.81	14.33	12.38
77.0	10.19	6.70	11.52	7.64	12.14	8.79	13.00	9.88	13.90	10.81	14.33	12.38
87.0	10.19	6.70	11.52	7.64	12.14	8.79	13.00	9.88	13.90	10.81	14.33	12.38
95.0	10.19	6.70	11.52	7.64	12.14	8.79	13.00	9.88	13.90	10.81	14.33	12.38
104.0	9.64	6.00	10.90	6.84	11.49	7.87	12.30	8.85	13.15	9.67	13.56	11.08
115.0	9.10	5.34	10.28	6.08	10.84	7.00	11.60	7.87	12.40	8.61	12.78	9.86

MODEL: AUU18RLF

**OUTDOOR UNIT
 AOU36RLXZFH**

Outdoor temperature (°FDB)	Indoor temperature (°FDB / °FWB)											
	64.0 / 54.0		70.0 / 60.0		75.0 / 63.0		80.0 / 67.0		85.0 / 71.0		90.0 / 73.0	
	TC	SHC	TC	SHC	TC	SHC	TC	SHC	TC	SHC	TC	SHC
14.0	15.29	9.26	17.28	10.55	18.21	12.15	19.50	13.65	20.85	14.93	21.49	17.10
23.0	15.29	9.26	17.28	10.55	18.21	12.15	19.50	13.65	20.85	14.93	21.49	17.10
32.0	15.29	9.26	17.28	10.55	18.21	12.15	19.50	13.65	20.85	14.93	21.49	17.10
41.0	15.29	9.26	17.28	10.55	18.21	12.15	19.50	13.65	20.85	14.93	21.49	17.10
50.0	15.29	9.26	17.28	10.55	18.21	12.15	19.50	13.65	20.85	14.93	21.49	17.10
59.0	15.29	9.26	17.28	10.55	18.21	12.15	19.50	13.65	20.85	14.93	21.49	17.10
67.0	15.29	9.26	17.28	10.55	18.21	12.15	19.50	13.65	20.85	14.93	21.49	17.10
77.0	15.29	9.26	17.28	10.55	18.21	12.15	19.50	13.65	20.85	14.93	21.49	17.10
87.0	15.29	9.26	17.28	10.55	18.21	12.15	19.50	13.65	20.85	14.93	21.49	17.10
95.0	15.29	9.26	17.28	10.55	18.21	12.15	19.50	13.65	20.85	14.93	21.49	17.10
104.0	14.47	8.29	16.35	9.45	17.23	10.88	18.45	12.22	19.72	13.37	20.33	15.31
115.0	13.64	7.37	15.42	8.40	16.25	9.67	17.40	10.87	18.60	11.89	19.18	13.62

● Cooling capacity in kW

- TC: Total Capacity (kW), SHC: Sensible Heat Capacity (kW).
- The data is based on the following conditions:
Pipe length: 24.6 ft (7.5 m), Height difference: 0 ft (0 m) [Outdoor unit - Indoor unit]

MODEL: AUU7RLF

Outdoor temperature (°CDB)	Indoor temperature (°CDB / °CWB)											
	17.8 / 12.2		21.1 / 15.6		23.9 / 17.2		26.7 / 19.4		29.4 / 21.7		32.2 / 22.8	
	TC	SHC	TC	SHC	TC	SHC	TC	SHC	TC	SHC	TC	SHC
-10.0	1.75	1.18	1.97	1.34	2.08	1.55	2.23	1.74	2.38	1.90	2.45	2.18
-5.0	1.75	1.18	1.97	1.34	2.08	1.55	2.23	1.74	2.38	1.90	2.45	2.18
0.0	1.75	1.18	1.97	1.34	2.08	1.55	2.23	1.74	2.38	1.90	2.45	2.18
5.0	1.75	1.18	1.97	1.34	2.08	1.55	2.23	1.74	2.38	1.90	2.45	2.18
10.0	1.75	1.18	1.97	1.34	2.08	1.55	2.23	1.74	2.38	1.90	2.45	2.18
15.0	1.75	1.18	1.97	1.34	2.08	1.55	2.23	1.74	2.38	1.90	2.45	2.18
20.0	1.75	1.18	1.97	1.34	2.08	1.55	2.23	1.74	2.38	1.90	2.45	2.18
25.0	1.75	1.18	1.97	1.34	2.08	1.55	2.23	1.74	2.38	1.90	2.45	2.18
30.0	1.75	1.18	1.97	1.34	2.08	1.55	2.23	1.74	2.38	1.90	2.45	2.18
35.0	1.75	1.18	1.97	1.34	2.08	1.55	2.23	1.74	2.38	1.90	2.45	2.18
40.0	1.65	1.05	1.87	1.20	1.97	1.38	2.11	1.56	2.25	1.70	2.32	1.95
46.1	1.56	0.94	1.76	1.07	1.86	1.23	1.99	1.38	2.12	1.51	2.19	1.73

MODEL: AUU9RLF

Outdoor temperature (°CDB)	Indoor temperature (°CDB / °CWB)											
	17.8 / 12.2		21.1 / 15.6		23.9 / 17.2		26.7 / 19.4		29.4 / 21.7		32.2 / 22.8	
	TC	SHC	TC	SHC	TC	SHC	TC	SHC	TC	SHC	TC	SHC
-10.0	2.25	1.50	2.54	1.71	2.68	1.97	2.87	2.21	3.07	2.42	3.17	2.77
-5.0	2.25	1.50	2.54	1.71	2.68	1.97	2.87	2.21	3.07	2.42	3.17	2.77
0.0	2.25	1.50	2.54	1.71	2.68	1.97	2.87	2.21	3.07	2.42	3.17	2.77
5.0	2.25	1.50	2.54	1.71	2.68	1.97	2.87	2.21	3.07	2.42	3.17	2.77
10.0	2.25	1.50	2.54	1.71	2.68	1.97	2.87	2.21	3.07	2.42	3.17	2.77
15.0	2.25	1.50	2.54	1.71	2.68	1.97	2.87	2.21	3.07	2.42	3.17	2.77
20.0	2.25	1.50	2.54	1.71	2.68	1.97	2.87	2.21	3.07	2.42	3.17	2.77
25.0	2.25	1.50	2.54	1.71	2.68	1.97	2.87	2.21	3.07	2.42	3.17	2.77
30.0	2.25	1.50	2.54	1.71	2.68	1.97	2.87	2.21	3.07	2.42	3.17	2.77
35.0	2.25	1.50	2.54	1.71	2.68	1.97	2.87	2.21	3.07	2.42	3.17	2.77
40.0	2.13	1.34	2.41	1.53	2.54	1.76	2.72	1.98	2.91	2.17	2.99	2.48
46.1	2.01	1.19	2.27	1.36	2.39	1.57	2.56	1.76	2.74	1.93	2.82	2.21

MODEL: AUU12RLF

Outdoor temperature (°CDB)	Indoor temperature (°CDB / °CWB)											
	17.8 / 12.2		21.1 / 15.6		23.9 / 17.2		26.7 / 19.4		29.4 / 21.7		32.2 / 22.8	
	TC	SHC	TC	SHC	TC	SHC	TC	SHC	TC	SHC	TC	SHC
-10.0	2.99	1.96	3.38	2.24	3.56	2.58	3.81	2.90	4.07	3.17	4.20	3.63
-5.0	2.99	1.96	3.38	2.24	3.56	2.58	3.81	2.90	4.07	3.17	4.20	3.63
0.0	2.99	1.96	3.38	2.24	3.56	2.58	3.81	2.90	4.07	3.17	4.20	3.63
5.0	2.99	1.96	3.38	2.24	3.56	2.58	3.81	2.90	4.07	3.17	4.20	3.63
10.0	2.99	1.96	3.38	2.24	3.56	2.58	3.81	2.90	4.07	3.17	4.20	3.63
15.0	2.99	1.96	3.38	2.24	3.56	2.58	3.81	2.90	4.07	3.17	4.20	3.63
20.0	2.99	1.96	3.38	2.24	3.56	2.58	3.81	2.90	4.07	3.17	4.20	3.63
25.0	2.99	1.96	3.38	2.24	3.56	2.58	3.81	2.90	4.07	3.17	4.20	3.63
30.0	2.99	1.96	3.38	2.24	3.56	2.58	3.81	2.90	4.07	3.17	4.20	3.63
35.0	2.99	1.96	3.38	2.24	3.56	2.58	3.81	2.90	4.07	3.17	4.20	3.63
40.0	2.83	1.76	3.19	2.00	3.37	2.31	3.61	2.59	3.85	2.84	3.97	3.25
46.1	2.67	1.56	3.01	1.78	3.18	2.05	3.40	2.31	3.63	2.52	3.75	2.89

MODEL: AUU18RLF

**OUTDOOR UNIT
 AOU36RLXZFH**

Outdoor temperature (°CDB)	Indoor temperature (°CDB / °CWB)											
	17.8 / 12.2		21.1 / 15.6		23.9 / 17.2		26.7 / 19.4		29.4 / 21.7		32.2 / 22.8	
	TC	SHC	TC	SHC	TC	SHC	TC	SHC	TC	SHC	TC	SHC
-10.0	4.48	2.71	5.06	3.09	5.34	3.56	5.72	4.00	6.11	4.38	6.30	5.01
-5.0	4.48	2.71	5.06	3.09	5.34	3.56	5.72	4.00	6.11	4.38	6.30	5.01
0.0	4.48	2.71	5.06	3.09	5.34	3.56	5.72	4.00	6.11	4.38	6.30	5.01
5.0	4.48	2.71	5.06	3.09	5.34	3.56	5.72	4.00	6.11	4.38	6.30	5.01
10.0	4.48	2.71	5.06	3.09	5.34	3.56	5.72	4.00	6.11	4.38	6.30	5.01
15.0	4.48	2.71	5.06	3.09	5.34	3.56	5.72	4.00	6.11	4.38	6.30	5.01
20.0	4.48	2.71	5.06	3.09	5.34	3.56	5.72	4.00	6.11	4.38	6.30	5.01
25.0	4.48	2.71	5.06	3.09	5.34	3.56	5.72	4.00	6.11	4.38	6.30	5.01
30.0	4.48	2.71	5.06	3.09	5.34	3.56	5.72	4.00	6.11	4.38	6.30	5.01
35.0	4.48	2.71	5.06	3.09	5.34	3.56	5.72	4.00	6.11	4.38	6.30	5.01
40.0	4.24	2.43	4.79	2.77	5.05	3.19	5.41	3.58	5.78	3.92	5.96	4.49
46.1	4.00	2.16	4.52	2.46	4.76	2.84	5.10	3.19	5.45	3.48	5.62	3.99

■ Slim duct type

● Cooling capacity in kBtu/h

- TC: Total Capacity (kBtu/h), SHC: Sensible Heat Capacity (kBtu/h).
- The data is based on the following conditions.
- Pipe length: 24.6 ft (7.5 m), Height difference: 0 ft (0 m) [Outdoor unit - Indoor unit]

MODEL: ARU7RLF

Outdoor temperature (°FDB)	Indoor temperature (°FDB / °FWB)											
	64.0 / 54.0		70.0 / 60.0		75.0 / 63.0		80.0 / 67.0		85.0 / 71.0		90.0 / 73.0	
	TC	SHC	TC	SHC	TC	SHC	TC	SHC	TC	SHC	TC	SHC
14.0	5.96	4.12	6.73	4.70	7.10	5.41	7.60	6.08	8.12	6.65	8.38	7.62
23.0	5.96	4.12	6.73	4.70	7.10	5.41	7.60	6.08	8.12	6.65	8.38	7.62
32.0	5.96	4.12	6.73	4.70	7.10	5.41	7.60	6.08	8.12	6.65	8.38	7.62
41.0	5.96	4.12	6.73	4.70	7.10	5.41	7.60	6.08	8.12	6.65	8.38	7.62
50.0	5.96	4.12	6.73	4.70	7.10	5.41	7.60	6.08	8.12	6.65	8.38	7.62
59.0	5.96	4.12	6.73	4.70	7.10	5.41	7.60	6.08	8.12	6.65	8.38	7.62
67.0	5.96	4.12	6.73	4.70	7.10	5.41	7.60	6.08	8.12	6.65	8.38	7.62
77.0	5.96	4.12	6.73	4.70	7.10	5.41	7.60	6.08	8.12	6.65	8.38	7.62
87.0	5.96	4.12	6.73	4.70	7.10	5.41	7.60	6.08	8.12	6.65	8.38	7.62
95.0	5.96	4.12	6.73	4.70	7.10	5.41	7.60	6.08	8.12	6.65	8.38	7.62
104.0	5.64	3.69	6.37	4.21	6.72	4.84	7.19	5.44	7.69	5.95	7.92	6.82
115.0	5.32	3.28	6.01	3.74	6.33	4.31	6.78	4.84	7.25	5.30	7.47	6.07

MODEL: ARU9RLF

Outdoor temperature (°FDB)	Indoor temperature (°FDB / °FWB)											
	64.0 / 54.0		70.0 / 60.0		75.0 / 63.0		80.0 / 67.0		85.0 / 71.0		90.0 / 73.0	
	TC	SHC	TC	SHC	TC	SHC	TC	SHC	TC	SHC	TC	SHC
14.0	7.68	4.92	8.68	5.61	9.15	6.45	9.80	7.25	10.48	7.93	10.80	9.09
23.0	7.68	4.92	8.68	5.61	9.15	6.45	9.80	7.25	10.48	7.93	10.80	9.09
32.0	7.68	4.92	8.68	5.61	9.15	6.45	9.80	7.25	10.48	7.93	10.80	9.09
41.0	7.68	4.92	8.68	5.61	9.15	6.45	9.80	7.25	10.48	7.93	10.80	9.09
50.0	7.68	4.92	8.68	5.61	9.15	6.45	9.80	7.25	10.48	7.93	10.80	9.09
59.0	7.68	4.92	8.68	5.61	9.15	6.45	9.80	7.25	10.48	7.93	10.80	9.09
67.0	7.68	4.92	8.68	5.61	9.15	6.45	9.80	7.25	10.48	7.93	10.80	9.09
77.0	7.68	4.92	8.68	5.61	9.15	6.45	9.80	7.25	10.48	7.93	10.80	9.09
87.0	7.68	4.92	8.68	5.61	9.15	6.45	9.80	7.25	10.48	7.93	10.80	9.09
95.0	7.68	4.92	8.68	5.61	9.15	6.45	9.80	7.25	10.48	7.93	10.80	9.09
104.0	7.27	4.40	8.22	5.02	8.66	5.78	9.27	6.49	9.91	7.10	10.22	8.14
115.0	6.86	3.92	7.75	4.46	8.17	5.14	8.75	5.77	9.35	6.32	9.64	7.24

MODEL: ARU12RLF

Outdoor temperature (°FDB)	Indoor temperature (°FDB / °FWB)											
	64.0 / 54.0		70.0 / 60.0		75.0 / 63.0		80.0 / 67.0		85.0 / 71.0		90.0 / 73.0	
	TC	SHC	TC	SHC	TC	SHC	TC	SHC	TC	SHC	TC	SHC
14.0	10.19	6.52	11.52	7.44	12.14	8.56	13.00	9.62	13.90	10.52	14.33	12.05
23.0	10.19	6.52	11.52	7.44	12.14	8.56	13.00	9.62	13.90	10.52	14.33	12.05
32.0	10.19	6.52	11.52	7.44	12.14	8.56	13.00	9.62	13.90	10.52	14.33	12.05
41.0	10.19	6.52	11.52	7.44	12.14	8.56	13.00	9.62	13.90	10.52	14.33	12.05
50.0	10.19	6.52	11.52	7.44	12.14	8.56	13.00	9.62	13.90	10.52	14.33	12.05
59.0	10.19	6.52	11.52	7.44	12.14	8.56	13.00	9.62	13.90	10.52	14.33	12.05
67.0	10.19	6.52	11.52	7.44	12.14	8.56	13.00	9.62	13.90	10.52	14.33	12.05
77.0	10.19	6.52	11.52	7.44	12.14	8.56	13.00	9.62	13.90	10.52	14.33	12.05
87.0	10.19	6.52	11.52	7.44	12.14	8.56	13.00	9.62	13.90	10.52	14.33	12.05
95.0	10.19	6.52	11.52	7.44	12.14	8.56	13.00	9.62	13.90	10.52	14.33	12.05
104.0	9.64	5.84	10.90	6.66	11.49	7.67	12.30	8.61	13.15	9.42	13.56	10.79
115.0	9.10	5.20	10.28	5.92	10.84	6.82	11.60	7.66	12.40	8.38	12.78	9.60

MODEL: ARU18RLF

Outdoor temperature (°FDB)	Indoor temperature (°FDB / °FWB)											
	64.0 / 54.0		70.0 / 60.0		75.0 / 63.0		80.0 / 67.0		85.0 / 71.0		90.0 / 73.0	
	TC	SHC	TC	SHC	TC	SHC	TC	SHC	TC	SHC	TC	SHC
14.0	15.29	9.52	17.28	10.85	18.21	12.50	19.50	14.04	20.85	15.36	21.49	17.59
23.0	15.29	9.52	17.28	10.85	18.21	12.50	19.50	14.04	20.85	15.36	21.49	17.59
32.0	15.29	9.52	17.28	10.85	18.21	12.50	19.50	14.04	20.85	15.36	21.49	17.59
41.0	15.29	9.52	17.28	10.85	18.21	12.50	19.50	14.04	20.85	15.36	21.49	17.59
50.0	15.29	9.52	17.28	10.85	18.21	12.50	19.50	14.04	20.85	15.36	21.49	17.59
59.0	15.29	9.52	17.28	10.85	18.21	12.50	19.50	14.04	20.85	15.36	21.49	17.59
67.0	15.29	9.52	17.28	10.85	18.21	12.50	19.50	14.04	20.85	15.36	21.49	17.59
77.0	15.29	9.52	17.28	10.85	18.21	12.50	19.50	14.04	20.85	15.36	21.49	17.59
87.0	15.29	9.52	17.28	10.85	18.21	12.50	19.50	14.04	20.85	15.36	21.49	17.59
95.0	15.29	9.52	17.28	10.85	18.21	12.50	19.50	14.04	20.85	15.36	21.49	17.59
104.0	14.47	8.52	16.35	9.72	17.23	11.19	18.45	12.57	19.72	13.75	20.33	15.75
115.0	13.64	7.58	15.42	8.64	16.25	9.95	17.40	11.18	18.60	12.23	19.18	14.01

OUTDOOR UNIT
AOU36RLXFZH

MODEL: ARU24RLF

Outdoor temperature (°FDB)	Indoor temperature (°FDB / °FWB)											
	64.0 / 54.0		70.0 / 60.0		75.0 / 63.0		80.0 / 67.0		85.0 / 71.0		90.0 / 73.0	
	TC	SHC	TC	SHC	TC	SHC	TC	SHC	TC	SHC	TC	SHC
14.0	19.29	11.68	21.80	13.31	22.98	15.33	24.60	17.22	26.30	18.83	27.11	21.58
23.0	19.29	11.68	21.80	13.31	22.98	15.33	24.60	17.22	26.30	18.83	27.11	21.58
32.0	19.29	11.68	21.80	13.31	22.98	15.33	24.60	17.22	26.30	18.83	27.11	21.58
41.0	19.29	11.68	21.80	13.31	22.98	15.33	24.60	17.22	26.30	18.83	27.11	21.58
50.0	19.29	11.68	21.80	13.31	22.98	15.33	24.60	17.22	26.30	18.83	27.11	21.58
59.0	19.29	11.68	21.80	13.31	22.98	15.33	24.60	17.22	26.30	18.83	27.11	21.58
67.0	19.29	11.68	21.80	13.31	22.98	15.33	24.60	17.22	26.30	18.83	27.11	21.58
77.0	19.29	11.68	21.80	13.31	22.98	15.33	24.60	17.22	26.30	18.83	27.11	21.58
87.0	19.29	11.68	21.80	13.31	22.98	15.33	24.60	17.22	26.30	18.83	27.11	21.58
95.0	19.29	11.68	21.80	13.31	22.98	15.33	24.60	17.22	26.30	18.83	27.11	21.58
104.0	18.25	10.45	20.62	11.92	21.74	13.72	23.28	15.42	24.88	16.86	25.65	19.32
115.0	17.21	9.30	19.45	10.60	20.50	12.21	21.95	13.71	23.47	15.00	24.19	17.18

● Cooling capacity in kW

- TC: Total Capacity (kW), SHC: Sensible Heat Capacity (kW).
- The data is based on the following conditions:
Pipe length: 24.6 ft (7.5 m), Height difference: 0 ft (0 m) [Outdoor unit - Indoor unit]

MODEL: ARU7RLF

Outdoor temperature (°CDB)	Indoor temperature (°CDB / °CWB)											
	17.8 / 12.2		21.1 / 15.6		23.9 / 17.2		26.7 / 19.4		29.4 / 21.7		32.2 / 22.8	
	TC	SHC	TC	SHC	TC	SHC	TC	SHC	TC	SHC	TC	SHC
-10.0	1.75	1.21	1.97	1.38	2.08	1.59	2.23	1.78	2.38	1.95	2.45	2.23
-5.0	1.75	1.21	1.97	1.38	2.08	1.59	2.23	1.78	2.38	1.95	2.45	2.23
0.0	1.75	1.21	1.97	1.38	2.08	1.59	2.23	1.78	2.38	1.95	2.45	2.23
5.0	1.75	1.21	1.97	1.38	2.08	1.59	2.23	1.78	2.38	1.95	2.45	2.23
10.0	1.75	1.21	1.97	1.38	2.08	1.59	2.23	1.78	2.38	1.95	2.45	2.23
15.0	1.75	1.21	1.97	1.38	2.08	1.59	2.23	1.78	2.38	1.95	2.45	2.23
20.0	1.75	1.21	1.97	1.38	2.08	1.59	2.23	1.78	2.38	1.95	2.45	2.23
25.0	1.75	1.21	1.97	1.38	2.08	1.59	2.23	1.78	2.38	1.95	2.45	2.23
30.0	1.75	1.21	1.97	1.38	2.08	1.59	2.23	1.78	2.38	1.95	2.45	2.23
35.0	1.75	1.21	1.97	1.38	2.08	1.59	2.23	1.78	2.38	1.95	2.45	2.23
40.0	1.65	1.08	1.87	1.23	1.97	1.42	2.11	1.60	2.25	1.74	2.32	2.00
46.1	1.56	0.96	1.76	1.10	1.86	1.26	1.99	1.42	2.12	1.55	2.19	1.78

MODEL: ARU9RLF

Outdoor temperature (°CDB)	Indoor temperature (°CDB / °CWB)											
	17.8 / 12.2		21.1 / 15.6		23.9 / 17.2		26.7 / 19.4		29.4 / 21.7		32.2 / 22.8	
	TC	SHC	TC	SHC	TC	SHC	TC	SHC	TC	SHC	TC	SHC
-10.0	2.25	1.44	2.54	1.64	2.68	1.89	2.87	2.13	3.07	2.32	3.17	2.66
-5.0	2.25	1.44	2.54	1.64	2.68	1.89	2.87	2.13	3.07	2.32	3.17	2.66
0.0	2.25	1.44	2.54	1.64	2.68	1.89	2.87	2.13	3.07	2.32	3.17	2.66
5.0	2.25	1.44	2.54	1.64	2.68	1.89	2.87	2.13	3.07	2.32	3.17	2.66
10.0	2.25	1.44	2.54	1.64	2.68	1.89	2.87	2.13	3.07	2.32	3.17	2.66
15.0	2.25	1.44	2.54	1.64	2.68	1.89	2.87	2.13	3.07	2.32	3.17	2.66
20.0	2.25	1.44	2.54	1.64	2.68	1.89	2.87	2.13	3.07	2.32	3.17	2.66
25.0	2.25	1.44	2.54	1.64	2.68	1.89	2.87	2.13	3.07	2.32	3.17	2.66
30.0	2.25	1.44	2.54	1.64	2.68	1.89	2.87	2.13	3.07	2.32	3.17	2.66
35.0	2.25	1.44	2.54	1.64	2.68	1.89	2.87	2.13	3.07	2.32	3.17	2.66
40.0	2.13	1.29	2.41	1.47	2.54	1.69	2.72	1.90	2.91	2.08	2.99	2.38
46.1	2.01	1.15	2.27	1.31	2.39	1.51	2.56	1.69	2.74	1.85	2.82	2.12

MODEL: ARU12RLF

Outdoor temperature (°CDB)	Indoor temperature (°CDB / °CWB)											
	17.8 / 12.2		21.1 / 15.6		23.9 / 17.2		26.7 / 19.4		29.4 / 21.7		32.2 / 22.8	
	TC	SHC	TC	SHC	TC	SHC	TC	SHC	TC	SHC	TC	SHC
-10.0	2.99	1.91	3.38	2.18	3.56	2.51	3.81	2.82	4.07	3.08	4.20	3.53
-5.0	2.99	1.91	3.38	2.18	3.56	2.51	3.81	2.82	4.07	3.08	4.20	3.53
0.0	2.99	1.91	3.38	2.18	3.56	2.51	3.81	2.82	4.07	3.08	4.20	3.53
5.0	2.99	1.91	3.38	2.18	3.56	2.51	3.81	2.82	4.07	3.08	4.20	3.53
10.0	2.99	1.91	3.38	2.18	3.56	2.51	3.81	2.82	4.07	3.08	4.20	3.53
15.0	2.99	1.91	3.38	2.18	3.56	2.51	3.81	2.82	4.07	3.08	4.20	3.53
20.0	2.99	1.91	3.38	2.18	3.56	2.51	3.81	2.82	4.07	3.08	4.20	3.53
25.0	2.99	1.91	3.38	2.18	3.56	2.51	3.81	2.82	4.07	3.08	4.20	3.53
30.0	2.99	1.91	3.38	2.18	3.56	2.51	3.81	2.82	4.07	3.08	4.20	3.53
35.0	2.99	1.91	3.38	2.18	3.56	2.51	3.81	2.82	4.07	3.08	4.20	3.53
40.0	2.83	1.71	3.19	1.95	3.37	2.25	3.61	2.52	3.85	2.76	3.97	3.16
46.1	2.67	1.52	3.01	1.74	3.18	2.00	3.40	2.25	3.63	2.46	3.75	2.81

MODEL: ARU18RLF

Outdoor temperature (°CDB)	Indoor temperature (°CDB / °CWB)											
	17.8 / 12.2		21.1 / 15.6		23.9 / 17.2		26.7 / 19.4		29.4 / 21.7		32.2 / 22.8	
	TC	SHC	TC	SHC	TC	SHC	TC	SHC	TC	SHC	TC	SHC
-10.0	4.48	2.79	5.06	3.18	5.34	3.66	5.72	4.11	6.11	4.50	6.30	5.16
-5.0	4.48	2.79	5.06	3.18	5.34	3.66	5.72	4.11	6.11	4.50	6.30	5.16
0.0	4.48	2.79	5.06	3.18	5.34	3.66	5.72	4.11	6.11	4.50	6.30	5.16
5.0	4.48	2.79	5.06	3.18	5.34	3.66	5.72	4.11	6.11	4.50	6.30	5.16
10.0	4.48	2.79	5.06	3.18	5.34	3.66	5.72	4.11	6.11	4.50	6.30	5.16
15.0	4.48	2.79	5.06	3.18	5.34	3.66	5.72	4.11	6.11	4.50	6.30	5.16
20.0	4.48	2.79	5.06	3.18	5.34	3.66	5.72	4.11	6.11	4.50	6.30	5.16
25.0	4.48	2.79	5.06	3.18	5.34	3.66	5.72	4.11	6.11	4.50	6.30	5.16
30.0	4.48	2.79	5.06	3.18	5.34	3.66	5.72	4.11	6.11	4.50	6.30	5.16
35.0	4.48	2.79	5.06	3.18	5.34	3.66	5.72	4.11	6.11	4.50	6.30	5.16
40.0	4.24	2.50	4.79	2.85	5.05	3.28	5.41	3.68	5.78	4.03	5.96	4.62
46.1	4.00	2.22	4.52	2.53	4.76	2.92	5.10	3.28	5.45	3.58	5.62	4.11

OUTDOOR UNIT
AOJ36RLXFZH

MODEL: ARU24RLF

Outdoor temperature (°CDB)	Indoor temperature (°CDB / °CWB)											
	17.8 / 12.2		21.1 / 15.6		23.9 / 17.2		26.7 / 19.4		29.4 / 21.7		32.2 / 22.8	
	TC	SHC	TC	SHC	TC	SHC	TC	SHC	TC	SHC	TC	SHC
-10.0	5.65	3.42	6.39	3.90	6.73	4.49	7.21	5.05	7.71	5.52	7.95	6.32
-5.0	5.65	3.42	6.39	3.90	6.73	4.49	7.21	5.05	7.71	5.52	7.95	6.32
0.0	5.65	3.42	6.39	3.90	6.73	4.49	7.21	5.05	7.71	5.52	7.95	6.32
5.0	5.65	3.42	6.39	3.90	6.73	4.49	7.21	5.05	7.71	5.52	7.95	6.32
10.0	5.65	3.42	6.39	3.90	6.73	4.49	7.21	5.05	7.71	5.52	7.95	6.32
15.0	5.65	3.42	6.39	3.90	6.73	4.49	7.21	5.05	7.71	5.52	7.95	6.32
20.0	5.65	3.42	6.39	3.90	6.73	4.49	7.21	5.05	7.71	5.52	7.95	6.32
25.0	5.65	3.42	6.39	3.90	6.73	4.49	7.21	5.05	7.71	5.52	7.95	6.32
30.0	5.65	3.42	6.39	3.90	6.73	4.49	7.21	5.05	7.71	5.52	7.95	6.32
35.0	5.65	3.42	6.39	3.90	6.73	4.49	7.21	5.05	7.71	5.52	7.95	6.32
40.0	5.35	3.06	6.04	3.49	6.37	4.02	6.82	4.52	7.29	4.94	7.52	5.66
46.1	5.04	2.73	5.70	3.11	6.01	3.58	6.43	4.02	6.88	4.40	7.09	5.04

■ Wall mounted type

● Cooling capacity in kBtu/h

- TC: Total Capacity (kBtu/h), SHC: Sensible Heat Capacity (kBtu/h).
- The data is based on the following conditions:
Pipe length: 24.6 ft (7.5 m), Height difference: 0 ft (0 m) [Outdoor unit - Indoor unit]

MODEL: ASU7RLF1

Outdoor temperature (°FDB)	Indoor temperature (°FDB / °FWB)											
	64.0 / 54.0		70.0 / 60.0		75.0 / 63.0		80.0 / 67.0		85.0 / 71.0		90.0 / 73.0	
	TC	SHC	TC	SHC	TC	SHC	TC	SHC	TC	SHC	TC	SHC
14.0	5.96	4.17	6.73	4.76	7.10	5.48	7.60	6.16	8.12	6.73	8.38	7.71
23.0	5.96	4.17	6.73	4.76	7.10	5.48	7.60	6.16	8.12	6.73	8.38	7.71
32.0	5.96	4.17	6.73	4.76	7.10	5.48	7.60	6.16	8.12	6.73	8.38	7.71
41.0	5.96	4.17	6.73	4.76	7.10	5.48	7.60	6.16	8.12	6.73	8.38	7.71
50.0	5.96	4.17	6.73	4.76	7.10	5.48	7.60	6.16	8.12	6.73	8.38	7.71
59.0	5.96	4.17	6.73	4.76	7.10	5.48	7.60	6.16	8.12	6.73	8.38	7.71
67.0	5.96	4.17	6.73	4.76	7.10	5.48	7.60	6.16	8.12	6.73	8.38	7.71
77.0	5.96	4.17	6.73	4.76	7.10	5.48	7.60	6.16	8.12	6.73	8.38	7.71
87.0	5.96	4.17	6.73	4.76	7.10	5.48	7.60	6.16	8.12	6.73	8.38	7.71
95.0	5.96	4.17	6.73	4.76	7.10	5.48	7.60	6.16	8.12	6.73	8.38	7.71
104.0	5.18	3.16	5.86	3.60	6.17	4.15	6.61	4.66	7.07	5.09	7.29	5.84
115.0	4.41	2.28	4.98	2.60	5.25	3.00	5.62	3.37	6.01	3.68	6.20	4.22

MODEL: ASU9RLF1

Outdoor temperature (°FDB)	Indoor temperature (°FDB / °FWB)											
	64.0 / 54.0		70.0 / 60.0		75.0 / 63.0		80.0 / 67.0		85.0 / 71.0		90.0 / 73.0	
	TC	SHC	TC	SHC	TC	SHC	TC	SHC	TC	SHC	TC	SHC
14.0	7.68	5.38	8.68	6.14	9.15	7.07	9.80	7.94	10.48	8.68	10.80	9.95
23.0	7.68	5.38	8.68	6.14	9.15	7.07	9.80	7.94	10.48	8.68	10.80	9.95
32.0	7.68	5.38	8.68	6.14	9.15	7.07	9.80	7.94	10.48	8.68	10.80	9.95
41.0	7.68	5.38	8.68	6.14	9.15	7.07	9.80	7.94	10.48	8.68	10.80	9.95
50.0	7.68	5.38	8.68	6.14	9.15	7.07	9.80	7.94	10.48	8.68	10.80	9.95
59.0	7.68	5.38	8.68	6.14	9.15	7.07	9.80	7.94	10.48	8.68	10.80	9.95
67.0	7.68	5.38	8.68	6.14	9.15	7.07	9.80	7.94	10.48	8.68	10.80	9.95
77.0	7.68	5.38	8.68	6.14	9.15	7.07	9.80	7.94	10.48	8.68	10.80	9.95
87.0	7.68	5.38	8.68	6.14	9.15	7.07	9.80	7.94	10.48	8.68	10.80	9.95
95.0	7.68	5.38	8.68	6.14	9.15	7.07	9.80	7.94	10.48	8.68	10.80	9.95
104.0	6.68	4.07	7.55	4.64	7.96	5.35	8.52	6.01	9.11	6.57	9.39	7.53
115.0	5.68	2.95	6.42	3.36	6.77	3.87	7.25	4.34	7.75	4.75	7.99	5.44

MODEL: ASU12RLF1

Outdoor temperature (°FDB)	Indoor temperature (°FDB / °FWB)											
	64.0 / 54.0		70.0 / 60.0		75.0 / 63.0		80.0 / 67.0		85.0 / 71.0		90.0 / 73.0	
	TC	SHC	TC	SHC	TC	SHC	TC	SHC	TC	SHC	TC	SHC
14.0	10.19	6.70	11.52	7.64	12.14	8.79	13.00	9.88	13.90	10.81	14.33	12.38
23.0	10.19	6.70	11.52	7.64	12.14	8.79	13.00	9.88	13.90	10.81	14.33	12.38
32.0	10.19	6.70	11.52	7.64	12.14	8.79	13.00	9.88	13.90	10.81	14.33	12.38
41.0	10.19	6.70	11.52	7.64	12.14	8.79	13.00	9.88	13.90	10.81	14.33	12.38
50.0	10.19	6.70	11.52	7.64	12.14	8.79	13.00	9.88	13.90	10.81	14.33	12.38
59.0	10.19	6.70	11.52	7.64	12.14	8.79	13.00	9.88	13.90	10.81	14.33	12.38
67.0	10.19	6.70	11.52	7.64	12.14	8.79	13.00	9.88	13.90	10.81	14.33	12.38
77.0	10.19	6.70	11.52	7.64	12.14	8.79	13.00	9.88	13.90	10.81	14.33	12.38
87.0	10.19	6.70	11.52	7.64	12.14	8.79	13.00	9.88	13.90	10.81	14.33	12.38
95.0	10.19	6.70	11.52	7.64	12.14	8.79	13.00	9.88	13.90	10.81	14.33	12.38
104.0	8.87	5.07	10.02	5.78	10.56	6.65	11.31	7.48	12.09	8.18	12.46	9.37
115.0	7.54	3.67	8.52	4.18	8.98	4.81	9.62	5.41	10.28	5.91	10.60	6.77

MODEL: ASU15RLF1

Outdoor temperature (°FDB)	Indoor temperature (°FDB / °FWB)											
	64.0 / 54.0		70.0 / 60.0		75.0 / 63.0		80.0 / 67.0		85.0 / 71.0		90.0 / 73.0	
	TC	SHC	TC	SHC	TC	SHC	TC	SHC	TC	SHC	TC	SHC
14.0	12.78	8.29	14.44	9.45	15.22	10.88	16.30	12.23	17.42	13.37	17.96	15.32
23.0	12.78	8.29	14.44	9.45	15.22	10.88	16.30	12.23	17.42	13.37	17.96	15.32
32.0	12.78	8.29	14.44	9.45	15.22	10.88	16.30	12.23	17.42	13.37	17.96	15.32
41.0	12.78	8.29	14.44	9.45	15.22	10.88	16.30	12.23	17.42	13.37	17.96	15.32
50.0	12.78	8.29	14.44	9.45	15.22	10.88	16.30	12.23	17.42	13.37	17.96	15.32
59.0	12.78	8.29	14.44	9.45	15.22	10.88	16.30	12.23	17.42	13.37	17.96	15.32
67.0	12.78	8.29	14.44	9.45	15.22	10.88	16.30	12.23	17.42	13.37	17.96	15.32
77.0	12.78	8.29	14.44	9.45	15.22	10.88	16.30	12.23	17.42	13.37	17.96	15.32
87.0	12.78	8.29	14.44	9.45	15.22	10.88	16.30	12.23	17.42	13.37	17.96	15.32
95.0	12.78	8.29	14.44	9.45	15.22	10.88	16.30	12.23	17.42	13.37	17.96	15.32
104.0	11.12	6.27	12.56	7.15	13.24	8.23	14.18	9.25	15.16	10.12	15.63	11.59
115.0	9.45	4.54	10.68	5.17	11.26	5.95	12.06	6.69	12.89	7.32	13.29	8.38

OUTDOOR UNIT
AOJ36RLXZFH

MODEL: ASU18RLF

Outdoor temperature (°FDB)	Indoor temperature (°FDB / °FWB)											
	64.0 / 54.0		70.0 / 60.0		75.0 / 63.0		80.0 / 67.0		85.0 / 71.0		90.0 / 73.0	
	TC	SHC	TC	SHC	TC	SHC	TC	SHC	TC	SHC	TC	SHC
14.0	15.29	10.18	17.28	11.61	18.21	13.36	19.50	15.02	20.85	16.42	21.49	18.82
23.0	15.29	10.18	17.28	11.61	18.21	13.36	19.50	15.02	20.85	16.42	21.49	18.82
32.0	15.29	10.18	17.28	11.61	18.21	13.36	19.50	15.02	20.85	16.42	21.49	18.82
41.0	15.29	10.18	17.28	11.61	18.21	13.36	19.50	15.02	20.85	16.42	21.49	18.82
50.0	15.29	10.18	17.28	11.61	18.21	13.36	19.50	15.02	20.85	16.42	21.49	18.82
59.0	15.29	10.18	17.28	11.61	18.21	13.36	19.50	15.02	20.85	16.42	21.49	18.82
67.0	15.29	10.18	17.28	11.61	18.21	13.36	19.50	15.02	20.85	16.42	21.49	18.82
77.0	15.29	10.18	17.28	11.61	18.21	13.36	19.50	15.02	20.85	16.42	21.49	18.82
87.0	15.29	10.18	17.28	11.61	18.21	13.36	19.50	15.02	20.85	16.42	21.49	18.82
95.0	15.29	10.18	17.28	11.61	18.21	13.36	19.50	15.02	20.85	16.42	21.49	18.82
104.0	13.30	7.70	15.03	8.78	15.84	10.11	16.96	11.36	18.13	12.43	18.69	14.24
115.0	11.31	5.57	12.78	6.35	13.47	7.31	14.42	8.22	15.42	8.99	15.90	10.30

MODEL: ASU24RLF

Outdoor temperature (°FDB)	Indoor temperature (°FDB / °FWB)											
	64.0 / 54.0		70.0 / 60.0		75.0 / 63.0		80.0 / 67.0		85.0 / 71.0		90.0 / 73.0	
	TC	SHC	TC	SHC	TC	SHC	TC	SHC	TC	SHC	TC	SHC
14.0	19.29	11.68	21.80	13.31	22.98	15.33	24.60	17.22	26.30	18.83	27.11	21.58
23.0	19.29	11.68	21.80	13.31	22.98	15.33	24.60	17.22	26.30	18.83	27.11	21.58
32.0	19.29	11.68	21.80	13.31	22.98	15.33	24.60	17.22	26.30	18.83	27.11	21.58
41.0	19.29	11.68	21.80	13.31	22.98	15.33	24.60	17.22	26.30	18.83	27.11	21.58
50.0	19.29	11.68	21.80	13.31	22.98	15.33	24.60	17.22	26.30	18.83	27.11	21.58
59.0	19.29	11.68	21.80	13.31	22.98	15.33	24.60	17.22	26.30	18.83	27.11	21.58
67.0	19.29	11.68	21.80	13.31	22.98	15.33	24.60	17.22	26.30	18.83	27.11	21.58
77.0	19.29	11.68	21.80	13.31	22.98	15.33	24.60	17.22	26.30	18.83	27.11	21.58
87.0	19.29	11.68	21.80	13.31	22.98	15.33	24.60	17.22	26.30	18.83	27.11	21.58
95.0	19.29	11.68	21.80	13.31	22.98	15.33	24.60	17.22	26.30	18.83	27.11	21.58
104.0	16.78	8.84	18.96	10.07	19.99	11.60	21.40	13.03	22.88	14.25	23.58	16.33
115.0	14.27	6.39	16.12	7.28	17.00	8.39	18.20	9.42	19.45	10.31	20.05	11.81

● Cooling capacity in kW

- TC: Total Capacity (kW), SHC: Sensible Heat Capacity (kW).
- The data is based on the following conditions:
Pipe length: 24.6 ft (7.5 m), Height difference: 0 ft (0 m) [Outdoor unit - Indoor unit]

MODEL: ASU7RLF1

Outdoor temperature (°CDB)	Indoor temperature (°CDB / °CWB)											
	17.8 / 12.2		21.1 / 15.6		23.9 / 17.2		26.7 / 19.4		29.4 / 21.7		32.2 / 22.8	
	TC	SHC	TC	SHC	TC	SHC	TC	SHC	TC	SHC	TC	SHC
-10.0	1.75	1.22	1.97	1.39	2.08	1.61	2.23	1.80	2.38	1.97	2.45	2.26
-5.0	1.75	1.22	1.97	1.39	2.08	1.61	2.23	1.80	2.38	1.97	2.45	2.26
0.0	1.75	1.22	1.97	1.39	2.08	1.61	2.23	1.80	2.38	1.97	2.45	2.26
5.0	1.75	1.22	1.97	1.39	2.08	1.61	2.23	1.80	2.38	1.97	2.45	2.26
10.0	1.75	1.22	1.97	1.39	2.08	1.61	2.23	1.80	2.38	1.97	2.45	2.26
15.0	1.75	1.22	1.97	1.39	2.08	1.61	2.23	1.80	2.38	1.97	2.45	2.26
20.0	1.75	1.22	1.97	1.39	2.08	1.61	2.23	1.80	2.38	1.97	2.45	2.26
25.0	1.75	1.22	1.97	1.39	2.08	1.61	2.23	1.80	2.38	1.97	2.45	2.26
30.0	1.75	1.22	1.97	1.39	2.08	1.61	2.23	1.80	2.38	1.97	2.45	2.26
35.0	1.75	1.22	1.97	1.39	2.08	1.61	2.23	1.80	2.38	1.97	2.45	2.26
40.0	1.52	0.93	1.72	1.06	1.81	1.22	1.94	1.37	2.07	1.49	2.14	1.71
46.1	1.29	0.67	1.46	0.76	1.54	0.88	1.65	0.99	1.76	1.08	1.82	1.24

MODEL: ASU9RLF1

Outdoor temperature (°CDB)	Indoor temperature (°CDB / °CWB)											
	17.8 / 12.2		21.1 / 15.6		23.9 / 17.2		26.7 / 19.4		29.4 / 21.7		32.2 / 22.8	
	TC	SHC	TC	SHC	TC	SHC	TC	SHC	TC	SHC	TC	SHC
-10.0	2.25	1.58	2.54	1.80	2.68	2.07	2.87	2.33	3.07	2.54	3.17	2.92
-5.0	2.25	1.58	2.54	1.80	2.68	2.07	2.87	2.33	3.07	2.54	3.17	2.92
0.0	2.25	1.58	2.54	1.80	2.68	2.07	2.87	2.33	3.07	2.54	3.17	2.92
5.0	2.25	1.58	2.54	1.80	2.68	2.07	2.87	2.33	3.07	2.54	3.17	2.92
10.0	2.25	1.58	2.54	1.80	2.68	2.07	2.87	2.33	3.07	2.54	3.17	2.92
15.0	2.25	1.58	2.54	1.80	2.68	2.07	2.87	2.33	3.07	2.54	3.17	2.92
20.0	2.25	1.58	2.54	1.80	2.68	2.07	2.87	2.33	3.07	2.54	3.17	2.92
25.0	2.25	1.58	2.54	1.80	2.68	2.07	2.87	2.33	3.07	2.54	3.17	2.92
30.0	2.25	1.58	2.54	1.80	2.68	2.07	2.87	2.33	3.07	2.54	3.17	2.92
35.0	2.25	1.58	2.54	1.80	2.68	2.07	2.87	2.33	3.07	2.54	3.17	2.92
40.0	1.96	1.19	2.21	1.36	2.33	1.57	2.50	1.76	2.67	1.93	2.75	2.21
46.1	1.67	0.86	1.88	0.98	1.98	1.13	2.12	1.27	2.27	1.39	2.34	1.60

MODEL: ASU12RLF1

Outdoor temperature (°CDB)	Indoor temperature (°CDB / °CWB)											
	17.8 / 12.2		21.1 / 15.6		23.9 / 17.2		26.7 / 19.4		29.4 / 21.7		32.2 / 22.8	
	TC	SHC	TC	SHC	TC	SHC	TC	SHC	TC	SHC	TC	SHC
-10.0	2.99	1.96	3.38	2.24	3.56	2.58	3.81	2.90	4.07	3.17	4.20	3.63
-5.0	2.99	1.96	3.38	2.24	3.56	2.58	3.81	2.90	4.07	3.17	4.20	3.63
0.0	2.99	1.96	3.38	2.24	3.56	2.58	3.81	2.90	4.07	3.17	4.20	3.63
5.0	2.99	1.96	3.38	2.24	3.56	2.58	3.81	2.90	4.07	3.17	4.20	3.63
10.0	2.99	1.96	3.38	2.24	3.56	2.58	3.81	2.90	4.07	3.17	4.20	3.63
15.0	2.99	1.96	3.38	2.24	3.56	2.58	3.81	2.90	4.07	3.17	4.20	3.63
20.0	2.99	1.96	3.38	2.24	3.56	2.58	3.81	2.90	4.07	3.17	4.20	3.63
25.0	2.99	1.96	3.38	2.24	3.56	2.58	3.81	2.90	4.07	3.17	4.20	3.63
30.0	2.99	1.96	3.38	2.24	3.56	2.58	3.81	2.90	4.07	3.17	4.20	3.63
35.0	2.99	1.96	3.38	2.24	3.56	2.58	3.81	2.90	4.07	3.17	4.20	3.63
40.0	2.60	1.49	2.94	1.69	3.10	1.95	3.31	2.19	3.54	2.40	3.65	2.75
46.1	2.21	1.07	2.50	1.22	2.63	1.41	2.82	1.58	3.01	1.73	3.11	1.99

MODEL: ASU15RLF1

Outdoor temperature (°CDB)	Indoor temperature (°CDB / °CWB)											
	17.8 / 12.2		21.1 / 15.6		23.9 / 17.2		26.7 / 19.4		29.4 / 21.7		32.2 / 22.8	
	TC	SHC	TC	SHC	TC	SHC	TC	SHC	TC	SHC	TC	SHC
-10.0	3.75	2.43	4.23	2.77	4.46	3.19	4.78	3.58	5.11	3.92	5.26	4.49
-5.0	3.75	2.43	4.23	2.77	4.46	3.19	4.78	3.58	5.11	3.92	5.26	4.49
0.0	3.75	2.43	4.23	2.77	4.46	3.19	4.78	3.58	5.11	3.92	5.26	4.49
5.0	3.75	2.43	4.23	2.77	4.46	3.19	4.78	3.58	5.11	3.92	5.26	4.49
10.0	3.75	2.43	4.23	2.77	4.46	3.19	4.78	3.58	5.11	3.92	5.26	4.49
15.0	3.75	2.43	4.23	2.77	4.46	3.19	4.78	3.58	5.11	3.92	5.26	4.49
20.0	3.75	2.43	4.23	2.77	4.46	3.19	4.78	3.58	5.11	3.92	5.26	4.49
25.0	3.75	2.43	4.23	2.77	4.46	3.19	4.78	3.58	5.11	3.92	5.26	4.49
30.0	3.75	2.43	4.23	2.77	4.46	3.19	4.78	3.58	5.11	3.92	5.26	4.49
35.0	3.75	2.43	4.23	2.77	4.46	3.19	4.78	3.58	5.11	3.92	5.26	4.49
40.0	3.26	1.84	3.68	2.10	3.88	2.41	4.16	2.71	4.44	2.97	4.58	3.40
46.1	2.77	1.33	3.13	1.52	3.30	1.75	3.53	1.96	3.78	2.14	3.89	2.46

OUTDOOR UNIT
AOJ36RLXFZH

MODEL: ASU18RLF

Outdoor temperature (°CDB)	Indoor temperature (°CDB / °CWB)											
	17.8 / 12.2		21.1 / 15.6		23.9 / 17.2		26.7 / 19.4		29.4 / 21.7		32.2 / 22.8	
	TC	SHC	TC	SHC	TC	SHC	TC	SHC	TC	SHC	TC	SHC
-10.0	4.48	2.98	5.06	3.40	5.34	3.92	5.72	4.40	6.11	4.81	6.30	5.51
-5.0	4.48	2.98	5.06	3.40	5.34	3.92	5.72	4.40	6.11	4.81	6.30	5.51
0.0	4.48	2.98	5.06	3.40	5.34	3.92	5.72	4.40	6.11	4.81	6.30	5.51
5.0	4.48	2.98	5.06	3.40	5.34	3.92	5.72	4.40	6.11	4.81	6.30	5.51
10.0	4.48	2.98	5.06	3.40	5.34	3.92	5.72	4.40	6.11	4.81	6.30	5.51
15.0	4.48	2.98	5.06	3.40	5.34	3.92	5.72	4.40	6.11	4.81	6.30	5.51
20.0	4.48	2.98	5.06	3.40	5.34	3.92	5.72	4.40	6.11	4.81	6.30	5.51
25.0	4.48	2.98	5.06	3.40	5.34	3.92	5.72	4.40	6.11	4.81	6.30	5.51
30.0	4.48	2.98	5.06	3.40	5.34	3.92	5.72	4.40	6.11	4.81	6.30	5.51
35.0	4.48	2.98	5.06	3.40	5.34	3.92	5.72	4.40	6.11	4.81	6.30	5.51
40.0	3.90	2.26	4.40	2.57	4.64	2.96	4.97	3.33	5.31	3.64	5.48	4.17
46.1	3.31	1.63	3.75	1.86	3.95	2.14	4.23	2.41	4.52	2.63	4.66	3.02

MODEL: ASU24RLF

Outdoor temperature (°CDB)	Indoor temperature (°CDB / °CWB)											
	17.8 / 12.2		21.1 / 15.6		23.9 / 17.2		26.7 / 19.4		29.4 / 21.7		32.2 / 22.8	
	TC	SHC	TC	SHC	TC	SHC	TC	SHC	TC	SHC	TC	SHC
-10.0	5.65	3.42	6.39	3.90	6.73	4.49	7.21	5.05	7.71	5.52	7.95	6.32
-5.0	5.65	3.42	6.39	3.90	6.73	4.49	7.21	5.05	7.71	5.52	7.95	6.32
0.0	5.65	3.42	6.39	3.90	6.73	4.49	7.21	5.05	7.71	5.52	7.95	6.32
5.0	5.65	3.42	6.39	3.90	6.73	4.49	7.21	5.05	7.71	5.52	7.95	6.32
10.0	5.65	3.42	6.39	3.90	6.73	4.49	7.21	5.05	7.71	5.52	7.95	6.32
15.0	5.65	3.42	6.39	3.90	6.73	4.49	7.21	5.05	7.71	5.52	7.95	6.32
20.0	5.65	3.42	6.39	3.90	6.73	4.49	7.21	5.05	7.71	5.52	7.95	6.32
25.0	5.65	3.42	6.39	3.90	6.73	4.49	7.21	5.05	7.71	5.52	7.95	6.32
30.0	5.65	3.42	6.39	3.90	6.73	4.49	7.21	5.05	7.71	5.52	7.95	6.32
35.0	5.65	3.42	6.39	3.90	6.73	4.49	7.21	5.05	7.71	5.52	7.95	6.32
40.0	4.92	2.59	5.56	2.95	5.86	3.40	6.27	3.82	6.70	4.18	6.91	4.79
46.1	4.18	1.87	4.73	2.14	4.98	2.46	5.33	2.76	5.70	3.02	5.88	3.46

■ Floor type

● Cooling capacity in kBtu/h

- TC: Total Capacity (kBtu/h), SHC: Sensible Heat Capacity (kBtu/h).
- The data is based on the following conditions:
Pipe length: 24.6 ft (7.5 m), Height difference: 0 ft (0 m) [Outdoor unit - Indoor unit]

MODEL: AGU9RLF

Outdoor temperature	Indoor temperature (°FDB / °FWB)											
	64.0 / 54.0		70.0 / 60.0		75.0 / 63.0		80.0 / 67.0		85.0 / 71.0		90.0 / 73.0	
(°FDB)	TC	SHC	TC	SHC	TC	SHC	TC	SHC	TC	SHC	TC	SHC
14.0	7.68	5.25	8.68	5.99	9.15	6.89	9.80	7.74	10.48	8.47	10.80	9.70
23.0	7.68	5.25	8.68	5.99	9.15	6.89	9.80	7.74	10.48	8.47	10.80	9.70
32.0	7.68	5.25	8.68	5.99	9.15	6.89	9.80	7.74	10.48	8.47	10.80	9.70
41.0	7.68	5.25	8.68	5.99	9.15	6.89	9.80	7.74	10.48	8.47	10.80	9.70
50.0	7.68	5.25	8.68	5.99	9.15	6.89	9.80	7.74	10.48	8.47	10.80	9.70
59.0	7.68	5.25	8.68	5.99	9.15	6.89	9.80	7.74	10.48	8.47	10.80	9.70
67.0	7.68	5.25	8.68	5.99	9.15	6.89	9.80	7.74	10.48	8.47	10.80	9.70
77.0	7.68	5.25	8.68	5.99	9.15	6.89	9.80	7.74	10.48	8.47	10.80	9.70
87.0	7.68	5.25	8.68	5.99	9.15	6.89	9.80	7.74	10.48	8.47	10.80	9.70
95.0	7.68	5.25	8.68	5.99	9.15	6.89	9.80	7.74	10.48	8.47	10.80	9.70
104.0	7.27	4.70	8.22	5.36	8.66	6.17	9.27	6.93	9.91	7.58	10.22	8.69
115.0	6.86	4.18	7.75	4.77	8.17	5.49	8.75	6.17	9.35	6.74	9.64	7.73

MODEL: AGU12RLF

Outdoor temperature	Indoor temperature (°FDB / °FWB)											
	64.0 / 54.0		70.0 / 60.0		75.0 / 63.0		80.0 / 67.0		85.0 / 71.0		90.0 / 73.0	
(°FDB)	TC	SHC	TC	SHC	TC	SHC	TC	SHC	TC	SHC	TC	SHC
14.0	10.19	6.52	11.52	7.44	12.14	8.56	13.00	9.62	13.90	10.52	14.33	12.05
23.0	10.19	6.52	11.52	7.44	12.14	8.56	13.00	9.62	13.90	10.52	14.33	12.05
32.0	10.19	6.52	11.52	7.44	12.14	8.56	13.00	9.62	13.90	10.52	14.33	12.05
41.0	10.19	6.52	11.52	7.44	12.14	8.56	13.00	9.62	13.90	10.52	14.33	12.05
50.0	10.19	6.52	11.52	7.44	12.14	8.56	13.00	9.62	13.90	10.52	14.33	12.05
59.0	10.19	6.52	11.52	7.44	12.14	8.56	13.00	9.62	13.90	10.52	14.33	12.05
67.0	10.19	6.52	11.52	7.44	12.14	8.56	13.00	9.62	13.90	10.52	14.33	12.05
77.0	10.19	6.52	11.52	7.44	12.14	8.56	13.00	9.62	13.90	10.52	14.33	12.05
87.0	10.19	6.52	11.52	7.44	12.14	8.56	13.00	9.62	13.90	10.52	14.33	12.05
95.0	10.19	6.52	11.52	7.44	12.14	8.56	13.00	9.62	13.90	10.52	14.33	12.05
104.0	9.64	5.84	10.90	6.66	11.49	7.67	12.30	8.61	13.15	9.42	13.56	10.79
115.0	9.10	5.20	10.28	5.92	10.84	6.82	11.60	7.66	12.40	8.38	12.78	9.60

MODEL: AGU15RLF

Outdoor temperature	Indoor temperature (°FDB / °FWB)											
	64.0 / 54.0		70.0 / 60.0		75.0 / 63.0		80.0 / 67.0		85.0 / 71.0		90.0 / 73.0	
(°FDB)	TC	SHC	TC	SHC	TC	SHC	TC	SHC	TC	SHC	TC	SHC
14.0	12.78	7.96	14.44	9.07	15.22	10.45	16.30	11.74	17.42	12.84	17.96	14.71
23.0	12.78	7.96	14.44	9.07	15.22	10.45	16.30	11.74	17.42	12.84	17.96	14.71
32.0	12.78	7.96	14.44	9.07	15.22	10.45	16.30	11.74	17.42	12.84	17.96	14.71
41.0	12.78	7.96	14.44	9.07	15.22	10.45	16.30	11.74	17.42	12.84	17.96	14.71
50.0	12.78	7.96	14.44	9.07	15.22	10.45	16.30	11.74	17.42	12.84	17.96	14.71
59.0	12.78	7.96	14.44	9.07	15.22	10.45	16.30	11.74	17.42	12.84	17.96	14.71
67.0	12.78	7.96	14.44	9.07	15.22	10.45	16.30	11.74	17.42	12.84	17.96	14.71
77.0	12.78	7.96	14.44	9.07	15.22	10.45	16.30	11.74	17.42	12.84	17.96	14.71
87.0	12.78	7.96	14.44	9.07	15.22	10.45	16.30	11.74	17.42	12.84	17.96	14.71
95.0	12.78	7.96	14.44	9.07	15.22	10.45	16.30	11.74	17.42	12.84	17.96	14.71
104.0	12.09	7.13	13.66	8.12	14.40	9.35	15.42	10.51	16.49	11.49	17.00	13.17
115.0	11.40	6.34	12.89	7.22	13.59	8.32	14.55	9.35	15.55	10.22	16.03	11.71

● Cooling capacity in kW

- TC: Total Capacity (kW), SHC: Sensible Heat Capacity (kW).
- The data is based on the following conditions:
Pipe length: 24.6 ft (7.5 m), Height difference: 0 ft (0 m) [Outdoor unit - Indoor unit]

MODEL: AGU9RLF

Outdoor temperature (°CDB)	Indoor temperature (°CDB / °CWB)											
	17.8 / 12.2		21.1 / 15.6		23.9 / 17.2		26.7 / 19.4		29.4 / 21.7		32.2 / 22.8	
	TC	SHC	TC	SHC	TC	SHC	TC	SHC	TC	SHC	TC	SHC
-10.0	2.25	1.54	2.54	1.75	2.68	2.02	2.87	2.27	3.07	2.48	3.17	2.84
-5.0	2.25	1.54	2.54	1.75	2.68	2.02	2.87	2.27	3.07	2.48	3.17	2.84
0.0	2.25	1.54	2.54	1.75	2.68	2.02	2.87	2.27	3.07	2.48	3.17	2.84
5.0	2.25	1.54	2.54	1.75	2.68	2.02	2.87	2.27	3.07	2.48	3.17	2.84
10.0	2.25	1.54	2.54	1.75	2.68	2.02	2.87	2.27	3.07	2.48	3.17	2.84
15.0	2.25	1.54	2.54	1.75	2.68	2.02	2.87	2.27	3.07	2.48	3.17	2.84
20.0	2.25	1.54	2.54	1.75	2.68	2.02	2.87	2.27	3.07	2.48	3.17	2.84
25.0	2.25	1.54	2.54	1.75	2.68	2.02	2.87	2.27	3.07	2.48	3.17	2.84
30.0	2.25	1.54	2.54	1.75	2.68	2.02	2.87	2.27	3.07	2.48	3.17	2.84
35.0	2.25	1.54	2.54	1.75	2.68	2.02	2.87	2.27	3.07	2.48	3.17	2.84
40.0	2.13	1.38	2.41	1.57	2.54	1.81	2.72	2.03	2.91	2.22	2.99	2.55
46.1	2.01	1.23	2.27	1.40	2.39	1.61	2.56	1.81	2.74	1.98	2.82	2.26

MODEL: AGU12RLF

Outdoor temperature (°CDB)	Indoor temperature (°CDB / °CWB)											
	17.8 / 12.2		21.1 / 15.6		23.9 / 17.2		26.7 / 19.4		29.4 / 21.7		32.2 / 22.8	
	TC	SHC	TC	SHC	TC	SHC	TC	SHC	TC	SHC	TC	SHC
-10.0	2.99	1.91	3.38	2.18	3.56	2.51	3.81	2.82	4.07	3.08	4.20	3.53
-5.0	2.99	1.91	3.38	2.18	3.56	2.51	3.81	2.82	4.07	3.08	4.20	3.53
0.0	2.99	1.91	3.38	2.18	3.56	2.51	3.81	2.82	4.07	3.08	4.20	3.53
5.0	2.99	1.91	3.38	2.18	3.56	2.51	3.81	2.82	4.07	3.08	4.20	3.53
10.0	2.99	1.91	3.38	2.18	3.56	2.51	3.81	2.82	4.07	3.08	4.20	3.53
15.0	2.99	1.91	3.38	2.18	3.56	2.51	3.81	2.82	4.07	3.08	4.20	3.53
20.0	2.99	1.91	3.38	2.18	3.56	2.51	3.81	2.82	4.07	3.08	4.20	3.53
25.0	2.99	1.91	3.38	2.18	3.56	2.51	3.81	2.82	4.07	3.08	4.20	3.53
30.0	2.99	1.91	3.38	2.18	3.56	2.51	3.81	2.82	4.07	3.08	4.20	3.53
35.0	2.99	1.91	3.38	2.18	3.56	2.51	3.81	2.82	4.07	3.08	4.20	3.53
40.0	2.83	1.71	3.19	1.95	3.37	2.25	3.61	2.52	3.85	2.76	3.97	3.16
46.1	2.67	1.52	3.01	1.74	3.18	2.00	3.40	2.25	3.63	2.46	3.75	2.81

MODEL: AGU15RLF

Outdoor temperature (°CDB)	Indoor temperature (°CDB / °CWB)											
	17.8 / 12.2		21.1 / 15.6		23.9 / 17.2		26.7 / 19.4		29.4 / 21.7		32.2 / 22.8	
	TC	SHC	TC	SHC	TC	SHC	TC	SHC	TC	SHC	TC	SHC
-10.0	3.75	2.33	4.23	2.66	4.46	3.06	4.78	3.44	5.11	3.76	5.26	4.31
-5.0	3.75	2.33	4.23	2.66	4.46	3.06	4.78	3.44	5.11	3.76	5.26	4.31
0.0	3.75	2.33	4.23	2.66	4.46	3.06	4.78	3.44	5.11	3.76	5.26	4.31
5.0	3.75	2.33	4.23	2.66	4.46	3.06	4.78	3.44	5.11	3.76	5.26	4.31
10.0	3.75	2.33	4.23	2.66	4.46	3.06	4.78	3.44	5.11	3.76	5.26	4.31
15.0	3.75	2.33	4.23	2.66	4.46	3.06	4.78	3.44	5.11	3.76	5.26	4.31
20.0	3.75	2.33	4.23	2.66	4.46	3.06	4.78	3.44	5.11	3.76	5.26	4.31
25.0	3.75	2.33	4.23	2.66	4.46	3.06	4.78	3.44	5.11	3.76	5.26	4.31
30.0	3.75	2.33	4.23	2.66	4.46	3.06	4.78	3.44	5.11	3.76	5.26	4.31
35.0	3.75	2.33	4.23	2.66	4.46	3.06	4.78	3.44	5.11	3.76	5.26	4.31
40.0	3.54	2.09	4.00	2.38	4.22	2.74	4.52	3.08	4.83	3.37	4.98	3.86
46.1	3.34	1.86	3.78	2.12	3.98	2.44	4.26	2.74	4.56	3.00	4.70	3.43

6-3. Heating capacity

Model: AOU36RLXFZH

NOTE: Values mentioned in the table are calculated based on the maximum capacity.

Heating capacity in kBtu/h

TC: Total Capacity (kBtu/h), IP: Input Power (kW)

Indoor unit connecting capacity	Outdoor temperature		Indoor temperature									
			60 °FDB		65 °FDB		70 °FDB		75 °FDB		78 °FDB	
	kBtu/h	°FDB	°FWB	TC	IP	TC	IP	TC	IP	TC	IP	TC
39	-15	-17	23.3	3.46	22.7	3.53	22.1	3.60	21.6	3.67	21.0	3.74
	-5	-7	26.4	3.65	25.8	3.72	25.1	3.80	24.5	3.88	23.9	3.95
	5	3	38.2	5.08	37.3	5.18	36.4	5.29	35.5	5.40	34.6	5.50
	14	12	40.6	5.01	39.6	5.12	38.6	5.22	37.7	5.32	36.7	5.43
	23	19	42.9	4.76	41.9	4.86	40.8	4.96	39.8	5.06	38.8	5.16
	32	28	44.1	4.57	43.1	4.66	42.0	4.76	41.0	4.86	39.9	4.95
	41	37	44.1	3.94	43.1	4.02	42.0	4.10	41.0	4.18	39.9	4.26
	47	43	44.1	3.21	43.1	3.28	42.0	3.35	41.0	3.41	39.9	3.48
	50	47	44.1	3.20	43.1	3.27	42.0	3.34	41.0	3.40	39.9	3.47
	59	50	44.1	3.18	43.1	3.25	42.0	3.31	41.0	3.38	39.9	3.45
38	-15	-17	23.3	3.46	22.7	3.53	22.1	3.60	21.6	3.67	21.0	3.74
	-5	-7	26.4	3.65	25.8	3.72	25.1	3.80	24.5	3.88	23.9	3.95
	5	3	38.2	5.08	37.3	5.18	36.4	5.29	35.5	5.40	34.6	5.50
	14	12	40.6	5.01	39.6	5.12	38.6	5.22	37.7	5.32	36.7	5.43
	23	19	42.9	4.76	41.9	4.86	40.8	4.96	39.8	5.06	38.8	5.16
	32	28	44.1	4.57	43.1	4.66	42.0	4.76	41.0	4.86	39.9	4.95
	41	37	44.1	3.94	43.1	4.02	42.0	4.10	41.0	4.18	39.9	4.26
	47	43	44.1	3.21	43.1	3.28	42.0	3.35	41.0	3.41	39.9	3.48
	50	47	44.1	3.20	43.1	3.27	42.0	3.34	41.0	3.40	39.9	3.47
	59	50	44.1	3.18	43.1	3.25	42.0	3.31	41.0	3.38	39.9	3.45
37	-15	-17	23.3	3.46	22.7	3.53	22.1	3.60	21.6	3.67	21.0	3.74
	-5	-7	26.4	3.65	25.8	3.72	25.1	3.80	24.5	3.88	23.9	3.95
	5	3	38.2	5.08	37.3	5.18	36.4	5.29	35.5	5.40	34.6	5.50
	14	12	40.6	5.01	39.6	5.12	38.6	5.22	37.7	5.32	36.7	5.43
	23	19	42.9	4.76	41.9	4.86	40.8	4.96	39.8	5.06	38.8	5.16
	32	28	44.1	4.57	43.1	4.66	42.0	4.76	41.0	4.86	39.9	4.95
	41	37	44.1	3.94	43.1	4.02	42.0	4.10	41.0	4.18	39.9	4.26
	47	43	44.1	3.21	43.1	3.28	42.0	3.35	41.0	3.41	39.9	3.48
	50	47	44.1	3.20	43.1	3.27	42.0	3.34	41.0	3.40	39.9	3.47
	59	50	44.1	3.18	43.1	3.25	42.0	3.31	41.0	3.38	39.9	3.45
36	-15	-17	23.3	3.45	22.7	3.52	22.1	3.59	21.6	3.66	21.0	3.74
	-5	-7	26.4	3.64	25.8	3.72	25.1	3.79	24.5	3.87	23.9	3.94
	5	3	38.2	5.07	37.3	5.18	36.4	5.28	35.5	5.39	34.6	5.49
	14	12	40.6	5.01	39.6	5.11	38.6	5.21	37.7	5.32	36.7	5.42
	23	19	42.9	4.76	41.9	4.86	40.8	4.96	39.8	5.06	38.8	5.16
	32	28	44.1	4.57	43.1	4.66	42.0	4.76	41.0	4.85	39.9	4.95
	41	37	44.1	3.94	43.1	4.02	42.0	4.10	41.0	4.18	39.9	4.26
	47	43	44.1	3.21	43.1	3.28	42.0	3.35	41.0	3.41	39.9	3.48
	50	47	44.1	3.20	43.1	3.27	42.0	3.34	41.0	3.40	39.9	3.47
	59	50	44.1	3.18	43.1	3.25	42.0	3.31	41.0	3.38	39.9	3.45
35	-15	-17	22.6	3.35	22.1	3.42	21.5	3.49	21.0	3.56	20.5	3.63
	-5	-7	25.6	3.53	25.0	3.61	24.4	3.68	23.8	3.75	23.2	3.83
	5	3	37.2	4.92	36.3	5.03	35.4	5.13	34.5	5.23	33.6	5.34
	14	12	39.4	4.86	38.5	4.96	37.6	5.06	36.6	5.16	35.7	5.26
	23	19	41.7	4.62	40.7	4.71	39.7	4.81	38.7	4.91	37.7	5.00
	32	28	42.9	4.44	41.9	4.53	40.8	4.62	39.8	4.71	38.8	4.80
	41	37	42.9	3.82	41.9	3.90	40.8	3.98	39.8	4.06	38.8	4.14
	47	43	42.9	3.11	41.9	3.18	40.8	3.24	39.8	3.31	38.8	3.37
	50	47	42.9	3.11	41.9	3.17	40.8	3.24	39.8	3.30	38.8	3.37
	59	50	42.9	3.08	41.9	3.15	40.8	3.21	39.8	3.28	38.8	3.34
75	65	42.9	2.96	41.9	3.02	40.8	3.08	39.8	3.14	38.8	3.20	
75	65	42.9	2.86	41.9	2.92	40.8	2.98	39.8	3.04	38.8	3.10	

OUTDOOR UNIT
AOU36RLXFZH

Indoor unit connecting capacity	Outdoor temperature		Indoor temperature									
			60 °FDB		65 °FDB		70 °FDB		75 °FDB		78 °FDB	
	kBtu/h	°FDB	°FWB	TC	IP	TC	IP	TC	IP	TC	IP	TC
34	-15	-17	22.0	3.24	21.4	3.31	20.9	3.38	20.4	3.45	19.9	3.52
	-5	-7	24.9	3.43	24.3	3.50	23.7	3.57	23.1	3.64	22.5	3.71
	5	3	36.1	4.77	35.2	4.87	34.4	4.97	33.5	5.07	32.7	5.17
	14	12	38.3	4.70	37.4	4.80	36.5	4.90	35.6	5.00	34.7	5.10
	23	19	40.5	4.47	39.5	4.57	38.6	4.66	37.6	4.75	36.7	4.85
	32	28	41.7	4.30	40.7	4.39	39.7	4.48	38.7	4.57	37.7	4.66
	41	37	41.7	3.71	40.7	3.78	39.7	3.86	38.7	3.94	37.7	4.01
	47	43	41.7	3.02	40.7	3.08	39.7	3.14	38.7	3.21	37.7	3.27
	50	47	41.7	3.01	40.7	3.07	39.7	3.14	38.7	3.20	37.7	3.26
	59	50	41.7	2.99	40.7	3.05	39.7	3.11	38.7	3.17	37.7	3.24
68	59	41.7	2.86	40.7	2.92	39.7	2.98	38.7	3.04	37.7	3.10	
75	65	41.7	2.77	40.7	2.83	39.7	2.88	38.7	2.94	37.7	3.00	
33	-15	-17	21.3	3.14	20.8	3.20	20.3	3.27	19.8	3.34	19.3	3.40
	-5	-7	24.2	3.31	23.6	3.38	23.0	3.45	22.5	3.52	21.9	3.59
	5	3	35.0	4.62	34.2	4.71	33.4	4.81	32.5	4.91	31.7	5.00
	14	12	37.2	4.56	36.3	4.66	35.4	4.75	34.5	4.85	33.6	4.94
	23	19	39.3	4.33	38.4	4.42	37.4	4.51	36.5	4.60	35.6	4.69
	32	28	40.4	4.16	39.5	4.24	38.5	4.33	37.5	4.42	36.6	4.50
	41	37	40.4	3.58	39.5	3.66	38.5	3.73	37.5	3.80	36.6	3.88
	47	43	40.4	2.92	39.5	2.98	38.5	3.04	37.5	3.10	36.6	3.16
	50	47	40.4	2.91	39.5	2.97	38.5	3.03	37.5	3.10	36.6	3.16
	59	50	40.4	2.89	39.5	2.95	38.5	3.01	37.5	3.07	36.6	3.13
68	59	40.4	2.77	39.5	2.83	38.5	2.89	37.5	2.95	36.6	3.00	
75	65	40.4	2.68	39.5	2.74	38.5	2.79	37.5	2.85	36.6	2.90	
32	-15	-17	20.7	3.03	20.2	3.09	19.7	3.16	19.2	3.22	18.7	3.28
	-5	-7	23.4	3.20	22.9	3.27	22.3	3.33	21.8	3.40	21.2	3.47
	5	3	34.0	4.46	33.2	4.55	32.4	4.64	31.5	4.74	30.7	4.83
	14	12	36.1	4.40	35.2	4.49	34.3	4.58	33.5	4.67	32.6	4.77
	23	19	38.1	4.18	37.2	4.27	36.3	4.36	35.4	4.45	34.5	4.53
	32	28	39.2	4.02	38.3	4.10	37.3	4.18	36.4	4.27	35.5	4.35
	41	37	39.2	3.46	38.3	3.53	37.3	3.60	36.4	3.68	35.5	3.75
	47	43	39.2	2.82	38.3	2.88	37.3	2.94	36.4	3.00	35.5	3.06
	50	47	39.2	2.82	38.3	2.88	37.3	2.93	36.4	2.99	35.5	3.05
	59	50	39.2	2.80	38.3	2.85	37.3	2.91	36.4	2.97	35.5	3.03
68	59	39.2	2.68	38.3	2.74	37.3	2.79	36.4	2.85	35.5	2.90	
75	65	39.2	2.59	38.3	2.64	37.3	2.70	36.4	2.75	35.5	2.81	
31	-15	-17	20.0	2.93	19.5	2.99	19.1	3.05	18.6	3.11	18.1	3.17
	-5	-7	22.7	3.09	22.2	3.16	21.6	3.22	21.1	3.28	20.6	3.35
	5	3	32.9	4.31	32.1	4.40	31.3	4.49	30.6	4.58	29.8	4.67
	14	12	34.9	4.25	34.1	4.34	33.3	4.43	32.4	4.52	31.6	4.61
	23	19	36.9	4.04	36.1	4.13	35.2	4.21	34.3	4.29	33.4	4.38
	32	28	38.0	3.88	37.1	3.96	36.2	4.04	35.3	4.12	34.4	4.20
	41	37	38.0	3.34	37.1	3.41	36.2	3.48	35.3	3.55	34.4	3.62
	47	43	38.0	2.73	37.1	2.78	36.2	2.84	35.3	2.90	34.4	2.95
	50	47	38.0	2.72	37.1	2.78	36.2	2.83	35.3	2.89	34.4	2.95
	59	50	38.0	2.70	37.1	2.76	36.2	2.81	35.3	2.87	34.4	2.92
68	59	38.0	2.59	37.1	2.64	36.2	2.70	35.3	2.75	34.4	2.80	
75	65	38.0	2.50	37.1	2.55	36.2	2.61	35.3	2.66	34.4	2.71	
30	-15	-17	19.4	2.83	18.9	2.89	18.5	2.95	18.0	3.01	17.5	3.07
	-5	-7	22.0	2.99	21.5	3.05	20.9	3.11	20.4	3.17	19.9	3.23
	5	3	31.9	4.16	31.1	4.24	30.3	4.33	29.6	4.42	28.8	4.50
	14	12	33.8	4.10	33.0	4.18	32.2	4.27	31.4	4.36	30.6	4.44
	23	19	35.7	3.90	34.9	3.98	34.0	4.06	33.2	4.14	32.3	4.22
	32	28	36.8	3.74	35.9	3.82	35.0	3.90	34.1	3.98	33.3	4.06
	41	37	36.8	3.23	35.9	3.29	35.0	3.36	34.1	3.43	33.3	3.49
	47	43	36.8	2.63	35.9	2.68	35.0	2.74	34.1	2.79	33.3	2.85
	50	47	36.8	2.62	35.9	2.68	35.0	2.73	34.1	2.79	33.3	2.84
	59	50	36.8	2.60	35.9	2.66	35.0	2.71	34.1	2.77	33.3	2.82
68	59	36.8	2.50	35.9	2.55	35.0	2.60	34.1	2.65	33.3	2.70	
75	65	36.8	2.41	35.9	2.46	35.0	2.51	34.1	2.56	33.3	2.61	
29	-15	-17	18.7	2.72	18.3	2.78	17.8	2.83	17.4	2.89	16.9	2.95
	-5	-7	21.2	2.87	20.7	2.93	20.2	2.99	19.7	3.05	19.2	3.11
	5	3	30.8	4.00	30.1	4.08	29.3	4.16	28.6	4.25	27.9	4.33
	14	12	32.7	3.95	31.9	4.03	31.1	4.11	30.3	4.19	29.6	4.27
	23	19	34.6	3.75	33.7	3.83	32.9	3.91	32.1	3.99	31.3	4.06
	32	28	35.5	3.60	34.7	3.68	33.8	3.75	33.0	3.83	32.1	3.90
	41	37	35.5	3.10	34.7	3.17	33.8	3.23	33.0	3.30	32.1	3.36
	47	43	35.5	2.53	34.7	2.58	33.8	2.64	33.0	2.69	32.1	2.74
	50	47	35.5	2.53	34.7	2.58	33.8	2.63	33.0	2.68	32.1	2.74
	59	50	35.5	2.51	34.7	2.56	33.8	2.61	33.0	2.66	32.1	2.72
68	59	35.5	2.40	34.7	2.45	33.8	2.50	33.0	2.55	32.1	2.60	
75	65	35.5	2.32	34.7	2.37	33.8	2.42	33.0	2.47	32.1	2.52	

Indoor unit connecting capacity	Outdoor temperature		Indoor temperature									
			60 °FDB		65 °FDB		70 °FDB		75 °FDB		78 °FDB	
	°FDB	°FWB	TC	IP	TC	IP	TC	IP	TC	IP	TC	IP
28	-15	-17	18.1	2.62	17.7	2.68	17.2	2.73	16.8	2.78	16.4	2.84
	-5	-7	20.5	2.76	20.0	2.82	19.5	2.88	19.1	2.94	18.6	3.00
	5	3	29.7	3.85	29.0	3.93	28.3	4.01	27.6	4.09	26.9	4.17
	14	12	31.6	3.80	30.8	3.88	30.0	3.96	29.3	4.04	28.5	4.12
	23	19	33.4	3.61	32.6	3.68	31.8	3.76	31.0	3.84	30.2	3.91
	32	28	34.3	3.47	33.5	3.54	32.7	3.61	31.9	3.68	31.0	3.75
	41	37	34.3	2.99	33.5	3.05	32.7	3.11	31.9	3.17	31.0	3.23
	47	43	34.3	2.43	33.5	2.49	32.7	2.54	31.9	2.59	31.0	2.64
	50	47	34.3	2.43	33.5	2.48	32.7	2.53	31.9	2.58	31.0	2.63
	59	50	34.3	2.41	33.5	2.46	32.7	2.51	31.9	2.56	31.0	2.61
	68	59	34.3	2.31	33.5	2.36	32.7	2.41	31.9	2.46	31.0	2.50
27	-15	-17	17.4	2.51	17.0	2.56	16.6	2.61	16.2	2.67	15.8	2.72
	-5	-7	19.8	2.65	19.3	2.70	18.8	2.76	18.4	2.81	17.9	2.87
	5	3	28.7	3.69	28.0	3.77	27.3	3.84	26.6	3.92	25.9	4.00
	14	12	30.4	3.64	29.7	3.72	29.0	3.79	28.3	3.87	27.5	3.95
	23	19	32.2	3.46	31.4	3.54	30.6	3.61	29.9	3.68	29.1	3.75
	32	28	33.1	3.32	32.3	3.39	31.5	3.46	30.7	3.53	29.9	3.60
	41	37	33.1	2.86	32.3	2.92	31.5	2.98	30.7	3.04	29.9	3.10
	47	43	33.1	2.34	32.3	2.39	31.5	2.44	30.7	2.48	29.9	2.53
	50	47	33.1	2.33	32.3	2.38	31.5	2.43	30.7	2.48	29.9	2.53
	59	50	33.1	2.31	32.3	2.36	31.5	2.41	30.7	2.46	29.9	2.51
	68	59	33.1	2.22	32.3	2.27	31.5	2.31	30.7	2.36	29.9	2.40
75	65	33.1	2.14	32.3	2.19	31.5	2.23	30.7	2.28	29.9	2.32	

NOTE:

Specifications are based on the following conditions.

- Power source of specifications: 230 V
- 2 or more indoor units should be connected.
- Pipe length: 24.6 ft (7.5 m), Height difference: 0 ft (0 m) [Outdoor unit - Indoor unit]
- The total ability of connected a indoor unit is up to 39,000 Btu from 27,000 Btu.
- Input in the table are calculated based on the maximum indoor unit input combinations.

● Heating capacity in kW

TC: Total Capacity (kW), IP: Input Power (kW)

OUTDOOR UNIT
AOU36RLXFZH

Indoor unit connecting capacity	Outdoor temperature		Indoor temperature									
			15.6 °CDB		18.3 °CDB		21.1 °CDB		23.9 °CDB		25.6 °CDB	
	kBtu/h	°CDB	°CWB	TC	IP	TC	IP	TC	IP	TC	IP	TC
39	-26.1	-27.0	6.81	3.46	6.65	3.53	6.40	3.60	6.32	3.67	6.16	3.74
	-20.6	-21.7	7.73	3.65	7.54	3.72	7.30	3.80	7.17	3.88	6.99	3.95
	-15.0	-16.1	11.20	5.08	10.93	5.18	10.60	5.29	10.40	5.40	10.13	5.50
	-10.0	-11.1	11.88	5.01	11.60	5.12	11.30	5.22	11.04	5.32	10.75	5.43
	-5.0	-7.2	12.57	4.76	12.27	4.86	11.90	4.96	11.67	5.06	11.37	5.16
	0.0	-2.2	12.92	4.57	12.61	4.66	12.30	4.76	12.00	4.86	11.69	4.95
	5.0	2.8	12.92	3.94	12.61	4.02	12.30	4.10	12.00	4.18	11.69	4.26
	8.3	6.1	12.92	3.21	12.61	3.28	12.30	3.35	12.00	3.41	11.69	3.48
	10.0	8.3	12.92	3.20	12.61	3.27	12.30	3.34	12.00	3.40	11.69	3.47
	15.0	10.0	12.92	3.18	12.61	3.25	12.30	3.31	12.00	3.38	11.69	3.45
20.0	15.0	12.92	3.05	12.61	3.11	12.30	3.18	12.00	3.24	11.69	3.30	
23.9	18.3	12.92	2.95	12.61	3.01	12.30	3.07	12.00	3.13	11.69	3.19	
38	-26.1	-27.0	6.81	3.46	6.65	3.53	6.40	3.60	6.32	3.67	6.16	3.74
	-20.6	-21.7	7.73	3.65	7.54	3.72	7.30	3.80	7.17	3.88	6.99	3.95
	-15.0	-16.1	11.20	5.08	10.93	5.18	10.60	5.29	10.40	5.40	10.13	5.50
	-10.0	-11.1	11.88	5.01	11.60	5.12	11.30	5.22	11.04	5.32	10.75	5.43
	-5.0	-7.2	12.57	4.76	12.27	4.86	11.90	4.96	11.67	5.06	11.37	5.16
	0.0	-2.2	12.92	4.57	12.61	4.66	12.30	4.76	12.00	4.86	11.69	4.95
	5.0	2.8	12.92	3.94	12.61	4.02	12.30	4.10	12.00	4.18	11.69	4.26
	8.3	6.1	12.92	3.21	12.61	3.28	12.30	3.35	12.00	3.41	11.69	3.48
	10.0	8.3	12.92	3.20	12.61	3.27	12.30	3.34	12.00	3.40	11.69	3.47
	15.0	10.0	12.92	3.18	12.61	3.25	12.30	3.31	12.00	3.38	11.69	3.45
20.0	15.0	12.92	3.05	12.61	3.11	12.30	3.18	12.00	3.24	11.69	3.30	
23.9	18.3	12.92	2.95	12.61	3.01	12.30	3.07	12.00	3.13	11.69	3.19	
37	-26.1	-27.0	6.81	3.46	6.65	3.53	6.40	3.60	6.32	3.67	6.16	3.74
	-20.6	-21.7	7.73	3.65	7.54	3.72	7.30	3.80	7.17	3.88	6.99	3.95
	-15.0	-16.1	11.20	5.08	10.93	5.18	10.60	5.29	10.40	5.40	10.13	5.50
	-10.0	-11.1	11.88	5.01	11.60	5.12	11.30	5.22	11.04	5.32	10.75	5.43
	-5.0	-7.2	12.57	4.76	12.27	4.86	11.90	4.96	11.67	5.06	11.37	5.16
	0.0	-2.2	12.92	4.57	12.61	4.66	12.30	4.76	12.00	4.86	11.69	4.95
	5.0	2.8	12.92	3.94	12.61	4.02	12.30	4.10	12.00	4.18	11.69	4.26
	8.3	6.1	12.92	3.21	12.61	3.28	12.30	3.35	12.00	3.41	11.69	3.48
	10.0	8.3	12.92	3.20	12.61	3.27	12.30	3.34	12.00	3.40	11.69	3.47
	15.0	10.0	12.92	3.18	12.61	3.25	12.30	3.31	12.00	3.38	11.69	3.45
20.0	15.0	12.92	3.05	12.61	3.11	12.30	3.18	12.00	3.24	11.69	3.30	
23.9	18.3	12.92	2.95	12.61	3.01	12.30	3.07	12.00	3.13	11.69	3.19	
36	-26.1	-27.0	6.81	3.45	6.65	3.52	6.40	3.59	6.32	3.66	6.16	3.74
	-20.6	-21.7	7.73	3.64	7.54	3.72	7.30	3.79	7.17	3.87	6.99	3.94
	-15.0	-16.1	11.20	5.07	10.93	5.18	10.60	5.28	10.40	5.39	10.13	5.49
	-10.0	-11.1	11.88	5.01	11.60	5.11	11.30	5.21	11.04	5.32	10.75	5.42
	-5.0	-7.2	12.57	4.76	12.27	4.86	11.90	4.96	11.67	5.06	11.37	5.16
	0.0	-2.2	12.92	4.57	12.61	4.66	12.30	4.76	12.00	4.85	11.69	4.95
	5.0	2.8	12.92	3.94	12.61	4.02	12.30	4.10	12.00	4.18	11.69	4.26
	8.3	6.1	12.92	3.21	12.61	3.28	12.30	3.35	12.00	3.41	11.69	3.48
	10.0	8.3	12.92	3.20	12.61	3.27	12.30	3.34	12.00	3.40	11.69	3.47
	15.0	10.0	12.92	3.18	12.61	3.25	12.30	3.31	12.00	3.38	11.69	3.45
20.0	15.0	12.92	3.05	12.61	3.11	12.30	3.18	12.00	3.24	11.69	3.30	
23.9	18.3	12.92	2.95	12.61	3.01	12.30	3.07	12.00	3.13	11.69	3.19	
35	-26.1	-27.0	6.43	3.24	6.28	3.31	6.10	3.38	5.97	3.45	5.82	3.52
	-20.6	-21.7	7.30	3.43	7.12	3.50	6.90	3.57	6.77	3.64	6.60	3.71
	-15.0	-16.1	10.57	4.77	10.32	4.87	10.00	4.97	9.82	5.07	9.57	5.17
	-10.0	-11.1	11.22	4.70	10.96	4.80	10.60	4.90	10.42	5.00	10.15	5.10
	-5.0	-7.2	11.87	4.47	11.58	4.57	11.30	4.66	11.02	4.75	10.74	4.85
	0.0	-2.2	12.20	4.30	11.91	4.39	11.60	4.48	11.33	4.57	11.04	4.66
	5.0	2.8	12.20	3.71	11.91	3.78	11.60	3.86	11.33	3.94	11.04	4.01
	8.3	6.1	12.20	3.02	11.91	3.08	11.60	3.14	11.33	3.21	11.04	3.27
	10.0	8.3	12.20	3.01	11.91	3.07	11.60	3.14	11.33	3.20	11.04	3.26
	15.0	10.0	12.20	2.99	11.91	3.05	11.60	3.11	11.33	3.17	11.04	3.24
20.0	15.0	12.20	2.86	11.91	2.92	11.60	2.98	11.33	3.04	11.04	3.10	
23.9	18.3	12.20	2.77	11.91	2.83	11.60	2.88	11.33	2.94	11.04	3.00	
34	-26.1	-27.0	6.43	3.24	6.28	3.31	6.10	3.38	5.97	3.45	5.82	3.52
	-20.6	-21.7	7.30	3.43	7.12	3.50	6.90	3.57	6.77	3.64	6.60	3.71
	-15.0	-16.1	10.57	4.77	10.32	4.87	10.00	4.97	9.82	5.07	9.57	5.17
	-10.0	-11.1	11.22	4.70	10.96	4.80	10.60	4.90	10.42	5.00	10.15	5.10
	-5.0	-7.2	11.87	4.47	11.58	4.57	11.30	4.66	11.02	4.75	10.74	4.85
	0.0	-2.2	12.20	4.30	11.91	4.39	11.60	4.48	11.33	4.57	11.04	4.66
	5.0	2.8	12.20	3.71	11.91	3.78	11.60	3.86	11.33	3.94	11.04	4.01
	8.3	6.1	12.20	3.02	11.91	3.08	11.60	3.14	11.33	3.21	11.04	3.27
	10.0	8.3	12.20	3.01	11.91	3.07	11.60	3.14	11.33	3.20	11.04	3.26
	15.0	10.0	12.20	2.99	11.91	3.05	11.60	3.11	11.33	3.17	11.04	3.24
20.0	15.0	12.20	2.86	11.91	2.92	11.60	2.98	11.33	3.04	11.04	3.10	
23.9	18.3	12.20	2.77	11.91	2.83	11.60	2.88	11.33	2.94	11.04	3.00	

Indoor unit connecting capacity	Outdoor temperature		Indoor temperature									
			15.6 °CDB		18.3 °CDB		21.1 °CDB		23.9 °CDB		25.6 °CDB	
	kBtu/h	°CDB	°CWB	TC	IP	TC	IP	TC	IP	TC	IP	TC
33	-26.1	-27.0	6.24	3.14	6.09	3.20	5.90	3.27	5.80	3.34	5.65	3.40
	-20.6	-21.7	7.08	3.31	6.91	3.38	6.70	3.45	6.58	3.52	6.41	3.59
	-15.0	-16.1	10.26	4.62	10.02	4.71	9.70	4.81	9.53	4.91	9.29	5.00
	-10.0	-11.1	10.89	4.56	10.63	4.66	10.30	4.75	10.12	4.85	9.86	4.94
	-5.0	-7.2	11.52	4.33	11.24	4.42	10.90	4.51	10.70	4.60	10.42	4.69
	0.0	-2.2	11.84	4.16	11.56	4.24	11.20	4.33	11.00	4.42	10.71	4.50
	5.0	2.8	11.84	3.58	11.56	3.66	11.20	3.73	11.00	3.80	10.71	3.88
	8.3	6.1	11.84	2.92	11.56	2.98	11.20	3.04	11.00	3.10	10.71	3.16
	10.0	8.3	11.84	2.91	11.56	2.97	11.20	3.03	11.00	3.10	10.71	3.16
	15.0	10.0	11.84	2.89	11.56	2.95	11.20	3.01	11.00	3.07	10.71	3.13
32	-26.1	-27.0	6.05	3.03	5.91	3.09	5.70	3.16	5.62	3.22	5.48	3.28
	-20.6	-21.7	6.87	3.20	6.70	3.27	6.50	3.33	6.38	3.40	6.21	3.47
	-15.0	-16.1	9.95	4.46	9.71	4.55	9.40	4.64	9.24	4.74	9.00	4.83
	-10.0	-11.1	10.56	4.40	10.31	4.49	10.00	4.58	9.81	4.67	9.56	4.77
	-5.0	-7.2	11.17	4.18	10.90	4.27	10.60	4.36	10.37	4.45	10.10	4.53
	0.0	-2.2	11.48	4.02	11.21	4.10	10.90	4.18	10.66	4.27	10.39	4.35
	5.0	2.8	11.48	3.46	11.21	3.53	10.90	3.60	10.66	3.68	10.39	3.75
	8.3	6.1	11.48	2.82	11.21	2.88	10.90	2.94	10.66	3.00	10.39	3.06
	10.0	8.3	11.48	2.82	11.21	2.88	10.90	2.93	10.66	2.99	10.39	3.05
	15.0	10.0	11.48	2.80	11.21	2.85	10.90	2.91	10.66	2.97	10.39	3.03
31	-26.1	-27.0	5.86	2.93	5.72	2.99	5.50	3.05	5.44	3.11	5.30	3.17
	-20.6	-21.7	6.65	3.09	6.49	3.16	6.30	3.22	6.18	3.28	6.02	3.35
	-15.0	-16.1	9.64	4.31	9.41	4.40	9.10	4.49	8.95	4.58	8.72	4.67
	-10.0	-11.1	10.23	4.25	9.99	4.34	9.70	4.43	9.50	4.52	9.26	4.61
	-5.0	-7.2	10.82	4.04	10.56	4.13	10.30	4.21	10.05	4.29	9.79	4.38
	0.0	-2.2	11.12	3.88	10.86	3.96	10.50	4.04	10.33	4.12	10.06	4.20
	5.0	2.8	11.12	3.34	10.86	3.41	10.50	3.48	10.33	3.55	10.06	3.62
	8.3	6.1	11.12	2.73	10.86	2.78	10.50	2.84	10.33	2.90	10.06	2.95
	10.0	8.3	11.12	2.72	10.86	2.78	10.50	2.83	10.33	2.89	10.06	2.95
	15.0	10.0	11.12	2.70	10.86	2.76	10.50	2.81	10.33	2.87	10.06	2.92
30	-26.1	-27.0	5.67	2.83	5.54	2.89	5.40	2.95	5.27	3.01	5.13	3.07
	-20.6	-21.7	6.44	2.99	6.28	3.05	6.10	3.11	5.98	3.17	5.82	3.23
	-15.0	-16.1	9.33	4.16	9.11	4.24	8.80	4.33	8.66	4.42	8.44	4.50
	-10.0	-11.1	9.90	4.10	9.67	4.18	9.40	4.27	9.20	4.36	8.96	4.44
	-5.0	-7.2	10.47	3.90	10.22	3.98	9.90	4.06	9.72	4.14	9.47	4.22
	0.0	-2.2	10.77	3.74	10.51	3.82	10.20	3.90	10.00	3.98	9.74	4.06
	5.0	2.8	10.77	3.23	10.51	3.29	10.20	3.36	10.00	3.43	9.74	3.49
	8.3	6.1	10.77	2.63	10.51	2.68	10.20	2.74	10.00	2.79	9.74	2.85
	10.0	8.3	10.77	2.62	10.51	2.68	10.20	2.73	10.00	2.79	9.74	2.84
	15.0	10.0	10.77	2.60	10.51	2.66	10.20	2.71	10.00	2.77	9.74	2.82
29	-26.1	-27.0	5.48	2.72	5.35	2.78	5.20	2.83	5.09	2.89	4.96	2.95
	-20.6	-21.7	6.22	2.87	6.07	2.93	5.90	2.99	5.78	3.05	5.63	3.11
	-15.0	-16.1	9.02	4.00	8.80	4.08	8.50	4.16	8.37	4.25	8.16	4.33
	-10.0	-11.1	9.57	3.95	9.34	4.03	9.10	4.11	8.89	4.19	8.66	4.27
	-5.0	-7.2	10.12	3.75	9.88	3.83	9.60	3.91	9.40	3.99	9.16	4.06
	0.0	-2.2	10.41	3.60	10.16	3.68	9.90	3.75	9.66	3.83	9.42	3.90
	5.0	2.8	10.41	3.10	10.16	3.17	9.90	3.23	9.66	3.30	9.42	3.36
	8.3	6.1	10.41	2.53	10.16	2.58	9.90	2.64	9.66	2.69	9.42	2.74
	10.0	8.3	10.41	2.53	10.16	2.58	9.90	2.63	9.66	2.68	9.42	2.74
	15.0	10.0	10.41	2.51	10.16	2.56	9.90	2.61	9.66	2.66	9.42	2.72
28	-26.1	-27.0	5.30	2.62	5.17	2.68	5.00	2.73	4.92	2.78	4.79	2.84
	-20.6	-21.7	6.01	2.76	5.86	2.82	5.70	2.88	5.58	2.94	5.44	3.00
	-15.0	-16.1	8.71	3.85	8.50	3.93	8.20	4.01	8.09	4.09	7.88	4.17
	-10.0	-11.1	9.24	3.80	9.02	3.88	8.80	3.96	8.58	4.04	8.36	4.12
	-5.0	-7.2	9.77	3.61	9.54	3.68	9.30	3.76	9.07	3.84	8.84	3.91
	0.0	-2.2	10.05	3.47	9.81	3.54	9.50	3.61	9.33	3.68	9.09	3.75
	5.0	2.8	10.05	2.99	9.81	3.05	9.50	3.11	9.33	3.17	9.09	3.23
	8.3	6.1	10.05	2.43	9.81	2.49	9.50	2.54	9.33	2.59	9.09	2.64
	10.0	8.3	10.05	2.43	9.81	2.48	9.50	2.53	9.33	2.58	9.09	2.63
	15.0	10.0	10.05	2.41	9.81	2.46	9.50	2.51	9.33	2.56	9.09	2.61

OUTDOOR UNIT
AOU36RLXFZH

Indoor unit connecting capacity	Outdoor temperature		Indoor temperature									
			15.6 °CDB		18.3 °CDB		21.1 °CDB		23.9 °CDB		25.6 °CDB	
kBtu/h	°CDB	°CWB	TC	IP	TC	IP	TC	IP	TC	IP	TC	IP
27	-26.1	-27.0	5.11	2.51	4.98	2.56	4.80	2.61	4.74	2.67	4.62	2.72
	-20.6	-21.7	5.79	2.65	5.66	2.70	5.50	2.76	5.38	2.81	5.24	2.87
	-15.0	-16.1	8.40	3.69	8.20	3.77	8.00	3.84	7.80	3.92	7.60	4.00
	-10.0	-11.1	8.91	3.64	8.70	3.72	8.40	3.79	8.28	3.87	8.06	3.95
	-5.0	-7.2	9.42	3.46	9.20	3.54	8.90	3.61	8.75	3.68	8.53	3.75
	0.0	-2.2	9.69	3.32	9.46	3.39	9.20	3.46	9.00	3.53	8.77	3.60
	5.0	2.8	9.69	2.86	9.46	2.92	9.20	2.98	9.00	3.04	8.77	3.10
	8.3	6.1	9.69	2.34	9.46	2.39	9.20	2.44	9.00	2.48	8.77	2.53
	10.0	8.3	9.69	2.33	9.46	2.38	9.20	2.43	9.00	2.48	8.77	2.53
	15.0	10.0	9.69	2.31	9.46	2.36	9.20	2.41	9.00	2.46	8.77	2.51
	20.0	15.0	9.69	2.22	9.46	2.27	9.20	2.31	9.00	2.36	8.77	2.40
23.9	18.3	9.69	2.14	9.46	2.19	9.20	2.23	9.00	2.28	8.77	2.32	

NOTE:

Specifications are based on the following conditions.

- Power source of specifications: 230 V
- 2 or more indoor units should be connected.
- Pipe length: 24.6 ft (7.5 m), Height difference: 0 ft (0 m) [Outdoor unit - Indoor unit]
- The total ability of connected a indoor unit is up to 39,000 Btu from 27,000 Btu.
- Input in the table are calculated based on the maximum indoor unit input combinations.

■ Compact cassette type

● Heating capacity in kBtu/h

- TC: Total Capacity (kBtu/h).
- The data is based on the following conditions:
Pipe length: 24.6 ft (7.5 m), Height difference: 0 ft (0 m) [Outdoor unit - Indoor unit]

MODEL: AUU7RLF

Outdoor temperature		Indoor temperature (°FDB)				
		60.0	65.0	70.0	75.0	78.0
(°FDB)	(°FWB)	TC	TC	TC	TC	TC
5.0	3.0	5.03	4.91	4.79	4.67	4.55
14.0	12.0	5.67	5.54	5.40	5.27	5.13
23.0	19.0	6.31	6.16	6.01	5.86	5.71
32.0	28.0	7.35	7.18	7.00	6.83	6.65
41.0	37.0	8.40	8.20	8.00	7.80	7.60
47.0	43.0	8.61	8.41	8.20	8.00	7.79
50.0	47.0	8.61	8.41	8.20	8.00	7.79
59.0	50.0	8.61	8.41	8.20	8.00	7.79
68.0	59.0	8.22	8.02	7.83	7.63	7.43
75.0	65.0	7.83	7.65	7.46	7.27	7.09

MODEL: AUU9RLF

Outdoor temperature		Indoor temperature (°FDB)				
		60.0	65.0	70.0	75.0	78.0
(°FDB)	(°FWB)	TC	TC	TC	TC	TC
5.0	3.0	6.44	6.29	6.13	5.98	5.83
14.0	12.0	7.26	7.09	6.92	6.74	6.57
23.0	19.0	8.08	7.89	7.70	7.51	7.31
32.0	28.0	9.42	9.19	8.97	8.74	8.52
41.0	37.0	10.75	10.50	10.24	9.98	9.73
47.0	43.0	11.03	10.76	10.50	10.24	9.98
50.0	47.0	11.03	10.76	10.50	10.24	9.98
59.0	50.0	11.03	10.76	10.50	10.24	9.98
68.0	59.0	10.52	10.27	10.02	9.77	9.52
75.0	65.0	10.03	9.79	9.55	9.31	9.07

MODEL: AUU12RLF

Outdoor temperature		Indoor temperature (°FDB)				
		60.0	65.0	70.0	75.0	78.0
(°FDB)	(°FWB)	TC	TC	TC	TC	TC
5.0	3.0	8.59	8.38	8.18	7.97	7.77
14.0	12.0	9.68	9.45	9.22	8.99	8.76
23.0	19.0	10.78	10.52	10.26	10.01	9.75
32.0	28.0	12.56	12.26	11.96	11.66	11.36
41.0	37.0	14.33	13.99	13.65	13.31	12.97
47.0	43.0	14.70	14.35	14.00	13.65	13.30
50.0	47.0	14.70	14.35	14.00	13.65	13.30
59.0	50.0	14.70	14.35	14.00	13.65	13.30
68.0	59.0	14.03	13.69	13.36	13.03	12.69
75.0	65.0	13.37	13.05	12.74	12.42	12.10

MODEL: AUU18RLF

Outdoor temperature		Indoor temperature (°FDB)				
		60.0	65.0	70.0	75.0	78.0
(°FDB)	(°FWB)	TC	TC	TC	TC	TC
5.0	3.0	12.88	12.57	12.27	11.96	11.65
14.0	12.0	14.52	14.18	13.83	13.48	13.14
23.0	19.0	16.17	15.78	15.40	15.01	14.63
32.0	28.0	18.83	18.39	17.94	17.49	17.04
41.0	37.0	21.50	20.99	20.48	19.97	19.45
47.0	43.0	22.05	21.53	21.00	20.48	19.95
50.0	47.0	22.05	21.53	21.00	20.48	19.95
59.0	50.0	22.05	21.53	21.00	20.48	19.95
68.0	59.0	21.04	20.54	20.04	19.54	19.04
75.0	65.0	20.06	19.58	19.10	18.63	18.15

● Heating capacity in kW

- TC: Total Capacity (kW).
- The data is based on the following conditions:
Pipe length: 24.6 ft (7.5 m), Height difference: 0 ft (0 m) [Outdoor unit - Indoor unit]

MODEL: AUU7RLF

Outdoor temperature		Indoor temperature (°CDB)				
		15.6	18.3	21.1	23.9	25.6
(°CDB)	(°CWB)	TC	TC	TC	TC	TC
-15.0	-16.1	1.47	1.44	1.40	1.37	1.33
-10.0	-11.1	1.66	1.62	1.58	1.54	1.50
-5.0	-7.2	1.85	1.81	1.76	1.72	1.67
0.0	-2.2	2.16	2.10	2.05	2.00	1.95
5.0	2.8	2.46	2.40	2.34	2.29	2.23
8.3	6.1	2.52	2.46	2.40	2.34	2.28
10.0	8.3	2.52	2.46	2.40	2.34	2.28
15.0	10.0	2.52	2.46	2.40	2.34	2.28
20.0	15.0	2.41	2.35	2.29	2.24	2.18
23.9	18.3	2.30	2.24	2.19	2.13	2.08

MODEL: AUU9RLF

Outdoor temperature		Indoor temperature (°CDB)				
		15.6	18.3	21.1	23.9	25.6
(°CDB)	(°CWB)	TC	TC	TC	TC	TC
-15.0	-16.1	1.89	1.84	1.80	1.75	1.71
-10.0	-11.1	2.13	2.08	2.03	1.98	1.93
-5.0	-7.2	2.37	2.31	2.26	2.20	2.14
0.0	-2.2	2.76	2.69	2.63	2.56	2.50
5.0	2.8	3.15	3.08	3.00	2.93	2.85
8.3	6.1	3.23	3.15	3.08	3.00	2.92
10.0	8.3	3.23	3.15	3.08	3.00	2.92
15.0	10.0	3.23	3.15	3.08	3.00	2.92
20.0	15.0	3.08	3.01	2.94	2.86	2.79
23.9	18.3	2.94	2.87	2.80	2.73	2.66

MODEL: AUU12RLF

Outdoor temperature		Indoor temperature (°CDB)				
		15.6	18.3	21.1	23.9	25.6
(°CDB)	(°CWB)	TC	TC	TC	TC	TC
-15.0	-16.1	2.52	2.46	2.40	2.34	2.28
-10.0	-11.1	2.84	2.77	2.70	2.63	2.57
-5.0	-7.2	3.16	3.08	3.01	2.93	2.86
0.0	-2.2	3.68	3.59	3.50	3.42	3.33
5.0	2.8	4.20	4.10	4.00	3.90	3.80
8.3	6.1	4.31	4.21	4.10	4.00	3.90
10.0	8.3	4.31	4.21	4.10	4.00	3.90
15.0	10.0	4.31	4.21	4.10	4.00	3.90
20.0	15.0	4.11	4.01	3.92	3.82	3.72
23.9	18.3	3.92	3.83	3.73	3.64	3.55

MODEL: AUU18RLF

Outdoor temperature		Indoor temperature (°CDB)				
		15.6	18.3	21.1	23.9	25.6
(°CDB)	(°CWB)	TC	TC	TC	TC	TC
-15.0	-16.1	3.77	3.68	3.59	3.51	3.42
-10.0	-11.1	4.26	4.15	4.05	3.95	3.85
-5.0	-7.2	4.74	4.63	4.51	4.40	4.29
0.0	-2.2	5.52	5.39	5.26	5.13	4.99
5.0	2.8	6.30	6.15	6.00	5.85	5.70
8.3	6.1	6.46	6.31	6.15	6.00	5.85
10.0	8.3	6.46	6.31	6.15	6.00	5.85
15.0	10.0	6.46	6.31	6.15	6.00	5.85
20.0	15.0	6.17	6.02	5.87	5.73	5.58
23.9	18.3	5.88	5.74	5.60	5.46	5.32

■ Slim duct type

● Heating capacity in kBtu/h

- TC: Total Capacity (kBtu/h).
- The data is based on the following conditions:
Pipe length: 24.6 ft (7.5 m), Height difference: 0 ft (0 m) [Outdoor unit - Indoor unit]

MODEL: ARU7RLF

Outdoor temperature		Indoor temperature (°FDB)				
		60.0	65.0	70.0	75.0	78.0
(°FDB)	(°FWB)	TC	TC	TC	TC	TC
5.0	3.0	5.03	4.91	4.79	4.67	4.55
14.0	12.0	5.67	5.54	5.40	5.27	5.13
23.0	19.0	6.31	6.16	6.01	5.86	5.71
32.0	28.0	7.35	7.18	7.00	6.83	6.65
41.0	37.0	8.40	8.20	8.00	7.80	7.60
47.0	43.0	8.61	8.41	8.20	8.00	7.79
50.0	47.0	8.61	8.41	8.20	8.00	7.79
59.0	50.0	8.61	8.41	8.20	8.00	7.79
68.0	59.0	8.22	8.02	7.83	7.63	7.43
75.0	65.0	7.83	7.65	7.46	7.27	7.09

MODEL: ARU9RLF

Outdoor temperature		Indoor temperature (°FDB)				
		60.0	65.0	70.0	75.0	78.0
(°FDB)	(°FWB)	TC	TC	TC	TC	TC
5.0	3.0	6.44	6.29	6.13	5.98	5.83
14.0	12.0	7.26	7.09	6.92	6.74	6.57
23.0	19.0	8.08	7.89	7.70	7.51	7.31
32.0	28.0	9.42	9.19	8.97	8.74	8.52
41.0	37.0	10.75	10.50	10.24	9.98	9.73
47.0	43.0	11.03	10.76	10.50	10.24	9.98
50.0	47.0	11.03	10.76	10.50	10.24	9.98
59.0	50.0	11.03	10.76	10.50	10.24	9.98
68.0	59.0	10.52	10.27	10.02	9.77	9.52
75.0	65.0	10.03	9.79	9.55	9.31	9.07

MODEL: ARU12RLF

Outdoor temperature		Indoor temperature (°FDB)				
		60.0	65.0	70.0	75.0	78.0
(°FDB)	(°FWB)	TC	TC	TC	TC	TC
5.0	3.0	8.59	8.38	8.18	7.97	7.77
14.0	12.0	9.68	9.45	9.22	8.99	8.76
23.0	19.0	10.78	10.52	10.26	10.01	9.75
32.0	28.0	12.56	12.26	11.96	11.66	11.36
41.0	37.0	14.33	13.99	13.65	13.31	12.97
47.0	43.0	14.70	14.35	14.00	13.65	13.30
50.0	47.0	14.70	14.35	14.00	13.65	13.30
59.0	50.0	14.70	14.35	14.00	13.65	13.30
68.0	59.0	14.03	13.69	13.36	13.03	12.69
75.0	65.0	13.37	13.05	12.74	12.42	12.10

MODEL: ARU18RLF

Outdoor temperature		Indoor temperature (°FDB)				
		60.0	65.0	70.0	75.0	78.0
(°FDB)	(°FWB)	TC	TC	TC	TC	TC
5.0	3.0	12.88	12.57	12.27	11.96	11.65
14.0	12.0	14.52	14.18	13.83	13.48	13.14
23.0	19.0	16.17	15.78	15.40	15.01	14.63
32.0	28.0	18.83	18.39	17.94	17.49	17.04
41.0	37.0	21.50	20.99	20.48	19.97	19.45
47.0	43.0	22.05	21.53	21.00	20.48	19.95
50.0	47.0	22.05	21.53	21.00	20.48	19.95
59.0	50.0	22.05	21.53	21.00	20.48	19.95
68.0	59.0	21.04	20.54	20.04	19.54	19.04
75.0	65.0	20.06	19.58	19.10	18.63	18.15

MODEL: ARU24RLF

**OUTDOOR UNIT
AOU36RLXFZH**

Outdoor temperature		Indoor temperature (°FDB)				
		60.0	65.0	70.0	75.0	78.0
(°FDB)	(°FWB)	TC	TC	TC	TC	TC
5.0	3.0	16.25	15.87	15.48	15.09	14.70
14.0	12.0	18.33	17.89	17.45	17.02	16.58
23.0	19.0	20.40	19.91	19.43	18.94	18.46
32.0	28.0	23.77	23.20	22.63	22.07	21.50
41.0	37.0	27.13	26.49	25.84	25.20	24.55
47.0	43.0	27.83	27.16	26.50	25.84	25.18
50.0	47.0	27.83	27.16	26.50	25.84	25.18
59.0	50.0	27.83	27.16	26.50	25.84	25.18
68.0	59.0	26.55	25.92	25.29	24.66	24.03
75.0	65.0	25.31	24.71	24.11	23.50	22.90

● Heating capacity in kW

- TC: Total Capacity (kW).
- The data is based on the following conditions:
Pipe length: 24.6 ft (7.5 m), Height difference: 0 ft (0 m) [Outdoor unit - Indoor unit]

MODEL: ARU7RLF

Outdoor temperature		Indoor temperature (°CDB)				
		15.6	18.3	21.1	23.9	25.6
(°CDB)	(°CWB)	TC	TC	TC	TC	TC
-15.0	-16.1	1.47	1.44	1.40	1.37	1.33
-10.0	-11.1	1.66	1.62	1.58	1.54	1.50
-5.0	-7.2	1.85	1.81	1.76	1.72	1.67
0.0	-2.2	2.16	2.10	2.05	2.00	1.95
5.0	2.8	2.46	2.40	2.34	2.29	2.23
8.3	6.1	2.52	2.46	2.40	2.34	2.28
10.0	8.3	2.52	2.46	2.40	2.34	2.28
15.0	10.0	2.52	2.46	2.40	2.34	2.28
20.0	15.0	2.41	2.35	2.29	2.24	2.18
23.9	18.3	2.30	2.24	2.19	2.13	2.08

MODEL: ARU9RLF

Outdoor temperature		Indoor temperature (°CDB)				
		15.6	18.3	21.1	23.9	25.6
(°CDB)	(°CWB)	TC	TC	TC	TC	TC
-15.0	-16.1	1.89	1.84	1.80	1.75	1.71
-10.0	-11.1	2.13	2.08	2.03	1.98	1.93
-5.0	-7.2	2.37	2.31	2.26	2.20	2.14
0.0	-2.2	2.76	2.69	2.63	2.56	2.50
5.0	2.8	3.15	3.08	3.00	2.93	2.85
8.3	6.1	3.23	3.15	3.08	3.00	2.92
10.0	8.3	3.23	3.15	3.08	3.00	2.92
15.0	10.0	3.23	3.15	3.08	3.00	2.92
20.0	15.0	3.08	3.01	2.94	2.86	2.79
23.9	18.3	2.94	2.87	2.80	2.73	2.66

MODEL: ARU12RLF

Outdoor temperature		Indoor temperature (°CDB)				
		15.6	18.3	21.1	23.9	25.6
(°CDB)	(°CWB)	TC	TC	TC	TC	TC
-15.0	-16.1	2.52	2.46	2.40	2.34	2.28
-10.0	-11.1	2.84	2.77	2.70	2.63	2.57
-5.0	-7.2	3.16	3.08	3.01	2.93	2.86
0.0	-2.2	3.68	3.59	3.50	3.42	3.33
5.0	2.8	4.20	4.10	4.00	3.90	3.80
8.3	6.1	4.31	4.21	4.10	4.00	3.90
10.0	8.3	4.31	4.21	4.10	4.00	3.90
15.0	10.0	4.31	4.21	4.10	4.00	3.90
20.0	15.0	4.11	4.01	3.92	3.82	3.72
23.9	18.3	3.92	3.83	3.73	3.64	3.55

MODEL: ARU18RLF

Outdoor temperature		Indoor temperature (°CDB)				
		15.6	18.3	21.1	23.9	25.6
(°CDB)	(°CWB)	TC	TC	TC	TC	TC
-15.0	-16.1	3.77	3.68	3.59	3.51	3.42
-10.0	-11.1	4.26	4.15	4.05	3.95	3.85
-5.0	-7.2	4.74	4.63	4.51	4.40	4.29
0.0	-2.2	5.52	5.39	5.26	5.13	4.99
5.0	2.8	6.30	6.15	6.00	5.85	5.70
8.3	6.1	6.46	6.31	6.15	6.00	5.85
10.0	8.3	6.46	6.31	6.15	6.00	5.85
15.0	10.0	6.46	6.31	6.15	6.00	5.85
20.0	15.0	6.17	6.02	5.87	5.73	5.58
23.9	18.3	5.88	5.74	5.60	5.46	5.32

MODEL: ARU24RLF

Outdoor temperature		Indoor temperature (°CDB)				
		15.6	18.3	21.1	23.9	25.6
(°CDB)	(°CWB)	TC	TC	TC	TC	TC
-15.0	-16.1	4.76	4.65	4.54	4.42	4.31
-10.0	-11.1	5.37	5.24	5.12	4.99	4.86
-5.0	-7.2	5.98	5.84	5.69	5.55	5.41
0.0	-2.2	6.97	6.80	6.63	6.47	6.30
5.0	2.8	7.95	7.76	7.57	7.38	7.20
8.3	6.1	8.16	7.96	7.77	7.57	7.38
10.0	8.3	8.16	7.96	7.77	7.57	7.38
15.0	10.0	8.16	7.96	7.77	7.57	7.38
20.0	15.0	7.78	7.60	7.41	7.23	7.04
23.9	18.3	7.42	7.24	7.06	6.89	6.71

**OUTDOOR UNIT
 AOJ36RLXZFH**

■ Wall mounted type

● Heating capacity in kBtu/h

- TC: Total Capacity (kBtu/h).
- The data is based on the following conditions:
Pipe length: 24.6 ft (7.5 m), Height difference: 0 ft (0 m) [Outdoor unit - Indoor unit]

MODEL: ASU7RLF1

Outdoor temperature		Indoor temperature (°FDB)				
		60.0	65.0	70.0	75.0	78.0
(°FDB)	(°FWB)	TC	TC	TC	TC	TC
5.0	3.0	5.03	4.91	4.79	4.67	4.55
14.0	12.0	5.67	5.54	5.40	5.27	5.13
23.0	19.0	6.31	6.16	6.01	5.86	5.71
32.0	28.0	7.35	7.18	7.00	6.83	6.65
41.0	37.0	8.40	8.20	8.00	7.80	7.60
47.0	43.0	8.61	8.41	8.20	8.00	7.79
50.0	47.0	8.61	8.41	8.20	8.00	7.79
59.0	50.0	8.61	8.41	8.20	8.00	7.79
68.0	59.0	8.22	8.02	7.83	7.63	7.43
75.0	65.0	7.83	7.65	7.46	7.27	7.09

MODEL: ASU9RLF1

Outdoor temperature		Indoor temperature (°FDB)				
		60.0	65.0	70.0	75.0	78.0
(°FDB)	(°FWB)	TC	TC	TC	TC	TC
5.0	3.0	6.44	6.29	6.13	5.98	5.83
14.0	12.0	7.26	7.09	6.92	6.74	6.57
23.0	19.0	8.08	7.89	7.70	7.51	7.31
32.0	28.0	9.42	9.19	8.97	8.74	8.52
41.0	37.0	10.75	10.50	10.24	9.98	9.73
47.0	43.0	11.03	10.76	10.50	10.24	9.98
50.0	47.0	11.03	10.76	10.50	10.24	9.98
59.0	50.0	11.03	10.76	10.50	10.24	9.98
68.0	59.0	10.52	10.27	10.02	9.77	9.52
75.0	65.0	10.03	9.79	9.55	9.31	9.07

MODEL: ASU12RLF1

Outdoor temperature		Indoor temperature (°FDB)				
		60.0	65.0	70.0	75.0	78.0
(°FDB)	(°FWB)	TC	TC	TC	TC	TC
5.0	3.0	8.59	8.38	8.18	7.97	7.77
14.0	12.0	9.68	9.45	9.22	8.99	8.76
23.0	19.0	10.78	10.52	10.26	10.01	9.75
32.0	28.0	12.56	12.26	11.96	11.66	11.36
41.0	37.0	14.33	13.99	13.65	13.31	12.97
47.0	43.0	14.70	14.35	14.00	13.65	13.30
50.0	47.0	14.70	14.35	14.00	13.65	13.30
59.0	50.0	14.70	14.35	14.00	13.65	13.30
68.0	59.0	14.03	13.69	13.36	13.03	12.69
75.0	65.0	13.37	13.05	12.74	12.42	12.10

MODEL: ASU15RLF1

Outdoor temperature		Indoor temperature (°FDB)				
		60.0	65.0	70.0	75.0	78.0
(°FDB)	(°FWB)	TC	TC	TC	TC	TC
5.0	3.0	10.73	10.48	10.22	9.97	9.71
14.0	12.0	12.10	11.81	11.53	11.24	10.95
23.0	19.0	13.47	13.15	12.83	12.51	12.19
32.0	28.0	15.69	15.32	14.95	14.57	14.20
41.0	37.0	17.92	17.49	17.07	16.64	16.21
47.0	43.0	18.38	17.94	17.50	17.06	16.63
50.0	47.0	18.38	17.94	17.50	17.06	16.63
59.0	50.0	18.38	17.94	17.50	17.06	16.63
68.0	59.0	17.54	17.12	16.70	16.28	15.87
75.0	65.0	16.71	16.32	15.92	15.52	15.12

MODEL: ASU18RLF

Outdoor temperature		Indoor temperature (°FDB)				
		60.0	65.0	70.0	75.0	78.0
(°FDB)	(°FWB)	TC	TC	TC	TC	TC
5.0	3.0	12.88	12.57	12.27	11.96	11.65
14.0	12.0	14.52	14.18	13.83	13.48	13.14
23.0	19.0	16.17	15.78	15.40	15.01	14.63
32.0	28.0	18.83	18.39	17.94	17.49	17.04
41.0	37.0	21.50	20.99	20.48	19.97	19.45
47.0	43.0	22.05	21.53	21.00	20.48	19.95
50.0	47.0	22.05	21.53	21.00	20.48	19.95
59.0	50.0	22.05	21.53	21.00	20.48	19.95
68.0	59.0	21.04	20.54	20.04	19.54	19.04
75.0	65.0	20.06	19.58	19.10	18.63	18.15

MODEL: ASU24RLF

Outdoor temperature		Indoor temperature (°FDB)				
		60.0	65.0	70.0	75.0	78.0
(°FDB)	(°FWB)	TC	TC	TC	TC	TC
5.0	3.0	16.25	15.87	15.48	15.09	14.70
14.0	12.0	18.33	17.89	17.45	17.02	16.58
23.0	19.0	20.40	19.91	19.43	18.94	18.46
32.0	28.0	23.77	23.20	22.63	22.07	21.50
41.0	37.0	27.13	26.49	25.84	25.20	24.55
47.0	43.0	27.83	27.16	26.50	25.84	25.18
50.0	47.0	27.83	27.16	26.50	25.84	25.18
59.0	50.0	27.83	27.16	26.50	25.84	25.18
68.0	59.0	26.55	25.92	25.29	24.66	24.03
75.0	65.0	25.31	24.71	24.11	23.50	22.90

● Heating capacity in kW

- TC: Total Capacity (kW).
- The data is based on the following conditions:
Pipe length: 24.6 ft (7.5 m), Height difference: 0 ft (0 m) [Outdoor unit - Indoor unit]

MODEL: ASU7RLF1

Outdoor temperature		Indoor temperature (°CDB)				
		15.6	18.3	21.1	23.9	25.6
(°CDB)	(°CWB)	TC	TC	TC	TC	TC
-15.0	-16.1	1.47	1.44	1.40	1.37	1.33
-10.0	-11.1	1.66	1.62	1.58	1.54	1.50
-5.0	-7.2	1.85	1.81	1.76	1.72	1.67
0.0	-2.2	2.16	2.10	2.05	2.00	1.95
5.0	2.8	2.46	2.40	2.34	2.29	2.23
8.3	6.1	2.52	2.46	2.40	2.34	2.28
10.0	8.3	2.52	2.46	2.40	2.34	2.28
15.0	10.0	2.52	2.46	2.40	2.34	2.28
20.0	15.0	2.41	2.35	2.29	2.24	2.18
23.9	18.3	2.30	2.24	2.19	2.13	2.08

MODEL: ASU9RLF1

Outdoor temperature		Indoor temperature (°CDB)				
		15.6	18.3	21.1	23.9	25.6
(°CDB)	(°CWB)	TC	TC	TC	TC	TC
-15.0	-16.1	1.89	1.84	1.80	1.75	1.71
-10.0	-11.1	2.13	2.08	2.03	1.98	1.93
-5.0	-7.2	2.37	2.31	2.26	2.20	2.14
0.0	-2.2	2.76	2.69	2.63	2.56	2.50
5.0	2.8	3.15	3.08	3.00	2.93	2.85
8.3	6.1	3.23	3.15	3.08	3.00	2.92
10.0	8.3	3.23	3.15	3.08	3.00	2.92
15.0	10.0	3.23	3.15	3.08	3.00	2.92
20.0	15.0	3.08	3.01	2.94	2.86	2.79
23.9	18.3	2.94	2.87	2.80	2.73	2.66

MODEL: ASU12RLF1

Outdoor temperature		Indoor temperature (°CDB)				
		15.6	18.3	21.1	23.9	25.6
(°CDB)	(°CWB)	TC	TC	TC	TC	TC
-15.0	-16.1	2.52	2.46	2.40	2.34	2.28
-10.0	-11.1	2.84	2.77	2.70	2.63	2.57
-5.0	-7.2	3.16	3.08	3.01	2.93	2.86
0.0	-2.2	3.68	3.59	3.50	3.42	3.33
5.0	2.8	4.20	4.10	4.00	3.90	3.80
8.3	6.1	4.31	4.21	4.10	4.00	3.90
10.0	8.3	4.31	4.21	4.10	4.00	3.90
15.0	10.0	4.31	4.21	4.10	4.00	3.90
20.0	15.0	4.11	4.01	3.92	3.82	3.72
23.9	18.3	3.92	3.83	3.73	3.64	3.55

MODEL: ASU15RLF1

Outdoor temperature		Indoor temperature (°CDB)				
		15.6	18.3	21.1	23.9	25.6
(°CDB)	(°CWB)	TC	TC	TC	TC	TC
-15.0	-16.1	3.15	3.07	3.00	2.92	2.85
-10.0	-11.1	3.55	3.46	3.38	3.29	3.21
-5.0	-7.2	3.95	3.85	3.76	3.67	3.57
0.0	-2.2	4.60	4.49	4.38	4.27	4.16
5.0	2.8	5.25	5.13	5.00	4.88	4.75
8.3	6.1	5.39	5.26	5.13	5.00	4.87
10.0	8.3	5.39	5.26	5.13	5.00	4.87
15.0	10.0	5.39	5.26	5.13	5.00	4.87
20.0	15.0	5.14	5.02	4.89	4.77	4.65
23.9	18.3	4.90	4.78	4.67	4.55	4.43

MODEL: ASU18RLF

Outdoor temperature		Indoor temperature (°CDB)				
		15.6	18.3	21.1	23.9	25.6
(°CDB)	(°CWB)	TC	TC	TC	TC	TC
-15.0	-16.1	3.77	3.68	3.59	3.51	3.42
-10.0	-11.1	4.26	4.15	4.05	3.95	3.85
-5.0	-7.2	4.74	4.63	4.51	4.40	4.29
0.0	-2.2	5.52	5.39	5.26	5.13	4.99
5.0	2.8	6.30	6.15	6.00	5.85	5.70
8.3	6.1	6.46	6.31	6.15	6.00	5.85
10.0	8.3	6.46	6.31	6.15	6.00	5.85
15.0	10.0	6.46	6.31	6.15	6.00	5.85
20.0	15.0	6.17	6.02	5.87	5.73	5.58
23.9	18.3	5.88	5.74	5.60	5.46	5.32

MODEL: ASU24RLF

Outdoor temperature		Indoor temperature (°CDB)				
		15.6	18.3	21.1	23.9	25.6
(°CDB)	(°CWB)	TC	TC	TC	TC	TC
-15.0	-16.1	4.76	4.65	4.54	4.42	4.31
-10.0	-11.1	5.37	5.24	5.12	4.99	4.86
-5.0	-7.2	5.98	5.84	5.69	5.55	5.41
0.0	-2.2	6.97	6.80	6.63	6.47	6.30
5.0	2.8	7.95	7.76	7.57	7.38	7.20
8.3	6.1	8.16	7.96	7.77	7.57	7.38
10.0	8.3	8.16	7.96	7.77	7.57	7.38
15.0	10.0	8.16	7.96	7.77	7.57	7.38
20.0	15.0	7.78	7.60	7.41	7.23	7.04
23.9	18.3	7.42	7.24	7.06	6.89	6.71

**OUTDOOR UNIT
 AOJ36RLXFZH**

■ Floor type

● Heating capacity in kBtu/h

- TC: Total Capacity (kBtu/h).
- The data is based on the following conditions:
Pipe length: 24.6 ft (7.5 m), Height difference: 0 ft (0 m) [Outdoor unit - Indoor unit]

MODEL: AGU9RLF

Outdoor temperature		Indoor temperature (°FDB)				
		60.0	65.0	70.0	75.0	78.0
(°FDB)	(°FWB)	TC	TC	TC	TC	TC
5.0	3.0	6.44	6.29	6.13	5.98	5.83
14.0	12.0	7.26	7.09	6.92	6.74	6.57
23.0	19.0	8.08	7.89	7.70	7.51	7.31
32.0	28.0	9.42	9.19	8.97	8.74	8.52
41.0	37.0	10.75	10.50	10.24	9.98	9.73
47.0	43.0	11.03	10.76	10.50	10.24	9.98
50.0	47.0	11.03	10.76	10.50	10.24	9.98
59.0	50.0	11.03	10.76	10.50	10.24	9.98
68.0	59.0	10.52	10.27	10.02	9.77	9.52
75.0	65.0	10.03	9.79	9.55	9.31	9.07

MODEL: AGU12RLF

Outdoor temperature		Indoor temperature (°FDB)				
		60.0	65.0	70.0	75.0	78.0
(°FDB)	(°FWB)	TC	TC	TC	TC	TC
5.0	3.0	8.59	8.38	8.18	7.97	7.77
14.0	12.0	9.68	9.45	9.22	8.99	8.76
23.0	19.0	10.78	10.52	10.26	10.01	9.75
32.0	28.0	12.56	12.26	11.96	11.66	11.36
41.0	37.0	14.33	13.99	13.65	13.31	12.97
47.0	43.0	14.70	14.35	14.00	13.65	13.30
50.0	47.0	14.70	14.35	14.00	13.65	13.30
59.0	50.0	14.70	14.35	14.00	13.65	13.30
68.0	59.0	14.03	13.69	13.36	13.03	12.69
75.0	65.0	13.37	13.05	12.74	12.42	12.10

MODEL: AGU15RLF

Outdoor temperature		Indoor temperature (°FDB)				
		60.0	65.0	70.0	75.0	78.0
(°FDB)	(°FWB)	TC	TC	TC	TC	TC
5.0	3.0	26.46	25.83	25.20	24.57	23.94
14.0	12.0	28.01	27.34	26.67	26.01	25.34
23.0	19.0	29.56	28.85	28.15	27.45	26.74
32.0	28.0	31.11	30.37	29.63	28.89	28.14
41.0	37.0	32.66	31.88	31.10	30.32	29.55
47.0	43.0	34.21	33.39	32.50	31.76	30.95
50.0	47.0	35.76	34.91	34.06	33.20	32.35
59.0	50.0	37.31	36.42	35.53	34.64	33.76
68.0	59.0	38.86	37.93	37.01	36.08	35.16
75.0	65.0	40.41	39.45	38.49	37.52	36.56

● Heating capacity in kW

- TC: Total Capacity (kW).
- The data is based on the following conditions:
Pipe length: 24.6 ft (7.5 m), Height difference: 0 ft (0 m) [Outdoor unit - Indoor unit]

MODEL: AGU9RLF

Outdoor temperature		Indoor temperature (°CDB)				
		15.6	18.3	21.1	23.9	25.6
(°CDB)	(°CWB)	TC	TC	TC	TC	TC
-15.0	-16.1	1.89	1.84	1.80	1.75	1.71
-10.0	-11.1	2.13	2.08	2.03	1.98	1.93
-5.0	-7.2	2.37	2.31	2.26	2.20	2.14
0.0	-2.2	2.69	2.69	2.63	2.56	2.50
5.0	2.8	3.15	3.08	3.00	2.93	2.85
8.3	6.1	3.23	3.15	3.08	3.00	2.92
10.0	8.3	3.23	3.15	3.08	3.00	2.92
15.0	10.0	3.23	3.15	3.08	3.00	2.92
20.0	15.0	3.08	3.01	2.94	2.86	2.79
23.9	18.3	2.94	2.87	2.80	2.73	2.66

MODEL: AGU12RLF

Outdoor temperature		Indoor temperature (°CDB)				
		15.6	18.3	21.1	23.9	25.6
(°CDB)	(°CWB)	TC	TC	TC	TC	TC
-15.0	-16.1	2.52	2.46	2.40	2.34	2.28
-10.0	-11.1	2.84	2.77	2.70	2.63	2.57
-5.0	-7.2	3.16	3.08	3.01	2.93	2.86
0.0	-2.2	3.68	3.59	3.50	3.42	3.33
5.0	2.8	4.20	4.10	4.00	3.90	3.80
8.3	6.1	4.31	4.21	4.10	4.00	3.90
10.0	8.3	4.31	4.21	4.10	4.00	3.90
15.0	10.0	4.31	4.21	4.10	4.00	3.90
20.0	15.0	4.11	4.01	3.92	3.82	3.72
23.9	18.3	3.92	3.83	3.73	3.64	3.55

MODEL: AGU15RLF

Outdoor temperature		Indoor temperature (°CDB)				
		15.6	18.3	21.1	23.9	25.6
(°CDB)	(°CWB)	TC	TC	TC	TC	TC
-15.0	-16.1	7.75	7.57	7.38	7.20	7.02
-10.0	-11.1	8.21	8.01	7.82	7.62	7.43
-5.0	-7.2	8.66	8.46	8.25	8.04	7.84
0.0	-2.2	9.12	8.90	8.68	8.47	8.25
5.0	2.8	9.57	9.34	9.12	8.89	8.66
8.3	6.1	10.03	9.79	9.53	9.31	9.07
10.0	8.3	10.48	10.23	9.98	9.73	9.48
15.0	10.0	10.93	10.67	10.41	10.15	9.89
20.0	15.0	11.39	11.12	10.85	10.58	10.30
23.9	18.3	11.84	11.56	11.28	11.00	10.72

7. Capacity compensation rate for pipe length and height difference

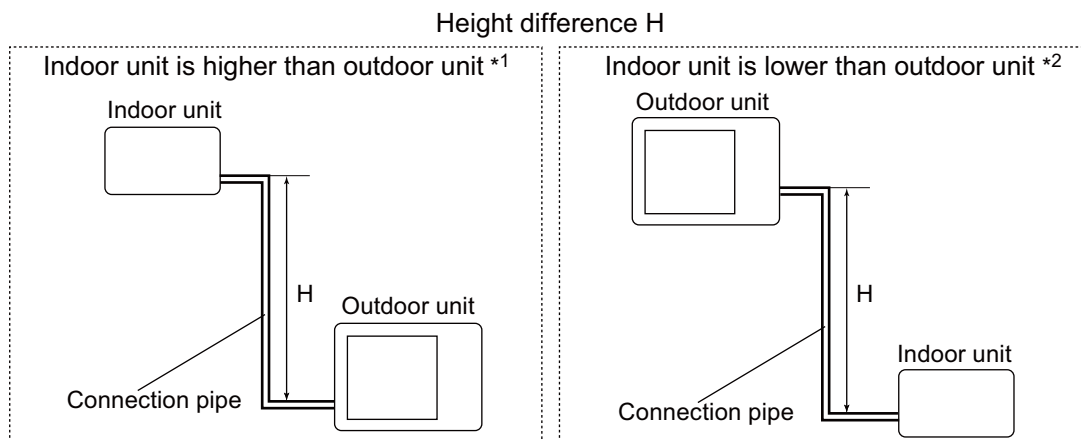

7-1. Model: AOU36RLXFZH

NOTE: Values mentioned in the table are calculated based on the maximum capacity.

■ Indoor unit: 7,000 Btu

COOLING		Pipe length							
			m	5	7.5	10	15	20	25
		m	ft	16	25	33	49	66	82
Height difference H (m)	Indoor unit is higher than outdoor unit *1	15	49	—	—	—	0.955	0.941	0.927
		10	33	—	—	0.976	0.962	0.949	0.935
		7.5	25	—	0.988	0.980	0.966	0.952	0.939
		5	16	0.995	0.992	0.984	0.970	0.956	0.942
		0	0	1.003	1.000	0.992	0.978	0.964	0.950
Height difference H (m)	Indoor unit is lower than outdoor unit *2	-5	-16	1.003	1.000	0.992	0.978	0.964	0.950
		-7.5	-25	—	1.000	0.992	0.978	0.964	0.950
		-10	-33	—	—	0.992	0.978	0.964	0.950
		-15	-49	—	—	—	0.978	0.964	0.950

HEATING		Pipe length							
			m	5	7.5	10	15	20	25
		m	ft	16	25	33	49	66	82
Height difference H (m)	Indoor unit is higher than outdoor unit *1	15	49	—	—	—	0.976	0.957	0.938
		10	33	—	—	0.991	0.976	0.957	0.938
		7.5	25	—	1.000	0.991	0.976	0.957	0.938
		5	16	0.990	1.000	0.991	0.976	0.957	0.938
		0	0	0.990	1.000	0.991	0.976	0.957	0.938
Height difference H (m)	Indoor unit is lower than outdoor unit *2	-5	-16	0.985	0.995	0.986	0.971	0.952	0.933
		-7.5	-25	—	0.993	0.984	0.969	0.950	0.931
		-10	-33	—	—	0.981	0.966	0.947	0.929
		-15	-49	—	—	—	0.961	0.943	0.924

Indoor unit: 9,000 Btu

OUTDOOR UNIT
AOJ36RLXFZH

COOLING		Pipe length							
			m	5	7.5	10	15	20	25
		m	ft	16	25	33	49	66	82
Height difference H (m)	Indoor unit is higher than outdoor unit *1	15	49	—	—	—	0.956	0.942	0.928
		10	33	—	—	0.977	0.963	0.950	0.936
		7.5	25	—	0.988	0.981	0.967	0.954	0.940
		5	16	0.999	0.992	0.985	0.971	0.957	0.943
	Indoor unit is lower than outdoor unit *2	0	0	1.007	1.000	0.993	0.979	0.965	0.951
		-5	-16	1.007	1.000	0.993	0.979	0.965	0.951
		-7.5	-25	—	1.000	0.993	0.979	0.965	0.951
		-10	-33	—	—	0.993	0.979	0.965	0.951
		-15	-49	—	—	—	0.979	0.965	0.951

HEATING		Pipe length							
			m	5	7.5	10	15	20	25
		m	ft	16	25	33	49	66	82
Height difference H (m)	Indoor unit is higher than outdoor unit *1	15	49	—	—	—	0.977	0.958	0.939
		10	33	—	—	0.993	0.977	0.958	0.939
		7.5	25	—	1.000	0.993	0.977	0.958	0.939
		5	16	0.993	1.000	0.993	0.977	0.958	0.939
	Indoor unit is lower than outdoor unit *2	0	0	0.993	1.000	0.993	0.977	0.958	0.939
		-5	-16	0.988	0.995	0.988	0.972	0.954	0.934
		-7.5	-25	—	0.993	0.986	0.970	0.952	0.932
		-10	-33	—	—	0.983	0.967	0.949	0.930
		-15	-49	—	—	—	0.962	0.944	0.925

Indoor unit: 12,000 Btu

COOLING		Pipe length							
			m	5	7.5	10	15	20	25
		m	ft	16	25	33	49	66	82
Height difference H (m)	Indoor unit is higher than outdoor unit *1	15	49	—	—	—	0.937	0.912	0.888
		10	33	—	—	0.970	0.944	0.919	0.896
		7.5	25	—	0.988	0.974	0.948	0.923	0.899
		5	16	1.006	0.992	0.978	0.952	0.927	0.903
	Indoor unit is lower than outdoor unit *2	0	0	1.014	1.000	0.986	0.960	0.934	0.910
		-5	-16	1.014	1.000	0.986	0.960	0.934	0.910
		-7.5	-25	—	1.000	0.986	0.960	0.934	0.910
		-10	-33	—	—	0.986	0.960	0.934	0.910
		-15	-49	—	—	—	0.960	0.934	0.910

HEATING		Pipe length							
			m	5	7.5	10	15	20	25
		m	ft	16	25	33	49	66	82
Height difference H (m)	Indoor unit is higher than outdoor unit *1	15	49	—	—	—	0.977	0.958	0.938
		10	33	—	—	0.993	0.977	0.958	0.938
		7.5	25	—	1.000	0.993	0.977	0.958	0.938
		5	16	0.995	1.000	0.993	0.977	0.958	0.938
	Indoor unit is lower than outdoor unit *2	0	0	0.995	1.000	0.993	0.977	0.958	0.938
		-5	-16	0.990	0.995	0.988	0.972	0.953	0.933
		-7.5	-25	—	0.993	0.986	0.970	0.952	0.932
		-10	-33	—	—	0.983	0.967	0.949	0.929
		-15	-49	—	—	—	0.962	0.944	0.924

■ Indoor unit: 14,000 Btu

COOLING		Pipe length							
			m	5	7.5	10	15	20	25
		m	ft	16	25	33	49	66	82
Height difference H (m)	Indoor unit is higher than outdoor unit *1	15	49	—	—	—	0.955	0.937	0.922
		10	33	—	—	0.974	0.962	0.945	0.930
		7.5	25	—	0.988	0.978	0.966	0.948	0.934
		5	16	0.997	0.992	0.982	0.970	0.952	0.937
	Indoor unit is lower than outdoor unit *2	0	0	1.005	1.000	0.990	0.978	0.960	0.945
		-5	-16	1.005	1.000	0.990	0.978	0.960	0.945
		-7.5	-25	—	1.000	0.990	0.978	0.960	0.945
		-10	-33	—	—	0.990	0.978	0.960	0.945
		-15	-49	—	—	—	0.978	0.960	0.945

HEATING		Pipe length							
			m	5	7.5	10	15	20	25
		m	ft	16	25	33	49	66	82
Height difference H (m)	Indoor unit is higher than outdoor unit *1	15	49	—	—	—	0.972	0.945	0.919
		10	33	—	—	0.992	0.972	0.945	0.919
		7.5	25	—	1.000	0.992	0.972	0.945	0.919
		5	16	1.000	1.000	0.992	0.972	0.945	0.919
	Indoor unit is lower than outdoor unit *2	0	0	1.000	1.000	0.992	0.972	0.945	0.919
		-5	-16	0.995	0.995	0.987	0.967	0.940	0.914
		-7.5	-25	—	0.993	0.985	0.965	0.938	0.912
		-10	-33	—	—	0.982	0.962	0.935	0.910
		-15	-49	—	—	—	0.957	0.930	0.905

■ Indoor unit: 18,000 Btu

COOLING		Pipe length							
			m	5	7.5	10	15	20	25
		m	ft	16	25	33	49	66	82
Height difference H (m)	Indoor unit is higher than outdoor unit *1	15	49	—	—	—	0.968	0.961	0.954
		10	33	—	—	0.982	0.976	0.969	0.962
		7.5	25	—	0.988	0.986	0.980	0.973	0.966
		5	16	0.994	0.992	0.990	0.984	0.977	0.970
	Indoor unit is lower than outdoor unit *2	0	0	1.002	1.000	0.998	0.992	0.985	0.978
		-5	-16	1.002	1.000	0.998	0.992	0.985	0.978
		-7.5	-25	—	1.000	0.998	0.992	0.985	0.978
		-10	-33	—	—	0.998	0.992	0.985	0.978
		-15	-49	—	—	—	0.992	0.985	0.978

HEATING		Pipe length							
			m	5	7.5	10	15	20	25
		m	ft	16	25	33	49	66	82
Height difference H (m)	Indoor unit is higher than outdoor unit *1	15	49	—	—	—	0.967	0.943	0.917
		10	33	—	—	0.990	0.967	0.943	0.917
		7.5	25	—	1.000	0.990	0.967	0.943	0.917
		5	16	1.010	1.000	0.990	0.967	0.943	0.917
	Indoor unit is lower than outdoor unit *2	0	0	1.010	1.000	0.990	0.967	0.943	0.917
		-5	-16	1.005	0.995	0.985	0.962	0.938	0.912
		-7.5	-25	—	0.993	0.983	0.960	0.936	0.910
		-10	-33	—	—	0.980	0.958	0.933	0.908
		-15	-49	—	—	—	0.953	0.929	0.903

■ Indoor unit: 24,000 Btu

OUTDOOR UNIT
AOU36RLXZFH

COOLING		Pipe length							
			m	5	7.5	10	15	20	25
		m	ft	16	25	33	49	66	82
Height difference H (m)	Indoor unit is higher than outdoor unit *1	15	49	—	—	—	0.978	0.969	0.953
		10	33	—	—	0.986	0.986	0.977	0.961
		7.5	25	—	0.988	0.990	0.990	0.981	0.965
		5	16	0.989	0.992	0.994	0.994	0.984	0.968
		0	0	0.997	1.000	1.002	1.002	0.992	0.976
	Indoor unit is lower than outdoor unit *2	-5	-16	0.997	1.000	1.002	1.002	0.992	0.976
		-7.5	-25	—	1.000	1.002	1.002	0.992	0.976
		-10	-33	—	—	1.002	1.002	0.992	0.976
-15		-49	—	—	—	1.002	0.992	0.976	

HEATING		Pipe length							
			m	5	7.5	10	15	20	25
		m	ft	16	25	33	49	66	82
Height difference H (m)	Indoor unit is higher than outdoor unit *1	15	49	—	—	—	0.964	0.939	0.913
		10	33	—	—	0.988	0.964	0.939	0.913
		7.5	25	—	1.000	0.988	0.964	0.939	0.913
		5	16	1.008	1.000	0.988	0.964	0.939	0.913
		0	0	1.008	1.000	0.988	0.964	0.939	0.913
	Indoor unit is lower than outdoor unit *2	-5	-16	1.003	0.995	0.983	0.959	0.934	0.909
		-7.5	-25	—	0.993	0.981	0.957	0.932	0.907
		-10	-33	—	—	0.978	0.954	0.929	0.904
-15		-49	—	—	—	0.949	0.925	0.899	

8. Additional charge calculation

8-1. Model: AOU36RLXFZH

Refrigerant type		R410A
Refrigerant amount	lb oz	8 lb 13 oz
	g	4,000

■ Refrigerant charge

Total pipe length	ft (m)	164 (50) or less	197 (60)	230 (70) (Max.)	0.22 oz/ft (20 g/m)
Additional charge	lb oz (g)	0	7.1 oz (200)	14.1 oz (400)	

9. Airflow

9-1. Model: AOU36RLXFZH

● Cooling

m ³ /h	4,200
l/s	1,167
CFM	2,472

● Heating

m ³ /h	4,200
l/s	1,167
CFM	2,472

10. Operation noise (sound pressure)

10-1. Noise level curve

■ Model: AOU36RLXFZH

● Cooling

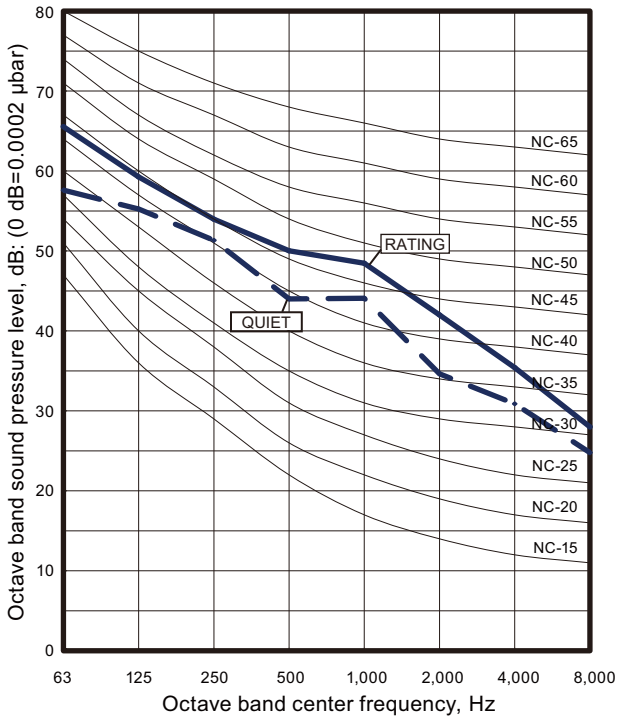

● Heating

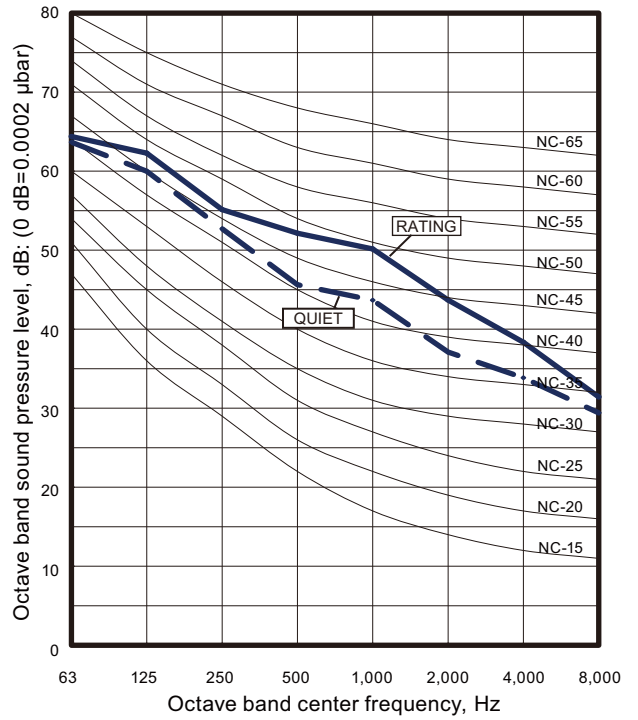

OUTDOOR UNIT
AOU36RLXFZH

10-2. Sound level check point

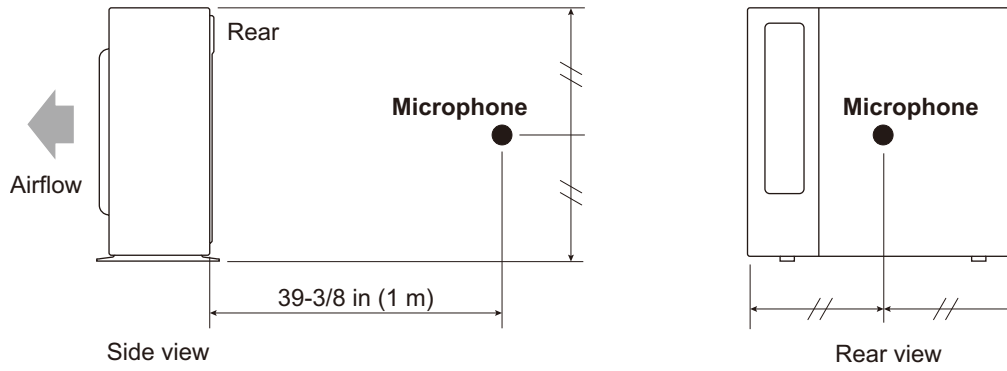

NOTE: Detailed shape of the actual outdoor unit might be slightly different from the one illustrated above.

11. Electrical characteristics

Model name			AOU36RLXFZH
Power supply	Voltage	V	208/230 ~
	Frequency	Hz	60
MCA		A	31.5
Starting current		A	12.9
Wiring spec. *	CKT. BKR	A	40
	Power cable	AWG	8

*: Selected sample based on Japan Electrotechnical Standards and Codes Committee E0005. As the regulations of wire size and circuit breaker differ in each country or region, select appropriate devices complied to the regional standard.

MCA: Minimum Circuit Ampacity (Calculation based on UL1995)

CKT. BKR: Circuit Breaker

12. Safety devices

Type of protection	Protection form		Model
			AOU36RLXFZH
Circuit protection	Current fuse (PCB)		250 V, 10 A 250 V, 5 A 400 V, 5 A 250 V, 3.15 A
	Protector (PCB)		500 V, 45 A
Fan motor protection	Thermal protection program	Activate	239 ± 2 °F (115 ± 15 °C) Fan motor stop
		Reset	158 °F (70 °C) Fan motor restart
Compressor protection	Thermal protection program (Compressor temp.)	Activate	226 °F (108 °C) Compressor stop
		Reset	176 °F (80 °C) Compressor restart
	Thermal protection program (Discharge temp.)	Activate	230 °F (110 °C) Compressor stop
		Reset	After 3 minutes and 230 °F (110 °C) less than Compressor restart

13. Function settings

13-1. Setting methods

⚠ WARNING

Never touch electrical components such as the terminal blocks or reactor except the switch on the display board. It may cause a serious accident such as electric shock.

⚠ CAUTION

- Once refrigerant charging is completed, be sure to open the valve prior to performing the local settings. Otherwise, the compressor may fail.
- Discharge any static electricity from your body before touching the push switches. Never touch any terminal or pattern of any parts on the control board.

The positions of the switches on the outdoor unit control board are shown in the figure below.

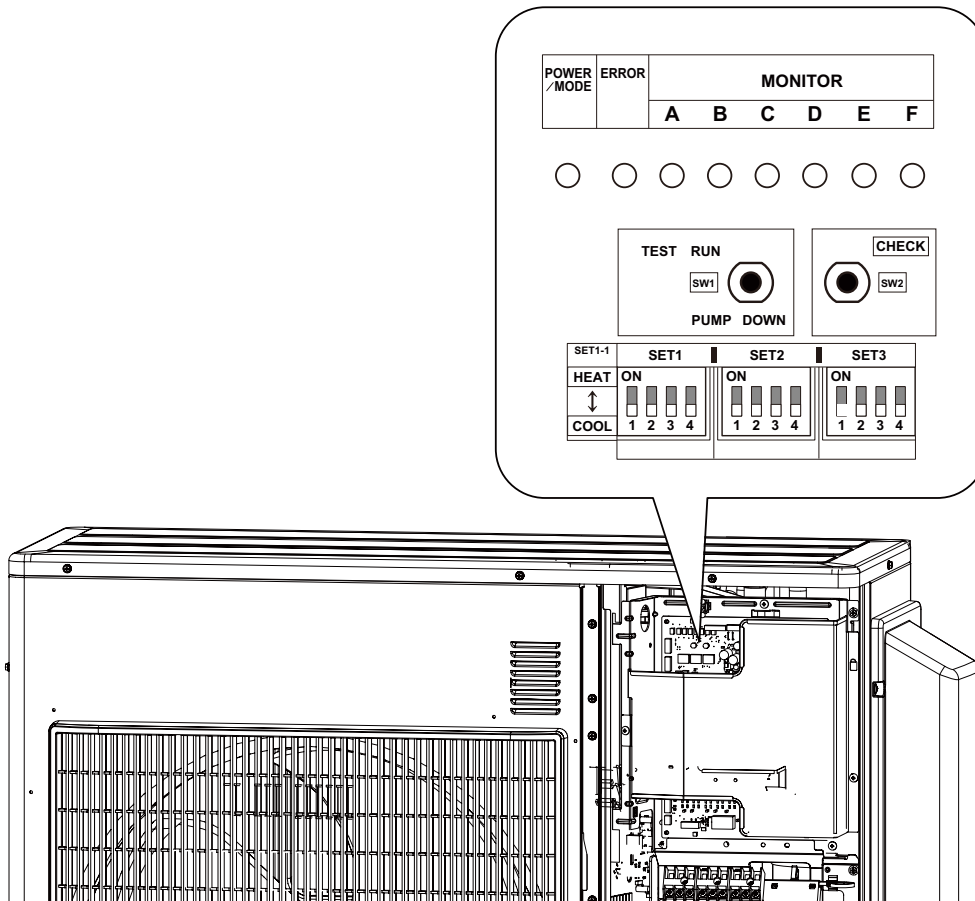

Setting method

1. Be sure to disconnect the power supply or turn off the breaker.
2. Change the DIP switch setting according to the required setting.
 - Various settings can be adjusted by changing DIP switches and push switches on the board of the outdoor unit.
 - The printed characters for the LED display are shown below.

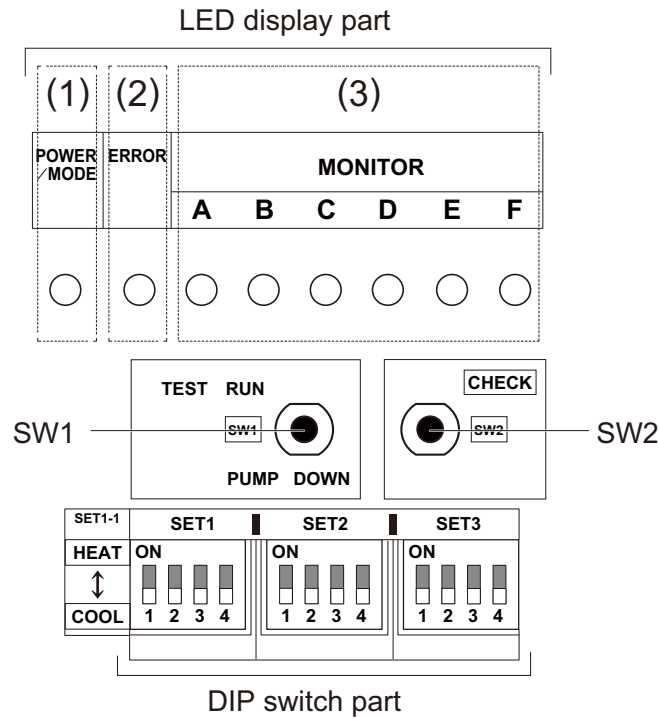

Description of display

LED display lamp			Function or operation method
(1)	POWER/MODE	Green	<ul style="list-style-type: none"> • Turns on when the power supply is ON (Including when error occurs). • Indicate the MODE by the number of flashes when the installation function is active.
(2)	ERROR	Red	Flashes at high-speed when there is an error.
(3)	MONITOR	A	<ul style="list-style-type: none"> • Displays the location and contents of errors when there is an error. (Refer to Chapter 14-3. "Error code" on page 245 for details.) • Displays when check run is activated. (Refer to Chapter 14-1. "Check run" on page 237 for details.)
		B	
		C	
		D	
		E	
		F	

Switch		Function or operation method	Factory setting
SW1	Push	<ul style="list-style-type: none"> For the test run start and stop. For the pump down start and stop. 	—
SW2	Push	<ul style="list-style-type: none"> For when check run function is activated. For displaying the check run. For resetting the Automatic wiring correction memory. 	—
SET1-1	DIP	For selecting cooling or heating during test operation.	OFF
SET1-2	DIP	For switching SW1 operation.	OFF
SET1-3	DIP	For switching the base heater. (For extra cold climate area model only)	ON
SET1-4	DIP	(Prohibited)	OFF (Do not change)
SET2-1	DIP	<ul style="list-style-type: none"> For selecting outdoor unit low noise operation function. To use this function, the Central remote controller (option) is necessary. 	OFF
SET2-2	DIP	(Prohibited)	OFF (Do not change)
SET2-3	DIP	(Prohibited)	OFF (Do not change)
SET2-4	DIP	(Prohibited)	OFF (Do not change)
SET3-1	DIP	(Prohibited)	OFF (Do not change)
SET3-2	DIP	(Prohibited)	OFF (Do not change)
SET3-3	DIP	(Prohibited)	OFF (Do not change)
SET3-4	DIP	(Prohibited)	OFF (Do not change)

Be sure to disconnect the power supply or turn off the breaker before changing the DIP switch setting.

13-2. Base heater forced off function

The power to the base heater can be cut off by changing the DIP switch setting.

SET1-3	Setting
ON	Heater on
OFF	Forced off setting

13-3. Outdoor unit low noise operation function (option)

Change the outdoor unit low noise operation by using this setting. Optional Central remote controller is necessary to use this function.

SET2-1	Setting
ON	Lower
OFF	Low

CAUTION

- When the low noise operation function is working, cooling and heating capacity will decrease.
- When changing the settings, explain to the customer beforehand that the capacity decreases.

14. Check and test

14-1. Check run

- The check run is a function to screen and detect any wiring errors.
- After carrying out the check run, you can use the automatic wiring correction function to correct the wiring.
- Normal operation is possible without using the check run. In this case, use the test run or forced cooling function of the indoor unit to confirm any wiring errors.

■ Things to confirm before starting the check run

To ensure safety, check that the following work, inspections and operations have been completed.

	Check Item	Check Column
1	Check that all work on the piping connecting the outdoor unit, indoor units has been completed.	
2	Check that all work on the wiring connecting the outdoor unit, indoor units has been completed.	
3	Is there a gas leakage? (At pipe connections [flange connections and brazed areas])	
4	Is the system charged with the specified volume of refrigerant?	
5	Is a breaker installed at the power supply cable of outdoor unit?	
6	Are the wires connected to the terminals without looseness, and in accordance with the specifications?	
7	Is the 3-way valve of the outdoor unit open? (Gas pipe and liquid pipe)	
8	Is the power supply connected for more than 12 hours?	

■ Restrictions applicable when performing the check run

- When the check run starts, all indoor units connected to the outdoor unit will start to run automatically. During the check run, you cannot check the operation of the indoor units separately. After the check run, check the operation of the indoor units separately in normal operation.
- The check run can be used when the temperature is within the operable temperature of the air conditioner.
- In the check run, the air conditioner will automatically switch between cooling and heating depending on the external temperature and internal temperature.
- The check run can be completed in about 30 minutes (cooling) or about 1 hour (heating), but may take more depending on the external and internal temperature conditions etc.
- Do not conduct the check run with all the windows in the room closed. Otherwise the room temperature could get too low or too high.
- Depending on the difference of the room temperature of each room, a judgment may be impossible.
- Check run is a special operation so there may be a noise louder than the normal refrigerant noise or a creaking noise.

Operating procedure for check run

CAUTION

Initiate check run after more than 12 hours after the power supply is connected.

NOTE: Be sure that the indoor unit and outdoor unit are not operating before starting the check run.

1. Press the "CHECK" switch for 3 seconds or more.

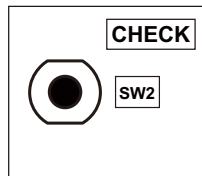

2. The number of indoor units (and the places) connected through the communication lines is displayed.

- If the displayed number of units (places) and the installed number of units (places) is the same, proceed to step 3.
- If the displayed number of units (places) and the installed number of units (places) is not the same, shut off the power and check whether the indoor and outdoor communication lines are properly connected.
- If there is no operation for 1 minute, the LED will return to the original display. (POWER/MODE LED: ON)

Example: When 4 indoor units (A to D) are connected

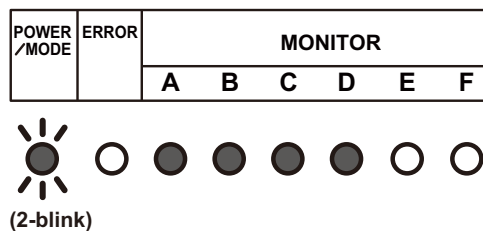

3. Press the "CHECK" switch for 3 seconds or more again. Check run is initiated.

- When check run is initiated, all LEDs from A to F will flash. (Preliminary operation)
- The LED for each indoor unit will switch off in order as check for each unit is completed.

NOTE: To interrupt the check run, press the "CHECK" switch.

Example: When 4 indoor units (A to D) are connected

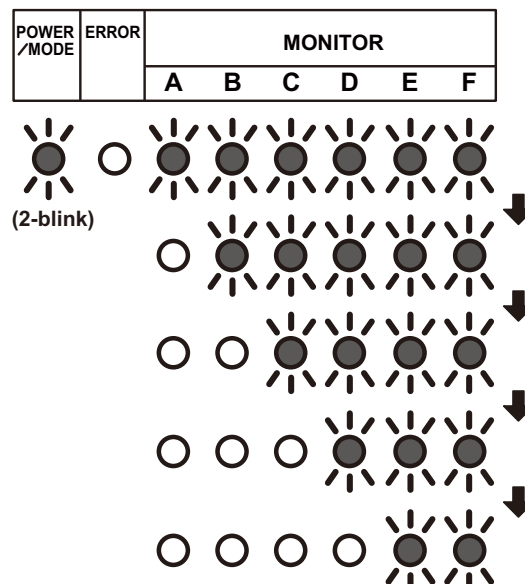

4. After the check run is completed, results will be displayed. Fill the displayed results in the result table accordingly.

- **If the connection is correct (Example: When 4 indoor units are connected)**

After the number of connected units are displayed, the LED for each unit will light up in order from A to D.

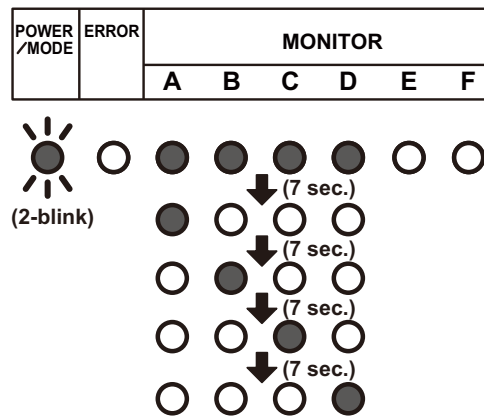

- **If the connection is incorrect (Example: When connection of B and C of the 4 units are reversed)**

After the number of connected units are displayed, B and C will light up in reverse.

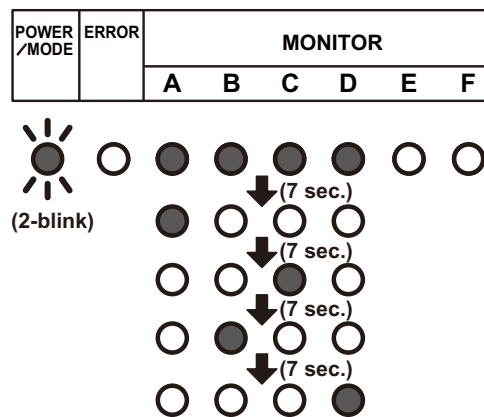

NOTES:

- Automatic wiring correction will not be completed if the power supply is disconnected while displaying the results. To confirm the automatic wiring correction, be sure to carry out step 5.
- If frost is formed on the outdoor unit while displaying the results, automatic defrost function will be operated. Proceed to step 5 after the defrost function is finished.

[How to record the contents]

- Fill the displayed results according to the following example.
- Example: When piping A to D is connected but the wires for B and C are connected in reverse.
<Displayed results>
The LEDs will light up in 7 second intervals in the following order.

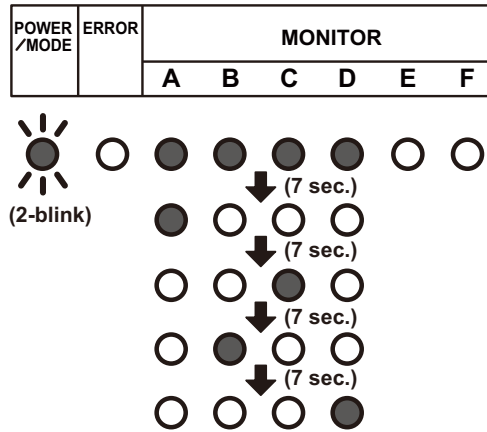

<Example of result table>

- a. Please write a ● where the LEDs light up in the order that they light up.

	A	B	C	D	E	F
1	●	●	●	●	○	○
2	●	○	○	○	○	○
3	○	○	●	○	○	○
4	○	●	○	○	○	○
5	○	○	○	●	○	○
6	○	○	○	○	○	○
7	○	○	○	○	○	○

- b. Based on the results of step (a), please record as follows.

- Trace the dotted circle with a pen if multiple places light up.

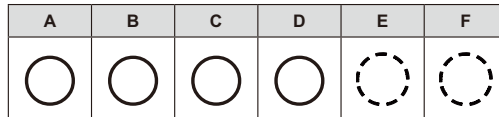

- Write the order from A to D in which the LEDs lit up inside the circle.

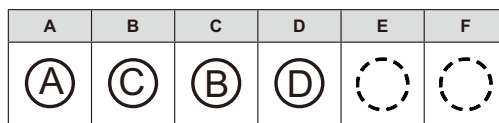

- c. Select the correction method.

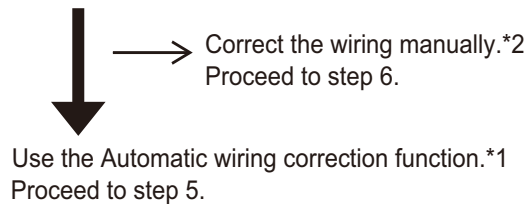

Write down the same results in the label on the reverse side of the service panel.
The results recorded are needed at the time of servicing.

NOTES:







*1: By using this function, the wiring is automatically corrected according to the piping.

*2: When correcting the wiring manually, please disconnect the power supply or turn off the breaker during results display, and then change the wiring manually according to the obtained test results.

For example, in Example 1, the wirings connected to the terminals B and C is to be exchanged manually.

<Result Table>

	A	B	C	D	E	F
1	○	○	○	○	○	○
2	○	○	○	○	○	○
3	○	○	○	○	○	○
4	○	○	○	○	○	○
5	○	○	○	○	○	○
6	○	○	○	○	○	○
7	○	○	○	○	○	○

A	B	C	D	E	F
					

5. During results display, press the "CHECK" switch for 3 seconds or more.

After LEDs A to F have lit in turn, all LEDs will light up indicating that the automatic wiring correction is completed.

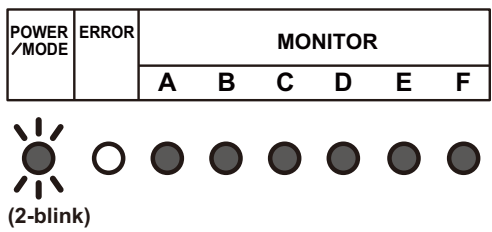

6. Disconnect the power supply or turn off the breaker and wait 10 minutes then turn the power back on and perform test run.

NOTE: If you do not disconnect the power supply or turn off the breaker, normal operation is not possible.

Notices:

- If an error occurs during check run it will be suspended. Correct the error and start check run again.
- After the check run, if automatic wiring correction is carried out, the indoor unit's position will be modified to match the piping. (Note that the display of the optional remote controller changes.)
- If you start check run again after the automatic wiring correction is finished, the modification will be reset.

■ Check run judgment failure display

If check run cannot be performed, the following is displayed. In this case, the check run will stop. Please check by using the cooling test run of the indoor unit.

● Temperature out of range judgment

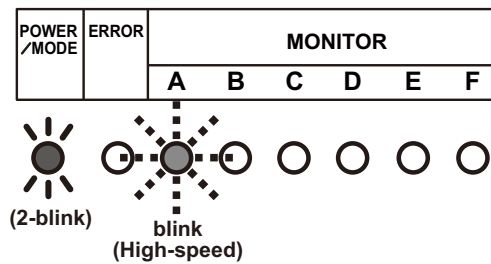

● Wiring/piping number difference

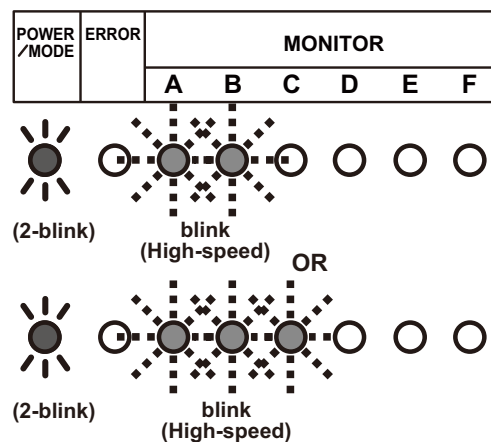

■ Re-display check run results

- If you wish to check the automatic wiring correction contents, by briefly pressing the "CHECK" switch, the check run results is displayed. Check the check run results by referring to the result table in step (4) of "Chapter 14-1. ["Operating procedure for check run"](#) on page 238".
- If the automatic wiring correction contents has not been done, the POWER/MODE LED will blink twice and the MONITOR LED will turn off.

■ Automatic wiring correction memory reset

⚠ CAUTION

When relocating the unit, reset the memory beforehand, or the unit may not function normally.

1. Press the "CHECK" switch.
The LED will light as shown in ["Re-display check run results"](#) on page 242".
2. Press the "CHECK" switch for more than 3 seconds when the LED is on.
3. The LEDs from A to F will light in sequence, and then all LEDs will light to indicate the completion of the Automatic wiring correction memory reset.
4. Disconnect the power supply or turn off the breaker.

14-2. Test run

CAUTION

Always connect the power supply 12 hours prior to the start of the operation in order to protect the compressor.

1. Indoor unit
 - a. Is the drain normal?
 - b. Is there any abnormal noise and vibration during operation?
2. Outdoor unit
 - a. Is there any abnormal noise and vibration during operation?
 - b. Will noise, wind, or drain water from the unit disturb the neighbors?
 - c. Is there any gas leakage?
 - Do not operate the air conditioner in the test running state for a long time.
 - For the operation method of the test run for indoor unit and central remote controller, refer to the operating manual and perform operation check.

■ Test run method

Be sure to temporarily disconnect the power supply or turn off the breaker before changing the DIP switch settings.

1. Check the 3-way valves (both at the liquid side and gas side) are opened. Confirm that the DIP switch SET1-2 is switched off.
2. Set the operation mode to "COOL" or "HEAT". When switching the DIP switch SET1-1 between HEAT and COOL, disconnect the power supply or turn off the circuit breaker beforehand.

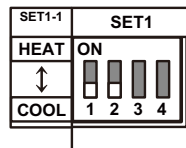

- In the first test run, be sure to set the operation mode to "COOL".
 - The operation mode cannot be switched between "COOL" and "HEAT" during the test run. To switch the operation mode between "COOL" and "HEAT", stop the test run, switch the operation mode, and then start the test run again.
3. Press "TEST RUN" switch for more than 3 seconds.
The POWER / MODE LED flashes once.

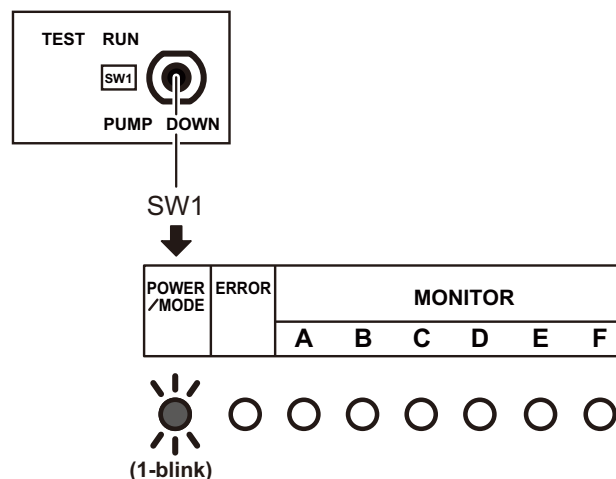

4. Confirm operating status.

5. Press "TEST RUN" switch for more than 3 seconds.

POWER /MODE	ERROR	MONITOR					
		A	B	C	D	E	F



POWER/MODE LED will turn on, and test run stops.

14-3. Error code

If an error occurs, the LED will light up to display the error location and the error code.

■ In the event of an error

The error LED blink quickly.

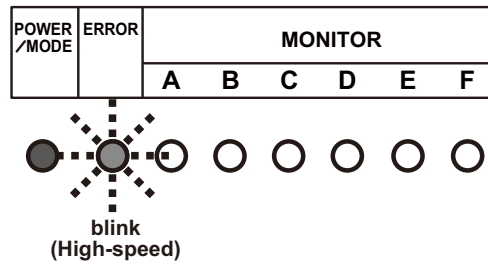

■ Error location display

LEDs A to F of MONITOR light up and display the error location. In the case of an overall error, LEDs A to F of MONITOR do not light up.

Example: Coil error in indoor unit B

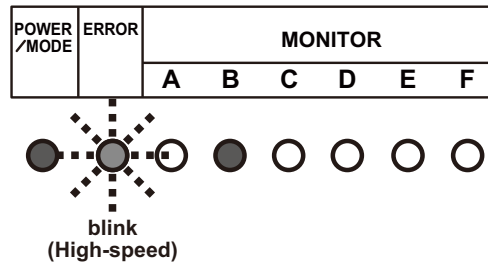

■ Error code display

While the error is occurring, briefly press SW1. The error code is displayed.

Example: Coil error (Error cord = 9A.1)

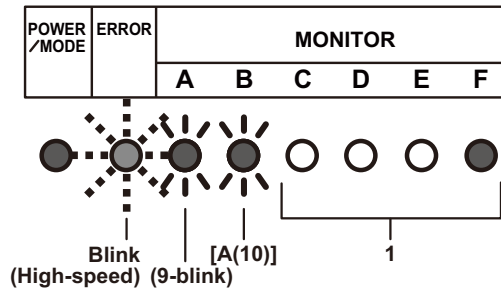

Display mode

LED on: ●

LED off: ○

Blink: 
(0.5s Light on / 0.5s Light off)

Number of blinking: ()

For MONITOR (A and B)

A: 10-Blink

C: 11-Blink

F: 12-Blink

J: 13-Blink

P: 14-Blink

U: 15-Blink

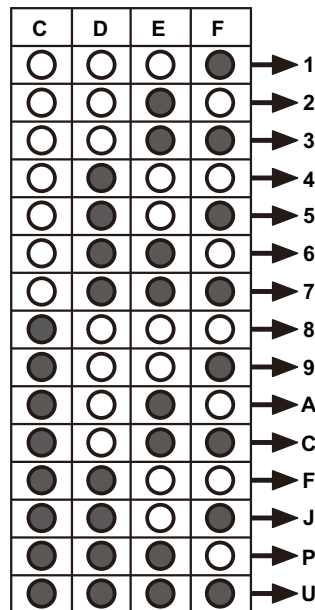

Error code	Error type
11.3	Serial communication error
11.4	Serial communication error during operation
16.5	Communication error between controller and outdoor unit
22.1	Indoor unit capacity error
5U.1	Indoor unit error
62.1	PCB model information error
62.3	EEPROM access error
62.8	EEPROM data corruption error
63.1	Inverter error
65.3	IPM error (Trip terminal L error)
71.1	Discharge temp. sensor error
72.1	Compressor temp. sensor error
73.2	Heat exchanger middle temp. sensor error
73.3	Heat exchanger liquid temp. sensor error
74.1	Outdoor temp. sensor error
75.1	Suction gas temp. sensor error
76.1	Valve sensor error
76.2	
77.1	Heat sink temp. sensor error
84.1	Current sensor 1 error (stoppage permanently)
86.1	Discharge pressure sensor error
94.1	Trip detection
95.1	Compressor motor control error (stoppage permanently)
97.3	Fan motor 1 error (Duty error)
98.3	Fan motor 2 error (Duty error)
99.1	4-way valve error
9A.1	Coil 1 (expansion valve 1) error
A1.1	Discharge temperature 1 error (stoppage permanently)
A3.1	Compressor 1 temperature error

14-4. Pump down

WARNING

During the pump down operation, make sure that compressor is off before you remove the refrigerant piping. Do not remove the connection pipe while the compressor is in operation with valve open. This may cause abnormal pressure in the refrigeration cycle that leads to breakage and even injury.

■ Pump down operation

When moving or discarding the air conditioner, in order to consider the environment and avoid the discharge of refrigerant to the atmosphere, pump down according to the following procedure.

1. Connect the pressure gauge to the charging port.
2. Change the DIP switch on the board (SET1-2) to On*1
*Be sure the power supply is disconnected on the breaker is turned off when changing the DIP switch.

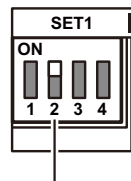

*1: DIP switch (SET1-2)

3. To start operation, press the [PUMP DOWN] switch*2 for 3 seconds or press after the power has been on for 3 min.

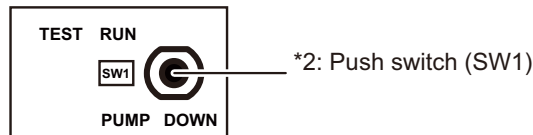

*2: Push switch (SW1)

During pump down, the LED (POWER/MODE) will flash 3 times consecutively.

POWER /MODE	ERROR	MONITOR					
		A	B	C	D	E	F



NOTE: If the [PUMP DOWN] switch is pressed during compressor operation, the compressor will stop, and the operation will start after about 3 min.

4. Close the liquid pipe valve.
5. When the value between 7.3 psi and 0 psi (0.05 Mpa to 0 Mpa) is shown, close the gas pipe valve.
6. Stop pump down by pressing the [PUMP DOWN] switch for 3 seconds.
The LED will light as follows.

POWER /MODE	ERROR	MONITOR					
		A	B	C	D	E	F



7. Disconnect the power supply or turn off the breaker.



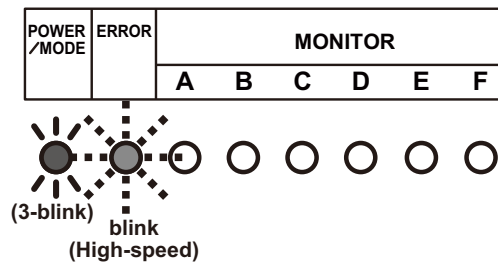

NOTE: If the pump down is not stopped by pressing the switch as in step 6, it will stop automatically after 15 minutes and the LED will light as follows. If the pump down is complete, disconnect the power supply or turn off the breaker. If not completed open the liquid pipe valve, and then start again from step 3.

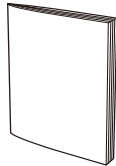
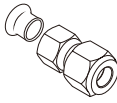

- In order to interrupt the pump down operation, press the [PUMP DOWN] switch again. The LED will return to the original display before starting pump down. (POWER/MODE LED: On)
- The pump down may stop before completion due to error. To complete the pump down, correct the error, open the liquid pipe valve and then start from step 1 again. Otherwise, the refrigerant can be recovered from the service port.

15. Accessories

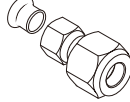
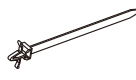
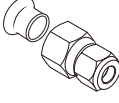
OUTDOOR UNIT
AOU36RLXFZH

Part name	Exterior	Q'ty	Part name	Exterior	Q'ty
Installation manual		1	Adapter K 1/2 in (12.70 mm) 3/8 in (9.52 mm)		1 set
Cable tie with clip (Large)		2	Adapter L 1/2 in (12.70 mm) 5/8 in (15.88 mm)		1 set
Cable tie with clip (Small)		2	Adapter H 3/8 in (9.52 mm) 1/2 in (12.70 mm)		1 set
Cable tie		1			

16. Optional parts

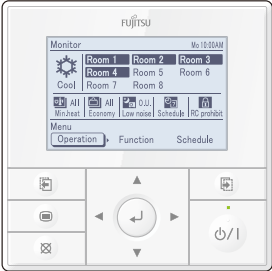
Exterior	Part name	Model name	Summary
 <p>The image shows a Fujitsu central remote controller. It features a large LCD screen at the top displaying a grid of room settings (Room 1 through Room 8) and various control icons. Below the screen is a navigation pad with four directional arrows and a central button, along with other function buttons like power and menu.</p>	<p>Central remote controller</p>	<p>UTY-DMMUM</p>	<p>Set temperatures on timers to best meet individuals' needs. Includes a large backlit LCD and 4-way navigation pad. Remote controller cable: 22AWG (0.33 mm²)</p> <p>NOTE: The remote controller cable supplied with this controller is for indoor use. If you require cables for outdoor use, purchase locally. Material is not specified. However, it should be selected considering the installing environment (temperature, humidity), and regional regulations (RoHS Directive, etc.).</p>

17. Installation precautions

17-1. Outdoor unit installation precautions

NOTE: The information listed below are general precautions. Some models also include items that do not apply.

■ Place where use prohibited use

- Places where there is a danger of combustible gas leakage.
- Places where sulfur gas, chlorine gas, acid, alkali, or other matter which effects equipment is generated.
- Places not affected by heat radiation from other heat sources.
- Places where the air is not stagnant.
- Places where machinery which generates high frequencies is used.
- Ocean beaches and other areas where there is a lot of salt.
- Inside of vehicles, ships, and other conveyances.
- Places where voltage fluctuations are product.

■ Points to remember when installing

- The product shall be installed at a place which can withstand the weight and vibration of the outdoor unit.
- To allow maintenance after refrigerant piping, drain piping, and electric wiring connection and installation, provide an installation service space.
*Installation service space is shown in “[Installation space](#)” on page 176.
- Be careful when installing the set at the following places.

Condition	Contents	Countermeasures (Reference)
When installed near adjacent houses.	Perform installation work so that operating sound does not disturb the neighbors.	1. Install a soundproof barrier. 2. Change the installation site.
When there is the possibility of strong wind.	<ul style="list-style-type: none">• If the outdoor unit is exposed to strong wind, capacity may drop, frost may form during heating, and operation may be stopped by high pressure rise. In addition, when a very strong wind blows, the fan may be damaged.• When a very strong wind blows, there is the possibility of the outdoor unit being toppled over if held only by foundation bolts.	1. Install the outdoor unit with keeping a sufficient distance between the outlet side of the unit and a facing wall or fence. 2. Make the outlet direction and wind direction perpendicular. 3. Fasten the outdoor unit using toppling prevention hardware (purchased locally).
When snow accumulates.	If the outdoor unit is covered by accumulated snow, it may not be able to operate.	1. Make the foundation as high as possible. 2. Perform snow prevention work.
When installing the inverter type.	It may generate noise in TV sets, stereos and PCs.	The inverter type should be installed at a sufficient distance from these equipments.