

# DISCAL® air separator



## 551 series



01060/18 NA  
Replaces 01060/16 NA



### Product range

551 series	DISCAL air separator for horizontal pipes, in brass compact with drain.....connections ¾" integral sweat; ¾" NPT female
551 series	DISCAL air separator for horizontal pipes, in brass with drain .....connections ¾", 1", 1¼", 1½" and 2" NPT female 1", 1¼", 1½" and 2" integral sweat 1", 1¼", 1½" and 2" integral press
551 series	DISCAL air separator for horizontal pipes, in steel with flanged connections and drain..... connections 2" to 6" ANSI
551 series	DISCAL air separator for horizontal pipes, in steel with threaded connections and drain .....connections 2" and 2½" integral NPT male
NA551 series	DISCAL air separator for horizontal pipes, in steel with flanged connections with drain, ASME and CRN .... connections 2" to 12" ANSI
5517 series	DISCAL air separator for horizontal or vertical pipes with rotating collar, in brass with drain..... connections ¾" and 1" sweat union, press union and NPT male union

### Technical specifications

#### Brass air separator

<b>Materials</b>	- body:	brass
	- internal element (compact & rotating collar versions):	304 stainless steel
	- internal element:	glass reinforced nylon PA66GF30
	- air vent float:	PP
	- seal:	peroxide-cured EPDM
	- air vent float linkages:	stainless steel
	- air vent float guide pin:	stainless steel

#### Performance

Suitable fluids:	water, glycol solution
Max. percentage of glycol:	50%
Max. working pressure:	150 psi (10 bar)
Temperature range:	32–250°F (0–120°C)
Air separation efficiency:	100% removal to micro-bubble level

#### Connections

- main:	
compact series:	¾" integral sweat; ¾" NPT female
horizontal:	¾", 1", 1¼", 1½" and 2" NPT female 1", 1¼", 1½" and 2" integral sweat 1", 1¼", 1½" and 2" integral press
rotating collar version, 5517 series:	¾" and 1" sweat, press and NPT male union
- lay length (press connections):	see page 2
- drain:	½" NPT female 5517 series: ½" straight female

### Function

The DISCAL® air separator is used to continuously remove the air contained in hydronic circuits of heating and cooling systems. The air discharge capacity is very high. They automatically remove all the air present in the system down to micro-bubble level with low head loss due to the special internal shape of the separator body. Flow direction of the DISCAL air separator is bidirectional; flow in either direction is permitted.

The circulation of fully de-aerated water enables the equipment to operate under optimum conditions, free from noise, corrosion, localized or mechanical damage. Micro-bubbles, fusing with each other, increase in volume (get larger) until they become large enough to rise to the top where they are automatically released.

#### Steel air separator

<b>Materials</b>	- body:	epoxy resin coated steel
	- internal element:	304 stainless steel
	- air vent float:	PP
	- seal:	peroxide-cured EPDM
	- air vent float linkages:	stainless steel
	- air vent float guide pin:	stainless steel
	- side drain shut-off valve:	brass

#### Performance

Suitable fluids:	water, glycol solution
Max. percentage of glycol:	50%
Max. working pressure:	sizes 2 - 6 inch: 150 psi (10 bar) sizes 8 - 12 inch: 200 psi (14 bar)
Temperature range (vessel):	32–270°F (0–132°C)
Air separation efficiency:	100% removal to microbubble level

#### Connections

- flanged:	2"–12" ANSI B16.5 150 CLASS RF
- drain pipe:	sizes 2 - 6 inch: 1" NPT male sizes 8 - 12 inch: 2" NPT male
- side drain shut-off valve:	¾" GHT
- thermo well tap (8 - 12" only):	
- inlet/outlet flanges:	½" NPT female

#### Agency Approval

NA551 series is designed and built in accordance with Section VIII, Division 1 of the ASME Boiler and Pressure Vessel Code and tagged and registered with the National Board of Boiler and Pressure Vessel Inspectors, stamped for 150 psi (10 bar) working pressure for 2 - 6 inch, 200 psi (14 bar) for 8 - 12 inch, with ASME U stamp and CRN registered (CRN pending for 12 inch, consult Caleffi).

## Dimensions

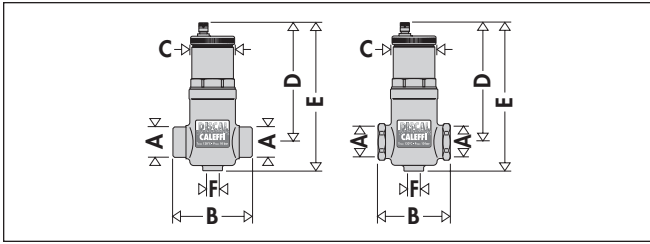

Code	A	B	C	D	E	F	Wt (lb)
551003A*	3/4" NPT	3/16"	2 3/16"	5 3/8"	6 7/8"	1/2"	2.0
551022A*	3/4" SWT	3/16"	2 3/16"	5 3/8"	6 7/8"	1/2"	2.0

\*Add suffix C to sweat and NPT code number when ordering the brass DISCAL to ship with expansion tank service check valve, code 561402A.

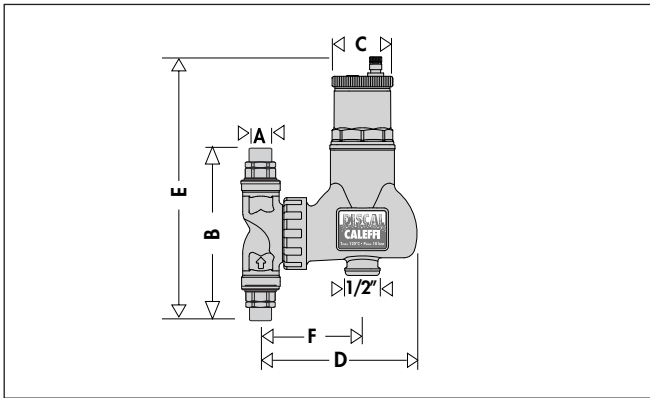

Code	A	B	C	D	E	F	Wt (lb)
551705A	3/4" NPT	5 1/8"	2 3/16"	5 3/8"	9 1/4"	3 1/2"	4.9
551765A	3/4" press	6 5/8"	2 3/16"	5 3/8"	9 3/4"	3 1/2"	4.9
551795A	3/4" SWT	6"	2 3/16"	5 3/8"	9 3/16"	3 1/2"	4.9
551706A	1" NPT	6 3/4"	2 3/16"	5 3/8"	9 3/4"	3 1/2"	4.9
551766A	1" press	6 3/4"	2 3/16"	5 3/8"	9 3/4"	3 1/2"	4.9
551796A	1" SWT	7"	2 3/16"	5 3/8"	9 3/4"	3 1/2"	4.9
551716*	--	3 3/4"	2 3/16"	5 3/8"	9 1/4"	3 1/2"	4.4

\*Body only, no end connection fittings. Source separately, see Caleffi catalog for end connection code numbers.

Code	A	Lay length
551765A	3/4" press	4 5/8"
551766A	1" press	4 3/4"

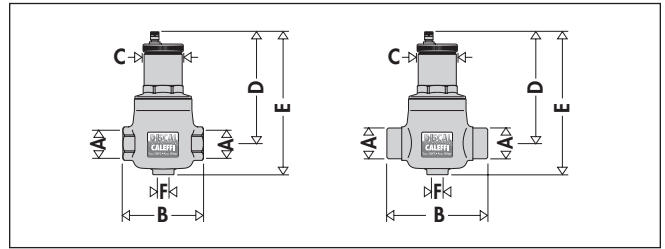

Code	A	B	C	D	E	F	Wt (lb)
551005A*	3/4" NPT	4 5/16"	2 3/16"	5 3/4"	7 1/2"	1/2"	3.7
551006A*	1" NPT	4 5/16"	2 3/16"	5 3/4"	7 1/2"	1/2"	3.7
551007A*	1 1/4" NPT	4 7/8"	2 3/16"	6 9/16"	8 1/4"	1/2"	4.9
551008A*	1 1/2" NPT	4 7/8"	2 3/16"	6 9/16"	8 1/4"	1/2"	4.9
551009A*	2" NPT	5 1/8"	2 3/16"	6 9/16"	8 1/4"	1/2"	5.5
551028A*	1" SWT	5 1/16"	2 3/16"	5 3/4"	7 1/2"	1/2"	3.7
551035A*	1 1/4" SWT	5 3/16"	2 3/16"	6 9/16"	8 1/4"	1/2"	3.7
551041A*	1 1/2" SWT	5 3/4"	2 3/16"	6 9/16"	8 1/4"	1/2"	4.9
551054A*	2" SWT	6 1/8"	2 3/16"	6 9/16"	8 1/4"	1/2"	5.5

\*Add suffix C to sweat, NPT and press (below) code numbers when ordering the brass DISCAL to ship with expansion tank service check valve, code 561402A.

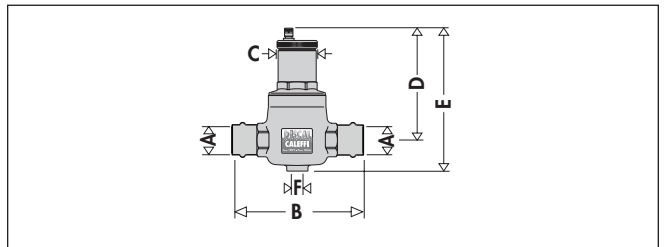

Code	A	B	C	D	E	F	Wt (lb)
551066A*	1" press	6 3/16"	2 3/16"	5 3/4"	7 1/2"	1/2"	3.8
551067A*	1 1/4" press	7 7/16"	2 3/16"	5 3/4"	7 1/2"	1/2"	5.0
551068A*	1 1/2" press	8"	2 3/16"	6 9/16"	8 1/4"	1/2"	5.1
551069A*	2" press	8 1/2"	2 3/16"	6 9/16"	8 1/4"	1/2"	5.5

Code	A	Lay length
551066A*	1" press	4 1/2"
551067A*	1 1/4" press	5 1/8"
551068A*	1 1/2" press	5 1/4"
551069A*	2" press	5 1/2"

## Dimensions

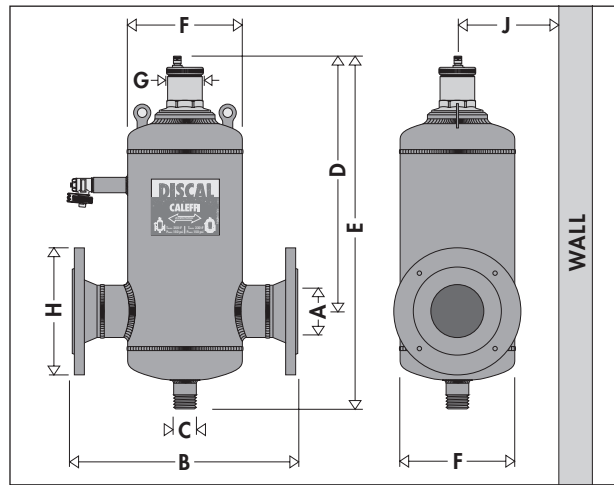

Code	A	B	C	D	E	F	G	H	J†	Wt (lb)
**551050A	2"	13¾"	1"	14¾"	19 <sup>15</sup> / <sub>16</sub> "	6 <sup>5</sup> / <sub>8</sub> "	2 <sup>13</sup> / <sub>16</sub> "	6"	6 <sup>5</sup> / <sub>16</sub> "	34
**551060A	2½"	13¾"	1"	14¾"	19 <sup>15</sup> / <sub>16</sub> "	6 <sup>5</sup> / <sub>8</sub> "	2 <sup>13</sup> / <sub>16</sub> "	7"	6 <sup>5</sup> / <sub>16</sub> "	35
**551080A	3"	18 <sup>3</sup> / <sub>8</sub> "	1"	17 <sup>1</sup> / <sub>8</sub> "	23 <sup>7</sup> / <sub>16</sub> "	8 <sup>5</sup> / <sub>8</sub> "	2 <sup>13</sup> / <sub>16</sub> "	7½"	7 <sup>5</sup> / <sub>16</sub> "	62
**551100A	4"	18½"	1"	17 <sup>1</sup> / <sub>8</sub> "	23 <sup>7</sup> / <sub>16</sub> "	8 <sup>5</sup> / <sub>8</sub> "	2 <sup>13</sup> / <sub>16</sub> "	9"	7 <sup>5</sup> / <sub>16</sub> "	67
NA551120A	5"	25"	1"	21 <sup>1</sup> / <sub>8</sub> "	30½"	12¾"	2 <sup>13</sup> / <sub>16</sub> "	10"	9 <sup>3</sup> / <sub>8</sub> "	106
NA551150A	6"	25"	1"	21 <sup>1</sup> / <sub>8</sub> "	30½"	12¾"	2 <sup>13</sup> / <sub>16</sub> "	10"	9 <sup>3</sup> / <sub>8</sub> "	117

Size	2"	2 ½"	3"	4"	5"	6"
Cap. (gal)	1.8	1.8	4.8	4.8	13.7	13.7

\*\*Add prefix NA to flanged code number when ordering ASME tagged and registered with the National Board of boiler and Pressure Vessel Inspector and CRN registered.

†This dimension allows for a minimum of 3" wall clearance to accommodate insulation if used.

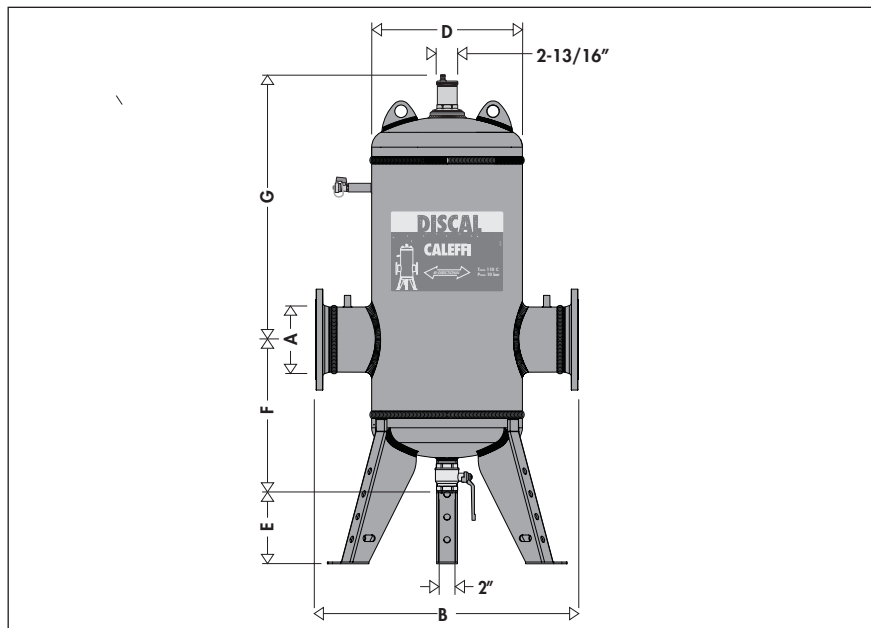

Code	A	B	D	E	F	G	Cap. (gal)	Wt (lb)
NA551200A	8"	35 7/16"	20"	8 1/2"	20"	32 1/2"	56	335
NA551250A	10"	41 3/4"	26"	8 1/2"	22 5/8"	38 1/4"	110	617
NA551300A	12"	46 1/2"	30"	8 1/2"	25 3/8"	43 3/8"	169	871

These models are ASME tagged and registered with the National Board of Boiler and Pressure Vessel Inspector and CRN registered (12" pending, consult Caleffi).

**NOTE:** Drawings may not reflect the actual size of the separators.

## The process of air formation

The amount of air which can remain dissolved in a water solution is a function of pressure and temperature. This relationship is governed by Henry's Law and the graph below demonstrates the physical phenomenon of the air release from water. As an example, at a constant absolute pressure of 30 psi (2 bar), if the water is heated from 65°F (18°C) to 170°F (75°C), the amount of air released by the solution is equal to 1.8 gallons of air per 100 gallons of water. According to this law it can be seen that the amount of air released increases with temperature rise and pressure reduction. The air comes in the form of micro-bubbles of diameters in the order of tenths of a millimeter.

In heating and cooling systems there are specific points where this process of formation of micro-bubbles takes place continuously: in the boiler and in any device which operates under conditions of cavitation.

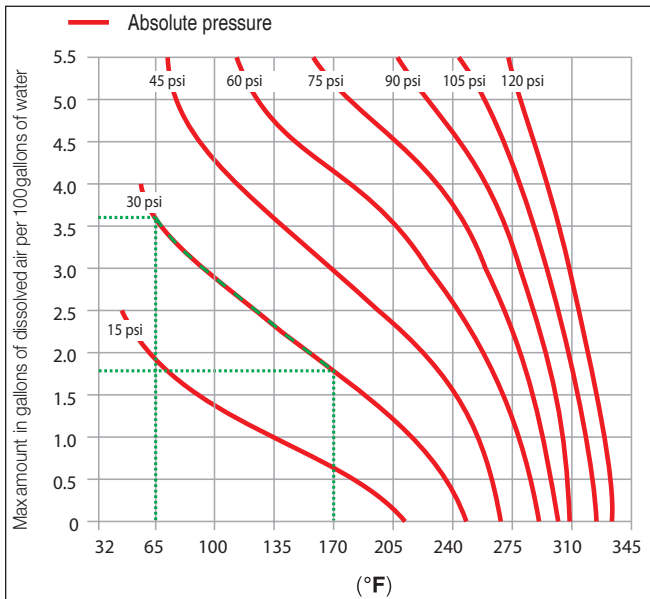

## Boiler micro-bubbles

Micro-bubbles are formed continuously on the surface separating the water from the combustion chamber due to the fluid temperature. This air, carried by the water, collects in the critical points of the circuit from where it must be removed.

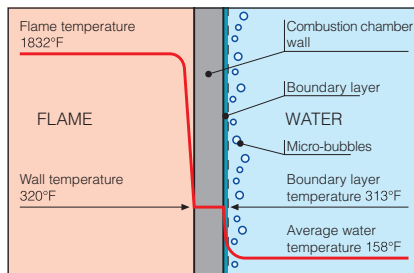

Some of this air is reabsorbed in the presence of colder surfaces.

## Cavitation and micro-bubbles

Micro-bubbles develop where the fluid velocity is very high with the corresponding reduction in pressure. These points are typically the pump impeller and the valve port.

These air and vapor micro-bubbles, the formation of which is enhanced in the case of non de-aerated water, may subsequently implode due to the cavitation phenomenon.

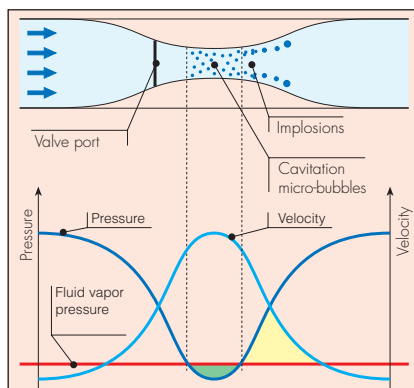

## Operating principles

The DISCAL air separator is used to continuously remove the air contained in hydronic circuits of heating and cooling systems. The air discharge capacity is very high. They are capable of removing automatically all the air present in the system down to micro-bubble level with low head loss due the special internal shape of the separator body. Flow direction of the DISCAL air separator is bidirectional; flow in either direction is permitted.

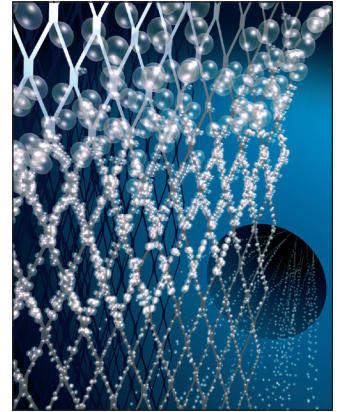

The air separator uses the combined action of several physical principles. The active part consists of an assembly of concentric mesh surfaces (1). These elements create the whirling movement required to facilitate the release of micro-bubbles and their adhesion to these surfaces.

The bubbles, fusing with each other, increase in size until the hydrostatic thrust overcomes the adhesion force to the mesh. They rise towards the top of the unit from which they are released through a float-operated (2) automatic air vent, with stainless steel float guide pin (3) and stainless steel float linkages (4).

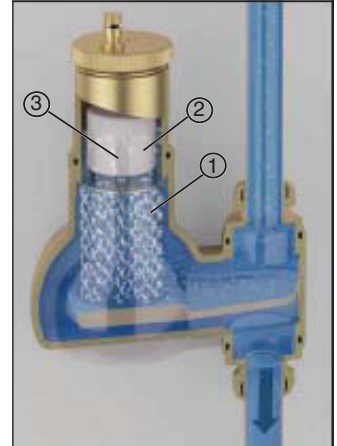

### 551 compact series

### 551 brass series

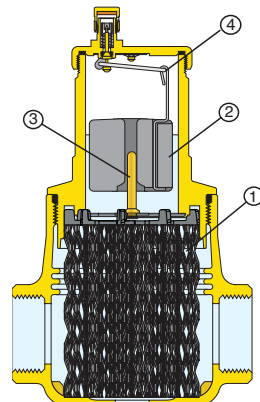
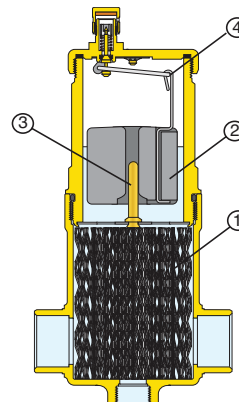

### 5517 rotating collar series

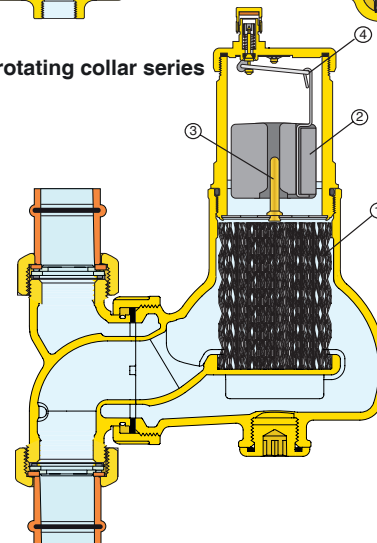

**551 and NA551 steel series**

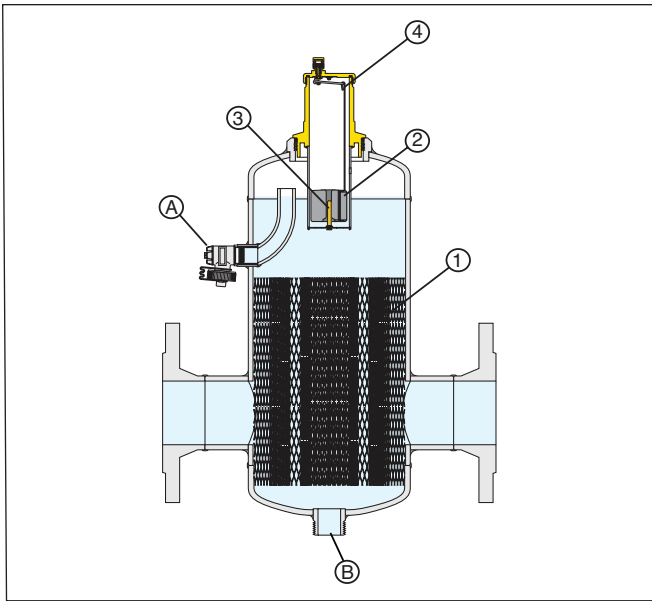

**Steel models**

Steel flanged models come standard with a side drain valve (A) to drain large amounts of air when filling the circuit and to remove any debris present above the water level.

A 1" drain valve (code NA39753) can be connected (B) at the bottom of the 2" - 6" steel flanged DISCAL to drain collected dirt particles.

**Construction details**

DISCAL air separators are designed to allow maintenance and cleaning without having to remove the valve body from the pipework. All DISCAL air separators come standard with a bottom connection for installing a drain valve. All internal air release control components are fully accessible in all the models.

The automatic air vent, located at the top of the units, has a long chamber for the movement of the float. This feature prevents any debris present in the water from reaching the sealing seat. A stainless steel float guide pin (3), along with a stainless steel float linkage (4) prevents the float from sticking due to accumulating residue in the flowing fluids, even when the DISCAL air separator is not installed perfectly vertical.

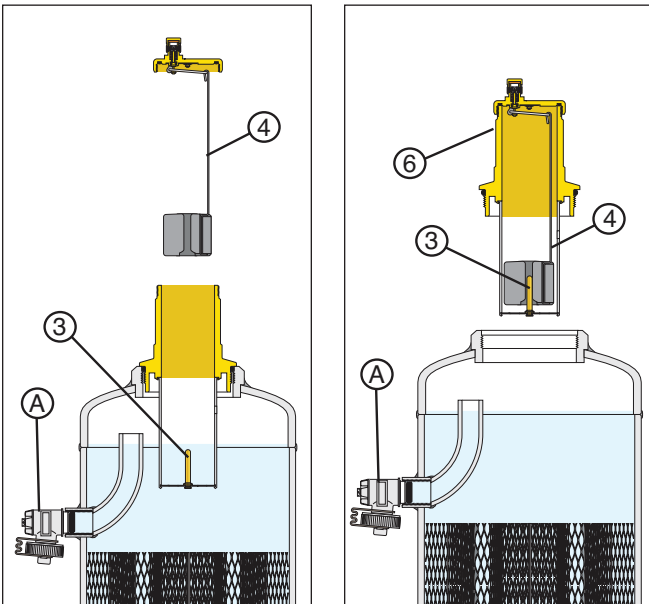

A replacement air vent assembly for the DISCAL brass 551 series (except rotating collar and compact versions) is code 59829; for the DISCAL steel 551 and NA551 series is code 59756.



F39807

The moving parts that control air venting are accessed simply by removing the upper cover (5). Replacement cap and float assembly for all versions of the brass DISCAL551 and 5517 series is code F39807.

When cleaning, simply unscrew the portion of the body containing the automatic air vent (6). For rotating collar and compact models the air vent body is not removable so the internal mesh element can be pulled out by removing the upper cover (5).

DISCAL air separators with flanged end connections have an integral side drain port with brass shutoff drain valve, code 538402 FD (A), which has two functions:

1. Air removal while filling the system during system commissioning.
2. Debris removal that float within the air separator.

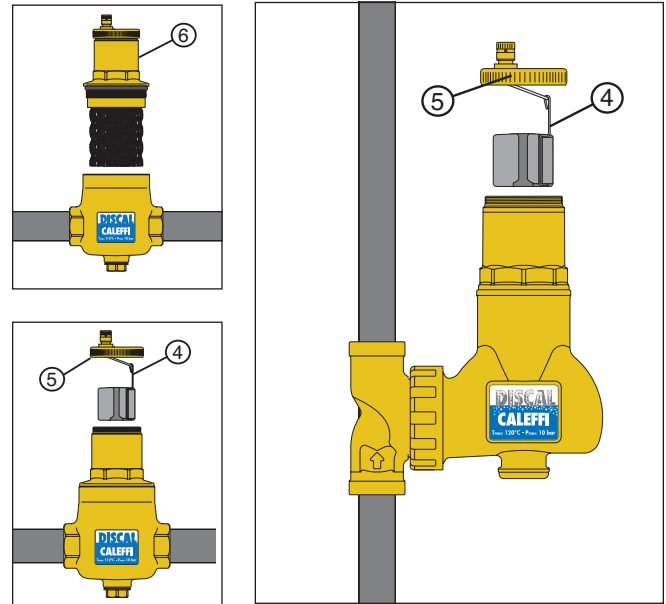

## Air separation efficiency

DISCAL air separators continuously remove entrained air in hydronic systems with very high separation efficiency. The amount of air removed from a system varies depending on fluid velocity and temperature. As illustrated on the graph, at the 4.0 feet per second fluid velocity, all the air artificially introduced into the system is gradually eliminated during normal system operation by the DISCAL air separator. In conditions where the fluid velocity is slower or the temperature of the fluid is higher, the amount of air separated is even faster.

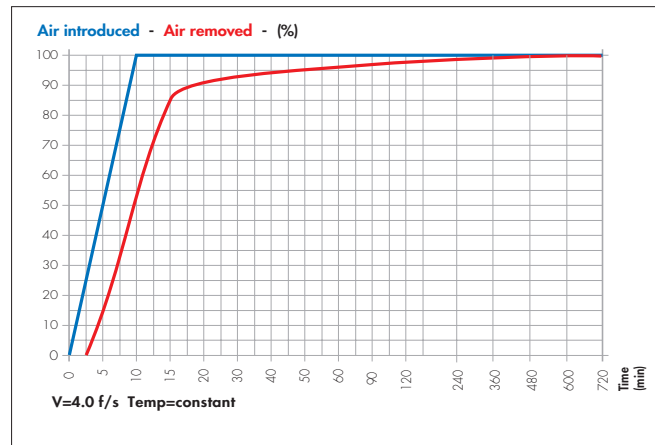

## Hydraulic characteristics

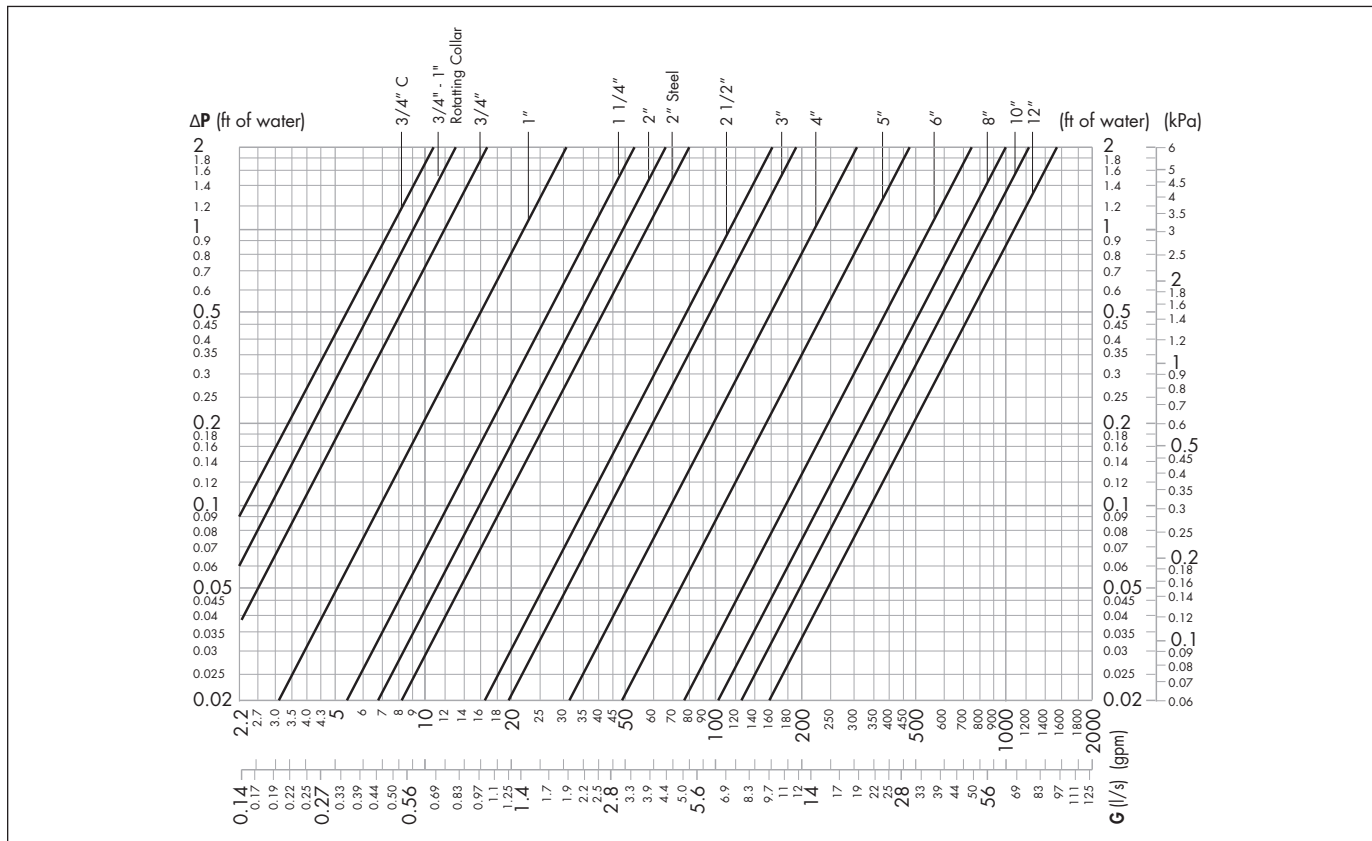

ft of water x .433 = psi

		Flow capacity – brass						
		3/4" C/R	3/4"	1"R	1"	1 1/4"	1 1/2"	2"
4.0 f/s	GPM	6	6	10	10	15	22	39
	l/s	0.4	0.4	0.6	0.6	1.0	1.4	2.5
	Cv	12/14	19	14	32	56	73	81

**R:** 5517 series rotating collar version.

**C:** Compact version.

		Flow capacity – steel								
		2"	2 1/2"	3"	4"	5"	6"	8"	10"	12"
4.0 f/s	GPM	39	60	90	160	245	355	625	980	1,410
	l/s	2.5	3.8	5.7	10	15.5	22.4	40.0	62.0	89.0
10.0 f/s	GPM	100	155	220	400	615	880	1,570	2,450	3,530
	l/s	6.3	9.8	14	25.2	38.8	55.5	99.0	154.5	222.7
	Cv	87	174	208	324	520	832	1,109	1,387	1,664

## Insulation shells

Insulation shells for brass DISCAL series for horizontal pipes. These are not designed for the compact or 517 series rotating collar DISCAL.

Code	Size
CBN551005	For ¾" and 1"
CBN551007	For 1¼" and 1½"
CBN551009	For 2"



## Insulation

Material: closed cell expanded PE-X  
 Thickness: 25/64" (10 mm)  
 Density - inner part: 1.9 lb/ft<sup>3</sup> (30 kg/m<sup>3</sup>)  
 - outer part: 3.1 lb/ft<sup>3</sup> (50 kg/m<sup>3</sup>)  
 Thermal conductivity (DIN 52612)  
 - at 32°F (0°C): 0.263 BTU-in/hr-ft<sup>2</sup>·°F (0.038 W/(m·K))  
 - at 104°F (40°C): 0.312 BTU-in/hr-ft<sup>2</sup>·°F (0.045 W/(m·K))  
 Coefficient of resistance to water vapor (DIN 52615): >1,300  
 Working temperature range: 32–212°F (0–100°C)

## Accessories

Item	Code	Description
	561402A	Check valve for expansion tanks. 1/2" NPT connections.
	R59681	Hydroscopic safety vent cap.
	562100	Small anti-vacuum vent cap.
	59119	Replacement DISCAL air vent cap.

Optional drain valves, separator sizes 2" - 6", code NA39753 (1" NPT female with T handle); separator sizes 8" - 12", code NA59600 (2" NPT female with lever).

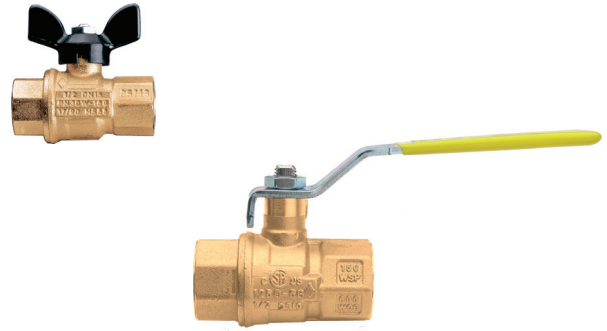

## Installation

DISCAL units may be used in heating or cooling systems to ensure the progressive removal of air which is continuously formed. The units should preferably be installed after the boiler and on the pump suction side, as these are the points where the formation of micro-bubbles is greatest. DISCAL air separators for horizontal pipes must be installed vertically. Flow direction of the DISCAL air separator is bidirectional (flow in either direction is permitted), except for the 5517 series rotating collar version. For the 5517 series, the correct flow direction is shown by an arrow on the T-fitting. Turn the T-fitting by hand to correctly orient it to install in either horizontal or vertical piping. In installation conditions where inspection is not possible, it is recommended that the venting valve cap is replaced by a Caleffi Code R59681 hydroscopic safety vent.

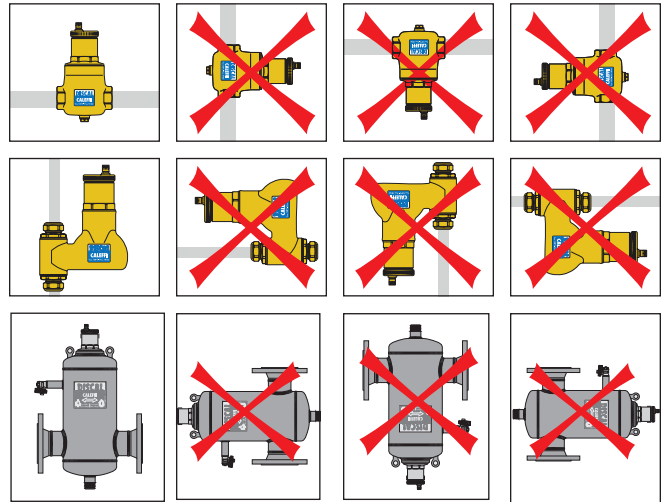
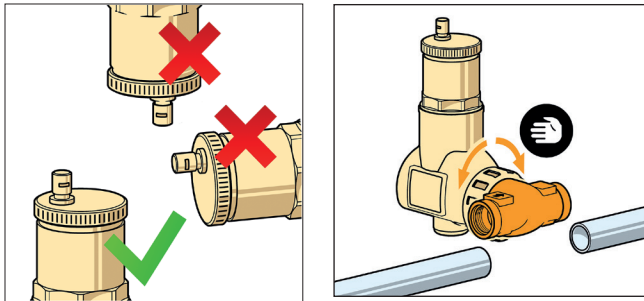

## Application diagram

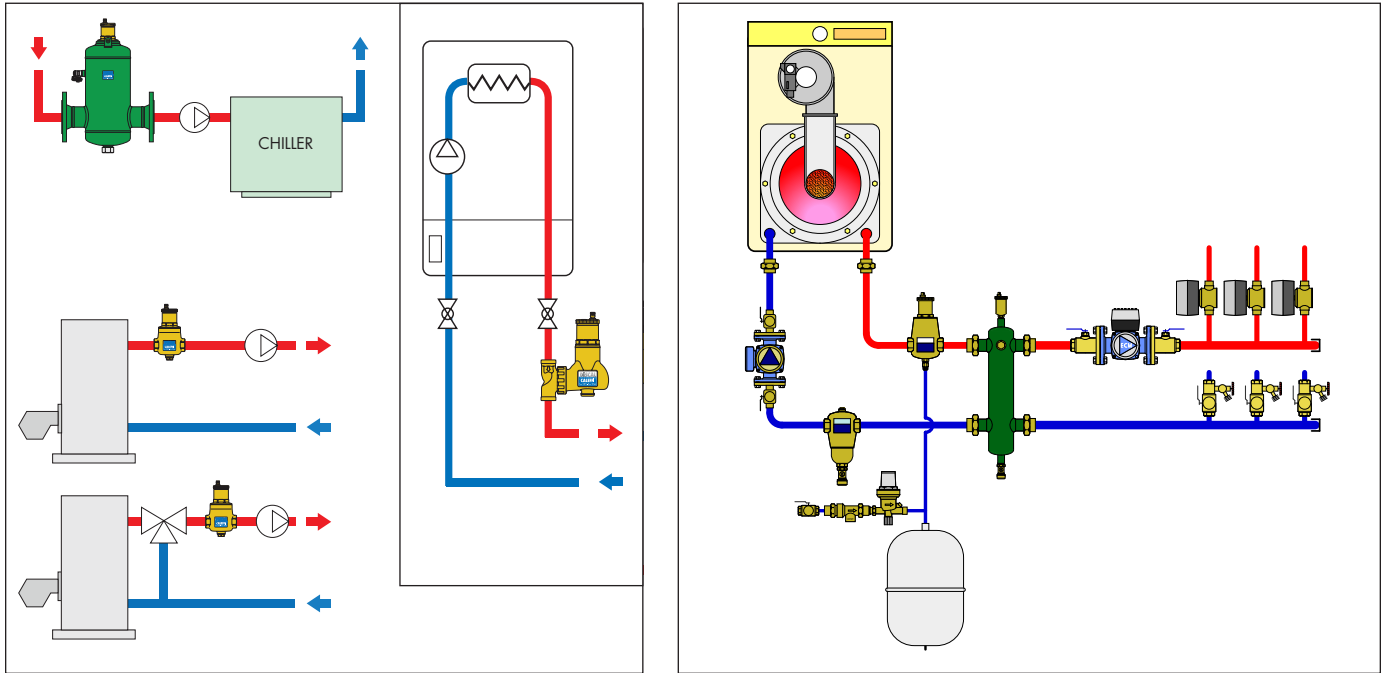

## SPECIFICATION SUMMARIES

### DISCAL® 551 series – Compact

Air separator in brass complete with brass automatic air vent containing pinned float. Connections for horizontal pipes, 3/4" NPT female threads or 3/4" sweat. Brass body. Peroxide-cured EPDM seals. 304 stainless steel internal mesh element. PP float. Stainless steel float linkages. Stainless steel float guide pin. Bottom 1/2" NPT female thread for drain. Models available with pre-installed service check valve. Maximum working pressure 150 psi (10 bar), Temperature range 32 to 250°F (0 to 120°C). Glycol maximum 50%. Air separation efficiency: 100% removal to micro-bubble level.

### DISCAL® 551 series

Air separator in brass complete with brass automatic air vent containing pinned float. Connections for horizontal pipes, 3/4" to 2" NPT female threads, 1" to 2" sweat and 1", 1-1/4" integral press. Brass body. Peroxide-cured EPDM seals. Glass reinforced nylon PA66G30 internal mesh element. PP float. Stainless steel float linkages. Stainless steel float guide pin. Bottom 1/2" NPT female thread for drain. Models available with pre-installed service check valve. Maximum working pressure 150 psi (10 bar), Temperature range 32 to 250°F (0 to 120°C). Glycol maximum 50%. Air separation efficiency: 100% removal to micro-bubble level. Provide with insulation shell, code CBN551 series.

### DISCAL® 5517 series - Rotating collar

Air separator in brass complete with brass automatic air vent containing pinned float. Connections for horizontal and vertical pipes, 3/4" to 1" sweat, press and NPT male thread with union nuts. Brass body. Peroxide-cured EPDM seals. 304 stainless steel internal mesh element. PP float. Stainless steel float linkages. Stainless steel float guide pin. Bottom 1/2" straight female thread for drain. Maximum working pressure 150 psi (10 bar). Temperature range 32 to 250°F (0 to 120°C). Glycol maximum 50%. Air separation efficiency: 100% removal to micro-bubble level.

### DISCAL® 551 series - Flanged

Air separator in steel with brass side drain valve and automatic air vent with pinned float. Flanged ANSI B16.5 CLASS 150 RF connections from 2" to 6" for horizontal pipes. Epoxy resin coated steel body. Peroxide-cured EPDM seal. 304 Stainless steel internal mesh element. PP float. Stainless steel float linkages. Stainless steel float guide pin. Bottom 1" NPT male thread for drain and side drain port supplied with integral brass shutoff valve, code 538402 FD, and 3/4" garden hose connection. Provide with separately purchased brass drain ball valve, 1" NPT female with T handle, code NA39753. Maximum working pressure 150 psi (10 bar). Vessel working temperature range 32 to 270°F (0 to 132°C). Glycol maximum 50%. Air separation efficiency: 100% removal to micro-bubble level.

### DISCAL® 551 series - Flanged, ASME & CRN

Air separator in steel with brass side drain valve and automatic air vent with pinned float. Flanged ANSI B16.5 CLASS 150 RF connections from 2" to 12" for horizontal pipes. Epoxy resin coated steel body. Peroxide-cured EPDM seal. 304 Stainless steel internal mesh element. PP float. Stainless steel float linkages. Stainless steel float guide pin. Bottom 1" NPT male thread for drain, 2" to 6" separators, 2" NPT male thread for drain, 8" to 12" separators, and side drain port supplied with integral brass shutoff valve, code 538402 FD, and 3/4" garden hose connection. For separator size 8" to 12" only thermometer pocket well on inlet/outlet flanges 1/2" NPT female. Provide with separately purchased brass drain ball valve, for 2" to 6" size separators 1" NPT female with T handle, code NA39753. For 8" to 12" size separators 2" NPT female with lever handle, code NA59600, is supplied but not attached. Maximum working pressure for 2" to 6" separators 150 psi (10 bar), for 8" to 12" separators 200 psi (14 bar). Vessel working temperature range 32 to 270°F (0 to 132°C). Glycol maximum 50%. Air separation efficiency: 100% removal to micro-bubble level. Designed and built in accordance with Section VIII, Division 1 of the ASME Boiler and Pressure Vessel Code and tagged and registered with the National Board of Boiler and Pressure Vessel Inspector, and CRN registered (pending for 12"), and stamped for 150 psi (10 bar) working pressure, with ASME U stamp.

We reserve the right to change our products and their relevant technical data, contained in this publication, at any time and without prior notice.



Caleffi North America, Inc.  
3883 W. Milwaukee Road  
Milwaukee, WI 53208  
Tel: 414-238-2360 · Fax: 414-238-2366  
sales@caleffi.com · www.caleffi.com  
© Copyright 2018 Caleffi North America, Inc.