

# Media Specifications

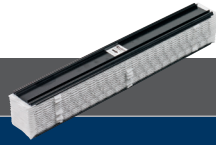

REPLACEMENT MEDIA				
Media No.	Used with Aprilaire Air Cleaner Models	Nominal Size (in inches)	Static Pressure Drop (in. w.c.) @ 1200 CFM	Maximum Airflow Capacity (in CFM)
<b>501</b>	5000	16" x 25"	0.14	2000
<b>113</b>	1110	16" x 20"	0.29	1200
<b>213</b>	1210, 1620, 2210, 3210, 4200*	20" x 25"	0.15	2000
<b>313</b>	1310, 2310, 3310, 4300*	20" x 20"	0.23	1200
<b>413</b>	1410, 1610, 2410, 3410, 4400*	16" x 25"	0.17	2000
<b>513</b>	1510	31" x 28"	0.07	3000
<b>110</b>	1110	16" x 20"	0.20	1200
<b>210</b>	1210, 1620, 2210, 3210, 4200*	20" x 25"	0.11	2000
<b>310</b>	1310, 2310, 3310, 4300*	20" x 20"	0.19	1200
<b>410</b>	1410, 1610, 2410, 3410, 4400*	16" x 25"	0.12	2000
<b>510</b>	1510	31" x 28"	0.05	3000
<b>201</b>	2200 Space-Gard, 2200 Aprilaire	20" x 25"	0.14	2000
<b>401</b>	2400 Space-Gard, 2400 Aprilaire	16" x 25"	0.14	2000

EAC

MERV 13

MERV 11

MERV 10

UPGRADE KITS					
Media No.	Used With Space-Gard & Aprilaire Air Cleaner Models	Nominal Size (in inches)	Included Media	Static Pressure Drop (in. w.c.) @ 1200 CFM	Maximum Airflow Capacity* (in CFM)
<b>1213</b>	2200*	20" x 25"	213	0.15	2000
<b>1413</b>	2400*	16" x 25"	413	0.17	2000

MERV 13

REMOVAL EFFICIENCY (Based on Particle Size)			
	0.3-1.0 Microns	1.0-3.0 Microns	3.0-10 Microns
<b>EAC</b>	89%	95%	98%
<b>MERV 13</b>	63%	88%	93%
<b>MERV 11</b>	37%	67%	92%
<b>MERV 10</b>	22%	56%	92%

\*Air cleaner models no longer available.

Test Method - EAC - AHRI 680-2009, MERV 10-13 - ASHRAE 52.2.2012

COMPATIBLE				
Upgrade Kit	Fits Air Cleaner Size	Filters	Fits Air Cleaner Models by:	Maximum Airflow Capacity (in CFM)
Model 4897	16" x 25"	610, 613	Carrier General Honeywell Lennox Trion Ultravation	2000
	20" x 25"	810, 813		2000
Model 4898	16" x 20"	110, 113		1200
	20" x 20"	310, 313		1200

PRESSURE DROP CHART															
Media No.	Static Pressures at Variable CFM (in. w.c.)														
	200	400	600	800	1000	1200	1400	1600	1800	2000	2200	2400	2600	2800	3000
501	0.02	0.04	0.05	0.08	0.10	0.14	0.17	0.21	0.25	0.29	-	-	-	-	-
113	0.03	0.07	0.11	0.16	0.22	0.29	-	-	-	-	-	-	-	-	-
213	0.02	0.04	0.06	0.09	0.12	0.15	0.19	0.23	0.27	0.31	-	-	-	-	-
313	0.03	0.05	0.09	0.13	0.17	0.23	-	-	-	-	-	-	-	-	-
413	0.02	0.05	0.07	0.10	0.14	0.17	0.22	0.26	0.31	0.37	-	-	-	-	-
513	0.01	0.02	0.04	0.05	0.05	0.07	0.08	0.10	0.11	0.13	0.15	0.17	0.18	0.20	0.23
613	0.02	0.05	0.07	0.10	0.14	0.17	0.22	0.26	0.31	0.37	-	-	-	-	-
813	0.02	0.04	0.06	0.09	0.12	0.15	0.19	0.23	0.27	0.31	-	-	-	-	-
110	0.02	0.05	0.06	0.10	0.14	0.20	-	-	-	-	-	-	-	-	-
210	0.02	0.03	0.04	0.06	0.08	0.11	0.13	0.16	0.19	0.22	-	-	-	-	-
310	0.02	0.04	0.06	0.10	0.14	0.19	-	-	-	-	-	-	-	-	-
410	0.02	0.03	0.05	0.07	0.09	0.12	0.15	0.19	0.22	0.27	-	-	-	-	-
510	0.02	0.02	0.03	0.04	0.04	0.05	0.06	0.07	0.09	0.10	0.12	0.14	0.15	0.17	0.19
610	0.02	0.03	0.05	0.07	0.09	0.12	0.15	0.19	0.22	0.27	-	-	-	-	-
810	0.02	0.03	0.04	0.06	0.08	0.11	0.13	0.16	0.19	0.22	-	-	-	-	-
201	0.02	0.04	0.05	0.08	0.10	0.14	0.17	0.21	0.25	0.29	-	-	-	-	-
401	0.02	0.04	0.05	0.08	0.10	0.14	0.17	0.21	0.25	0.29	-	-	-	-	-

EAC  
MERV 13  
MERV 11  
MERV 10

# 1000 Series WHOLE-HOME AIR CLEANER

## 1000 SERIES SPECIFICATIONS AND SIZING SUMMARY

Model	Nominal Size	Shipping Weight	Replacement Media	
			Ships With	Upgrade To
1110	16" x 20"	13 lbs.	Model 110	Model 113
1210	20" x 25"	18 lbs.	Model 210	Model 213
1310	20" x 20"	15 lbs.	Model 310	Model 313
1410	16" x 25"	17 lbs.	Model 410	Model 413

### Inlet Side Return Duct Connection

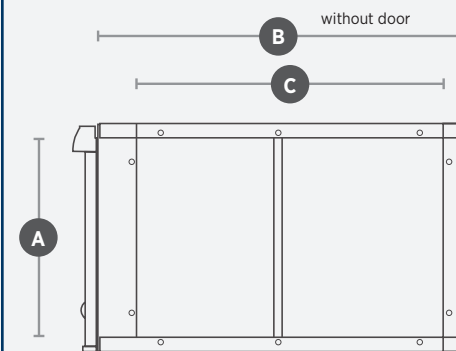

### Front



### Outlet Side Furnace Connection

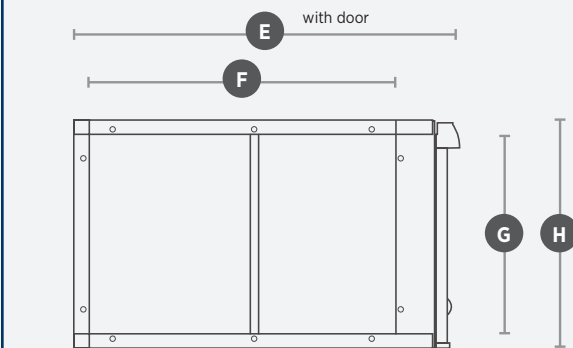

Dim.	Description	Model			
		1110	1210	1310	1410
A	Inlet Opening Height	15 1/8" (392mm)	19 3/4" (502mm)	18 1/8" (459mm)	15 1/8" (392mm)
B	Outer Housing Depth without Door	20 1/8" (509.5mm)	25 3/8" (645mm)	20 1/8" (509.5mm)	28 1/8" (713mm)
C	Inlet Opening Width	17 3/8" (441mm)	21 3/8" (538mm)	15 7/8" (403mm)	23 3/8" (606mm)
D	Unit Width	6 3/4" (171mm)	6 3/4" (171mm)	6 3/4" (171mm)	6 3/4" (171mm)
E	Outer Housing Depth with Door	22 1/8" (560mm)	27 3/8" (695mm)	22 1/8" (560mm)	30 1/8" (763mm)
F	Outlet Opening Width	17 3/8" (441mm)	21 3/8" (538mm)	15 7/8" (403mm)	23 3/8" (606mm)
G	Outlet Opening Height	15 1/8" (392mm)	19 3/4" (502mm)	18 1/8" (459mm)	15 1/8" (392mm)
H	Unit Height	17 3/4" (451mm)	22 3/8" (560mm)	20 3/8" (518mm)	17 3/4" (451mm)



With multiple sizes and narrow profile, Aprilaire has the right solution for any application, including new installs, system replacements or add-ons.

Protect equipment, reduce callbacks and grow revenue with our patented media.

## ► FEATURES

- + Ships with MERV 11 filter
- + Can be upgraded to MERV 13 filter with simple media change
- + Minimal maintenance required — simply replace media annually
- + Made of corrosion-resistant heavy gauge galvanized steel
- + Proprietary door design and Self-Seal™ media virtually eliminates air bypass, delivering MERV performance as rated
- + UL classified cabinet and media
- + Load rated up to 400 lbs.
- + 5-year warranty on cabinet from date of installation

## ► BENEFITS

- + Offers equipment protection from dust buildup
- + Assured equipment performance
- + Media revenue — HVAC channel only
- + Superior performance over one inch panel filters and four inch cartridge filters