



▶ FEATURES

- + Ships with MERV 11 filter
- + Can be upgraded to MERV 13 filter with simple media change
- + Minimal maintenance required — simply replace media annually
- + Made of corrosion-resistant heavy gauge galvanized steel
- + Proprietary door design and Self-Seal™ media virtually eliminates air bypass, delivering MERV performance as rated
- + UL classified cabinet and media
- + Load rated up to 400 lbs.
- + 5-year warranty on cabinet from date of installation

▶ BENEFITS

- + Offers equipment protection from dust buildup
- + Assured equipment performance
- + Superior performance over one inch panel filters and four inch cartridge filters

PRODUCT SPECIFICATIONS

	Nominal Size (In Inches)	Shipping Weight	MERV 11				MERV 13							
			Replacement Media	Resistance @ Airflow Volume (Inches w.c. @CFM)		Shipping Weight (full carton)	Filtering Media Area	Replacement Media	Resistance @ Airflow Volume (Inches w.c. @CFM)		Shipping Weight (full carton)	Filtering Media Area		
Model 1110	16 x 20	13 lbs.	Ships With	Model 110	.06"@600 .10"@800	.14"@1000 .20"@1200	18 lbs.	22.2 sq. ft.	Also Uses	Model 113	.11"@600 .16"@800	.22"@1000 .29"@1200	18 lbs.	22.2 sq. ft.
Model 1210	20 x 25	18 lbs.		Model 210	.04"@600 .06"@800 .08"@1000 .11"@1200	.13"@1400 .16"@1600 .19"@1800 .22"@2000	25 lbs.	28 sq. ft.		Model 213	.06"@600 .09"@800 .12"@1000 .15"@1200	.19"@1400 .23"@1600 .27"@1800 .31"@2000	25 lbs.	28 sq. ft.
Model 1310	20 x 20	15 lbs.		Model 310	.06"@600 .10"@800	.14"@1000 .19"@1200	19 lbs.	21.3 sq. ft.		Model 313	.09"@600 .13"@800	.17"@1000 .23"@1200	19 lbs.	21.3 sq. ft.
Model 1410	16 x 25	17 lbs.		Model 410	.05"@600 .07"@800 .09"@1000 .12"@1200	.15"@1400 .19"@1600 .22"@1800 .27"@2000	22 lbs.	24.5 sq. ft.		Model 413	.07"@600 .10"@800 .14"@1000 .17"@1200	.22"@1400 .26"@1600 .31"@1800 .37"@2000	22 lbs.	24.5 sq. ft.

REMOVAL EFFICIENCY (Based on Particle Size)

	0.3-1.0 Microns	1.0-3.0 Microns	3.0-10 Microns
MERV 11	37%	67%	92%
MERV 13	63%	88%	93%

Inlet Side Return Duct Connection

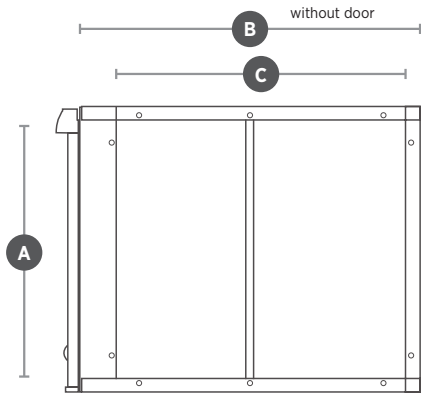

Front



Outlet Side Furnace Connection

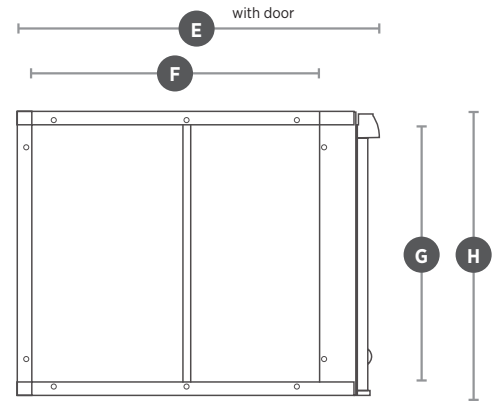

Dim.	Description	Model			
		1110	1210	1310	1410
A	Inlet Opening Height	15 7/16" (392mm)	19 3/4" (502mm)	18 1/16" (459mm)	15 7/16" (392mm)
B	Outer Housing Depth without Door	20 1/16" (509.5mm)	25 3/8" (645mm)	20 1/16" (509.5mm)	28 1/16" (713mm)
C	Inlet Opening Width	17 3/8" (441mm)	21 3/16" (538mm)	15 7/8" (403mm)	23 7/8" (606mm)
D	Unit Width	6 3/4" (171mm)	6 3/4" (171mm)	6 3/4" (171mm)	6 3/4" (171mm)
E	Outer Housing Depth with Door	22 1/16" (560mm)	27 3/8" (695mm)	22 1/16" (560mm)	30 1/16" (763mm)
F	Outlet Opening Width	17 3/8" (441mm)	21 3/16" (538mm)	15 7/8" (403mm)	23 7/8" (606mm)
G	Outlet Opening Height	15 7/16" (392mm)	19 3/4" (502mm)	18 1/16" (459mm)	15 7/16" (392mm)
H	Unit Height	17 3/4" (451mm)	22 1/16" (560mm)	20 3/8" (518mm)	17 3/4" (451mm)

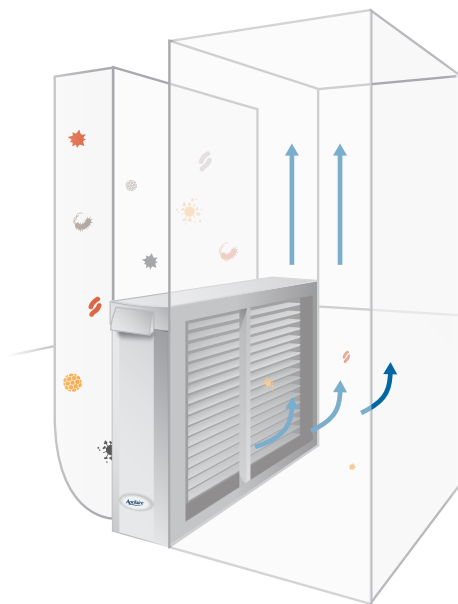

Same protection is recommended for all HVAC types. Including downflow, upflow and horizontal configurations.

REPLACEMENT MEDIA		
Model 1110	Aprilaire Part No. 110 Aprilaire Part No. 113	MERV 11 MERV 13
Model 1210	Aprilaire Part No. 210 Aprilaire Part No. 213	MERV 11 MERV 13
Model 1310	Aprilaire Part No. 310 Aprilaire Part No. 313	MERV 11 MERV 13
Model 1410	Aprilaire Part No. 410 Aprilaire Part No. 413	MERV 11 MERV 13