



aerospace
climate control
electromechanical
filtration
fluid & gas handling
hydraulics
pneumatics
process control
sealing & shielding



ZoomLock[®] MAX

PRESS-TO-CONNECT REFRIGERANT FITTINGS

ZoomLock[®] MAX

Press-to-Connect Refrigerant Fittings

Catalog K-3, Engineering Submittal, June 2021



ENGINEERING YOUR SUCCESS.

PARKER SAFETY GUIDE FOR SELECTING AND USING ZOOMLOCK MAX FITTINGS AND RELATED ACCESSORIES

WARNING

FAILURE TO FOLLOW INSTALLATION INSTRUCTIONS, IMPROPER SELECTION OR IMPROPER USE OF ZOOMLOCK MAX FITTINGS AND RELATED ACCESSORIES (“PRODUCTS”) CAN CAUSE DEATH, PERSONAL INJURY AND PROPERTY DAMAGE. POSSIBLE CONSEQUENCES OF FAILURE, IMPROPER SELECTION OR IMPROPER USE OF THESE PRODUCTS INCLUDE BUT ARE NOT LIMITED TO:

- Fittings thrown off at high speed.
- High velocity fluid discharge.
- Explosion or burning of the conveyed fluid.
- Electrocutation from high voltage electric power lines.
- Contact with suddenly moving or falling objects that are controlled by the conveyed fluid.
- Injections by high-pressure fluid discharge.
- Dangerously whipping copper line.
- Contact with conveyed fluids that may be hot, cold, toxic or otherwise injurious.
- Sparking or explosion caused by static electricity buildup or other sources of electricity.
- Sparking or explosion from flammable liquids.

ZOOMLOCK MAX FITTINGS CAN ONLY BE CONNECTED WITH JAWS/TOOLS DESIGNED FOR USE WITH ZOOMLOCK MAX PRODUCTS. BEFORE SELECTING OR USING ANY OF THESE PRODUCTS, IT IS IMPORTANT THAT YOU READ AND FOLLOW THE INSTALLATION INSTRUCTIONS.

KEY STEPS FOR SAFETY

ZoomLock MAX fittings are intended to be installed by HVAC/R professionals that have been trained specifically on ZoomLock MAX products. For product training visit www.zoomlocktraining.com.

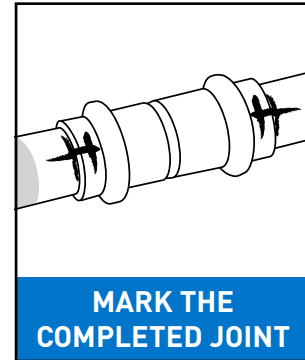
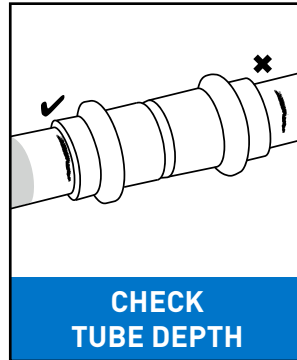
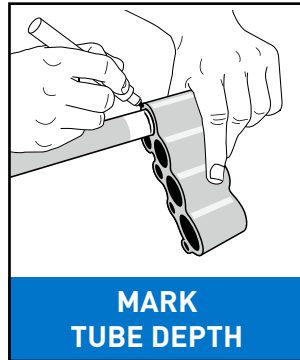
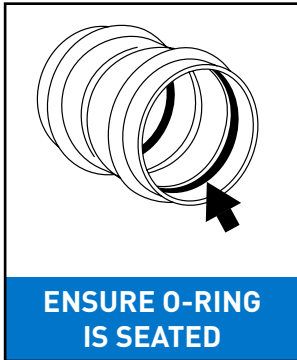

WARNING – USER RESPONSIBILITY

Failure or improper selection or improper use of the products described herein or related items can cause death, personal injury and property damage.

This document and other information from Parker Hannifin Corporation, its subsidiaries and authorized distributors provide product or system options for further investigation by users having technical expertise.

The user, through its own analysis and testing, is solely responsible for making the final selection of the system and components and assuring that all performance, endurance, maintenance, safety and warning requirements of the application are met. The user must analyze all aspects of the application, follow applicable industry standards, and follow the information concerning the product in the current product catalog and in any other materials provided from Parker or its subsidiaries or authorized distributors.

To the extent that Parker or its subsidiaries or authorized distributors provide component or system options based upon data or specifications provided by the user, the user is responsible for determining that such data and specifications are suitable and sufficient for all applications and reasonably foreseeable uses of the components or systems.

For safety information see the Safety Guide at www.parker.com/safety or call 1-800-CParker.

OFFER OF SALE

The items described in this document are hereby offered for sale by Parker Hannifin Corporation, its subsidiaries or its authorized distributors. This offer and its acceptance are governed by the provisions stated in the detailed “Offer of Sale” elsewhere in this document or available at www.parker.com.

Catalog K-3, June 2021 supersedes Catalog K-3, May 2021 and all prior publications.

ZoomLock MAX

Press-to-Connect Refrigerant Fittings

TABLE OF CONTENTS

Introduction	4
Features and Benefits	5
Technical Data	6
Press Tools and Jaws.....	7
Press-to-Connect Refrigerant Fittings	
Couplings	9
Slip Couplings.....	9
Reducers.....	10
Caps	10
90° Elbows	11
90° Long Radius Elbows.....	11
90° Street Elbows.....	12
45° Elbows	12
Tees.....	13
SAE Flares.....	13
P-Traps	14
Y-Joints.....	14
Installation Kit.....	14
Depth Gauge	14
Fitting Storage	15
Marking and Cleanliness	15
Design Consideration.....	15
Installation Instructions	20
Frequently Asked Questions	23
Abbreviations	25
Terms of Sale with Warranty Limitations	26

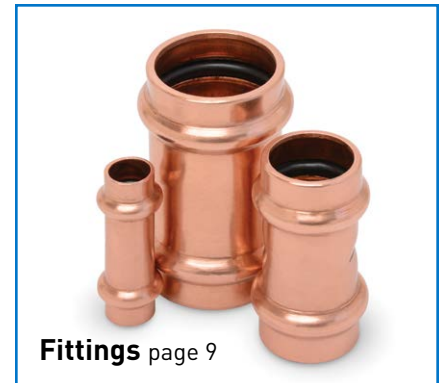

Fittings page 9



Press Tools page 7



Jaws page 8

Compatible Components

To make a system convenient to install, ODM x ODM ZoomLock compatible components are available including:

- Ball Valves
- Moisture and Liquid Indicators
- Solenoid Valves
- Filter-Driers



ATTENTION!

WARRANTY COULD BE VOID IF ZOOMLOCK MAX IS NOT APPLIED PER INSTRUCTIONS! CAREFULLY READ ALL INSTALLATION INSTRUCTIONS (SEE PAGES 20-22) AND WATCH VIDEOS.



ZoomLockMAX.com

*Connect Copper in Seconds,
Improves Profitability for HVACR Companies*



Rated up to
700 psi
48 bar

ZoomLock[®]
MAX

PRESS-TO-CONNECT REFRIGERANT FITTINGS

ZoomLock[®] MAX fittings, designed for the air conditioning and refrigeration markets, allow contractors to make secure leak-free connections in seconds. It means less time on the job and more money in the contractor's pocket.

ZoomLock MAX fittings provide clean, leak-proof connections for refrigerant lines up to 700 psi. By eliminating concerns about gas and flames, ZoomLock MAX fittings offer more flexibility in where and when you can work, plus there's no need to nitrogen-purge the lines.

The ZoomLock MAX Advantage

- Hermetically sealed packaging for debris-free fittings
- Hard, robust copper fittings made from refrigerant grade copper
- Proven three-point press technology providing a leak-free and secure joint
- No more crimp gauge needed—connect the fitting with one complete cycle
- Jaws available for most professional crimping tool brands, both large and compact



HELPING YOUR BUSINESS WIN MORE BUSINESS™

ZoomLock MAX

Press-to-Connect Refrigerant Fittings

FEATURES AND BENEFITS

- **Flame-free:**
Flame-free installation avoids the need for a fire permit and the risk of fire on site.
- **No Nitrogen Purge:**
ZoomLock MAX is a mechanical joint, thus eliminating the need for nitrogen purge during the jointing process.
- **Lower Installed Cost:**
A professional fitting which is quick and simple to install, saving time and money.
- **Higher Productivity, Improved Flexibility:**
Work may be completed during working hours / public access, by a single employee.
- **Site Access:**
Easy access to work sites, no gas bottles required.
- **Quality Designed In:**
Reliable, repeatable, permanent, tamper-proof connections every time.
- **3-Point Press:**
Three press points, one each side of the bead, and one press compressing the O-ring. This provides a secure joint.
- **High Quality O-ring:**
High quality HNBR O-ring forms a secure leak-free joint when pressed.
- **Protected O-ring:**
Lead-in edge design aids tube insertion and helps protect the O-ring from damage or displacement.
- **Electrical Continuity:**
Maintains ground continuity without the need for additional ground continuity straps.
- **Field Proven:**
Press fit technology, field proven over two decades and millions of installed fittings worldwide.
- **Compact Tooling:**
Light compact tooling provides easy access to tightly spaced tube runs.
- **Tooling Concept:**
Only specially designed ROTHENBERGER jaws are approved for use with ZoomLock MAX fittings.
- **Certification:**
ZoomLock MAX is UL listed, refrigerant fitting SA7511.
ZoomLock MAX is UL listed, approved use for field and factory installations.
- **Support:**
Backed by ZoomLock's experienced technical support and customer service teams.



Applications

ZoomLock MAX fittings are designed for the following applications:

- Refrigeration
- Air Conditioning
- Heat Pump (Refrigeration side)
- VRF and VRV



ZoomLock MAX

Press-to-Connect Refrigerant Fittings

TECHNICAL DATA

Product Parameters

- **Applications:**
 - Refrigeration
 - Air Conditioning
 - Heat Pump (Refrigeration side)
 - VRF and VRV
- **Continuous Operating Temperature:**
-40°F to 250°F / -40°C to 121°C
- **O-ring Temperature Range:**
-40°F to 284°F / -40°C to 140°C
- **Maximum Rated Operating and Abnormal Pressure:**
700 psi / 48 bar / 4800 kPa
- **Burst Pressure:**
>3X Maximum operating and abnormal pressure
>2,100 psig / >14400 kPa / >144 bar
- **Vacuum Pressure Capability:**
200 Microns
- **Leak Tightness:**
Helium $\leq 7.5 \times 10^{-7}$ Pa.m³/s at +20°C, 10 bar
- **Size Availability (Inches):**
1/4, 3/8, 1/2, 5/8, 3/4, 7/8, 1-1/8, 1-3/8

Agency Approvals and Certifications

- UL Listed Refrigerant fitting SA7511
- UL Listed: Approved use for field and factory installations
- UL 109 - 7 Pull test, compliant
- UL 109 - 8 Vibration test, compliant
- UL 1963 - 79 Tests of gaskets and seals used in refrigerant systems, compliant
- ISO 5149-2:2014, Refrigerating systems and heat pumps - Safety and environmental requirements - Part 2: Design, construction, testing, marking and documentation compliant
- ISO 5149-2, 5.3.2.2.3 Strength pressure test, compliant
- ISO 14903 - 7.4 Tightness test, compliant
- ISO 14903 - 7.6 Pressure temperature vibration tests (PTV), compliant
- ISO 14903 - 7.8 Freezing test, compliant
- ASTM G85 salt spray (fog) compliant
- ASHRAE 15 - 2016 Safety Standard for Refrigeration Systems, compliant
- ASME B31.5 - 2016 Refrigeration Piping and Heat Transfer Components, compliant
- 2018, 2015, 2012, 2009 and 2006 International Mechanical Code (IMC), certified, ICC-ES, PMG-1440
- 2018, 2015, 2012, 2009 and 2006 International Residential Code (IRC), certified, ICC-ES, PMG-1440
- 2018, 2015, 2012, 2009 and 2006 Uniform Mechanical Code (UMC), certified, ICC-ES, PMG-1440

Mechanical joints shall not be used on annealed temper copper tube in sizes larger than 7/8 inch (22.2 mm) OD size per International Mechanical Code (IMC) and 3/4 inch nominal size per Uniform Mechanical Code (UMC).

Fitting Materials

- **Fitting Body:**
Refrigerant Grade Copper
(UNS C12200 min 99.9% pure)
- **O-Ring:**
HNBR

Fitting Warranty

- 10-year warranty. Refer to page 26 for more details.

Compatibility

- **Approved Lubricants:** POE, PAO, PVE, AB and MO
- **Approved Connections:**
Copper to Copper
- **Approved Tube:**
Copper tube conforming to ASTM B280, ASTM B88, or ASTM B743
- **Approved Copper Tubing:**
Hard Copper (Drawn)
- Type ACR, L, K

Soft Copper (Annealed)
- Type ACR, L, K

Approved Refrigerants

32**	422D	454A**
125	427A	454B**
134a	438A	454C**
290**	444A**	457A**
404A	447A**	459A**
407A	447B**	507A
407C	448A	513A
407F	449A	513B
407H	450A	600A**
410A	452A	718
417A	452B**	1234yf**
421A	452C	1234ze**
422B	HYCOOL 20	

* Please refer to ZoomLock MAX Tube Compatibility Table, page 18.

** When using refrigerants classified A2L (lower flammability), A2 (flammable) and A3 (higher flammability) additional specific standards, local rules and regulations, codes of practice and by-laws may be applicable.

ZoomLock MAX fittings are NOT suitable for R-717, R-723, R-764, R-744 refrigerants. Refer to ZoomLockMAX.com for the latest approved refrigerants list.

ZoomLock MAX



Quality Assurance

ZoomLock MAX is manufactured in an ISO 9001 certified facility committed to providing quality products and support.

ZoomLock MAX

Press-to-Connect Refrigerant Fittings

PRESS TOOLS AND JAWS

Parker Hannifin recommends the use of ROTHENBERGER press tools in combination with ZoomLock MAX ROTHENBERGER jaws. However other press tools may be used in combination with ZoomLock MAX ROTHENBERGER jaws. See table below for tool compatibility.

Press Tools

ROTHENBERGER ROMAX 4000

Includes the ROTHENBERGER ROMAX® 32 kN press tool, 2 batteries and battery charger.

- **Description:** MZK-TK-R4000
- **Part Number:** 871441

ROTHENBERGER Twin Turbo US

Includes the ROTHENBERGER Twin Turbo US 24 kN press tool, 2 batteries and battery charger.

- **Description:** MZK-TK-RCTT
- **Part Number:** 871439



ROTHENBERGER ROMAX 4000 32 kN



ROTHENBERGER Twin Turbo US 24 kN

COMPATIBLE PRESS TOOLS		32 kN	24 kN	19 kN
ROTHENBERGER	ROMAX® 3000	✓	—	—
	ROMAX® 3000 AC	✓	—	—
	ROMAX® 4000	✓	—	—
	ROMAX® AC ECO	✓	—	—
	Twin Turbo US (TT US)	—	✓	—
	ROMAX® Compact TT	—	—	✓
	ROMAX® Compact	—	—	✓
DEWALT	DCE200	✓	—	—
KLAUKE	UAP2/UNP2	✓	—	—
	UAP3L/UAP4L	✓	—	—
	UP2EL14	✓	—	—
	MAP2L19	—	—	✓
	MAP219	—	—	✓
MILWAUKEE	M12 Force Logic	—	✓	—
	M18 Force Logic	✓	—	—
HILTI	NPR 019	—	—	✓
NIBCO	PC-100	✓	—	—
	PC-280	✓	—	—
REMS	Power-Press	✓	—	—
	Akku-Press	✓	—	—
RIDGID	320-E	✓	—	—
	CT400	✓	—	—
	RP 241	—	✓	—
	RP 240	—	✓	—
	RP 210-B	—	✓	—
	RP 200-B	—	✓	—
	RP 330-B	✓	—	—
	RP 330-C	✓	—	—
	RP 340	✓	—	—
VIRAX	Viper® P25+	✓	—	—
	Viper® P25+	✓	—	—

ZoomLock MAX fittings can only be connected with jaws designed for use with ZoomLock MAX products as shown on page 8.

ZoomLock MAX

Press-to-Connect Refrigerant Fittings

PRESS TOOLS AND JAWS (Continued)

Jaws



**32 kN
ROTHENBERGER
Jaw Set**



**24 kN
ROTHENBERGER
Jaw Set**



**19 kN
ROTHENBERGER
Jaw Set**

JAW SETS / PART NUMBERS

Jaw Sets

7 Piece
1/4, 3/8, 1/2, 5/8,
3/4, 7/8, 1-1/8

MZK-32KN JAW KIT (7 PIECE)
871408

MZK-24KN JAW KIT (7 PIECE)
871409

MZK-19KN JAW KIT (7 PIECE)
871410

INDIVIDUAL JAWS / PART NUMBERS

1/4"	MZK-32KN JAW-1/4" 871428	MZK-24KN JAW-1/4" 871419	MZK-19KN JAW-1/4" 871411
3/8"	MZK-32KN JAW-3/8" 871429	MZK-24KN JAW-3/8" 871420	MZK-19KN JAW-3/8" 871412
1/2"	MZK-32KN JAW-1/2" 871430	MZK-24KN JAW-1/2" 871421	MZK-19KN JAW-1/2" 871413
5/8"	MZK-32KN JAW-5/8" 871431	MZK-24KN JAW-5/8" 871422	MZK-19KN JAW-5/8" 871414
3/4"	MZK-32KN JAW-3/4" 871432	MZK-24KN JAW-3/4" 871423	MZK-19KN JAW-3/4" 871415
7/8"	MZK-32KN JAW-7/8" 871433	MZK-24KN JAW-7/8" 871424	MZK-19KN JAW-7/8" 871416
1-1/8"	MZK-32KN JAW-1 1/8" 871435	MZK-24KN JAW-1 1/8" 871426	MZK-19KN JAW-1 1/8" 871418
1-3/8"*	MZK-32KN JAW-1 3/8" 871436	—	—

*Depth gauge (P/N 870517) is included with the 1-3/8" jaw.



WARNING: ZoomLock MAX fittings can only be connected with jaws/tools designed for use with ZoomLock MAX products.

ZoomLock MAX

Press-to-Connect Refrigerant Fittings

COUPLINGS



Dimensions

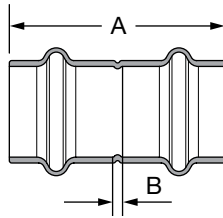

Size	Part Number	Description	Dimensions			
			A		B	
			Inch	mm	Inch	mm
1/4	870508	MZK-C4-HNBR	1.54	39.0	0.12	3.0
3/8	870509	MZK-C6-HNBR	1.50	38.0	0.12	3.0
1/2	870503	MZK-C8-HNBR	1.57	40.0	0.20	5.0
5/8	870510	MZK-C10-HNBR	1.77	45.0	0.12	3.0
3/4	870505	MZK-C12-HNBR	1.79	45.5	0.06	1.5
7/8	870506	MZK-C14-HNBR	2.22	56.5	0.33	8.5
1-1/8	870507	MZK-C18-HNBR	2.24	57.0	0.24	6.0
1-3/8	870511	MZK-C22-HNBR	2.80	71.0	0.11	3.0

SLIP COUPLINGS



Dimensions

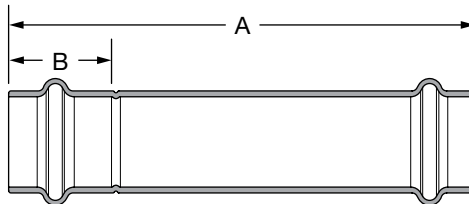

Size	Part Number	Description	Dimensions			
			A		B	
			Inch	mm	Inch	mm
1/4	870550	MZK-RC4-HNBR	3.54	90.0	0.71	18.0
3/8	870552	MZK-RC6-HNBR	3.54	90.0	0.71	18.0
1/2	870553	MZK-RC8-HNBR	3.58	91.0	0.69	17.5
5/8	870554	MZK-RC10-HNBR	3.98	101	0.83	21.0
3/4	870555	MZK-RC12-HNBR	3.98	101	0.86	22.0
7/8	870556	MZK-RC14-HNBR	4.17	106	0.95	24.0
1-1/8	870557	MZK-RC18-HNBR	4.17	106	1.00	25.5
1-3/8	870559	MZK-RC22-HNBR	3.94	100	1.34	34.0

ZoomLock MAX

Press-to-Connect Refrigerant Fittings

REDUCERS



Dimensions

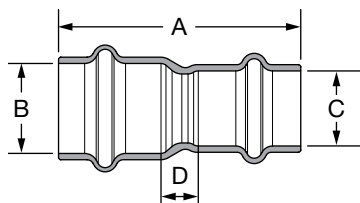

Size	Part Number	Description	Dimensions							
			A		B		C		D	
			Inch	mm	Inch	mm	Inch	mm	Inch	mm
3/8 x 1/4	870800	MZK-R64-HNBR	1.65	42.0	3/8	9.53	1/4	6.35	0.24	6.0
1/2 x 1/4	870808	MZK-R84-HNBR	1.73	44.0	1/2	12.7	1/4	6.35	0.33	8.5
1/2 x 3/8	870801	MZK-R86-HNBR	1.67	42.5	1/2	12.7	3/8	9.53	0.28	7.0
5/8 x 1/4	870809	MZK-R104-HNBR	2.05	52.0	5/8	15.9	1/4	6.35	0.51	13.0
5/8 x 3/8	870810	MZK-R106-HNBR	1.87	47.5	5/8	15.9	3/8	9.53	0.33	8.5
5/8 x 1/2	870802	MZK-R108-HNBR	1.79	45.5	5/8	15.9	1/2	12.7	0.28	7.0
3/4 x 1/2	870811	MZK-R128-HNBR	1.81	46.0	3/4	19.1	1/2	12.7	0.26	6.5
3/4 x 5/8	870803	MZK-R1210-HNBR	2.07	52.5	3/4	19.1	5/8	15.9	0.37	9.5
7/8 x 1/2	870812	MZK-R148-HNBR	2.07	52.5	7/8	22.2	1/2	12.7	0.43	11.0
7/8 x 5/8	870804	MZK-R1410-HNBR	2.07	52.5	7/8	22.2	5/8	15.9	0.30	7.5
7/8 x 3/4	870805	MZK-R1412-HNBR	2.07	52.5	7/8	22.2	3/4	19.1	0.26	6.5
1-1/8 x 5/8	870814	MZK-R1810-HNBR	2.17	55.0	1-1/8	28.6	5/8	15.9	0.33	8.5
1-1/8 x 3/4	870806	MZK-R1812-HNBR	2.26	57.5	1-1/8	28.6	3/4	19.1	0.39	10.0
1-1/8 x 7/8	870807	MZK-R1814-HNBR	2.28	58.0	1-1/8	28.6	7/8	22.2	0.33	8.5
1-3/8 x 7/8	870815	MZK-R2214-HNBR	2.63	67.0	1-3/8	34.9	7/8	22.2	0.51	13.0
1-3/8 x 1-1/8	870816	MZK-R2218-HNBR	2.83	72.0	1-3/8	34.9	1-1/8	28.6	0.49	12.5

CAPS



Dimensions

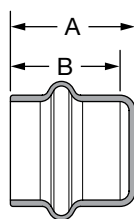

Size	Part Number	Description	Dimensions			
			A		B	
			Inch	mm	Inch	mm
1/4	870900	MZK-CP4-HNBR	0.77	19.5	0.71	18.0
3/8	870902	MZK-CP6-HNBR	0.77	19.5	0.71	18.0
1/2	870903	MZK-CP8-HNBR	0.75	19.0	0.69	17.5
5/8	870904	MZK-CP10-HNBR	0.89	22.5	0.83	21.0
3/4	870905	MZK-CP12-HNBR	0.93	23.5	0.87	22.0
7/8	870906	MZK-CP14-HNBR	1.02	26.0	0.94	24.0
1-1/8	870907	MZK-CP18-HNBR	1.08	27.5	1.00	25.5
1-3/8	870908	MZK-CP22-HNBR	1.47	37.5	1.34	34.0

ZoomLock MAX

Press-to-Connect Refrigerant Fittings

90° ELBOWS



Dimensions

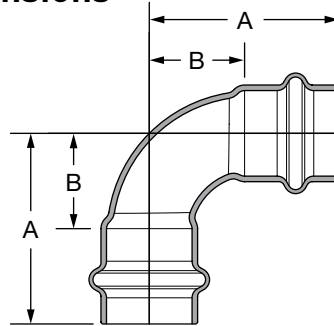

Size	Part Number	Description	Dimensions			
			A		B	
			Inch	mm	Inch	mm
1/4	870600	MZK-90E4-HNBR	1.28	32.5	0.57	14.5
3/8	870602	MZK-90E6-HNBR	1.30	33.0	0.59	15.0
1/2	870603	MZK-90E8-HNBR	1.24	31.5	0.55	14.0
5/8	870604	MZK-90E10-HNBR	1.54	39.0	0.71	18.0
3/4	870605	MZK-90E12-HNBR	1.67	42.5	0.81	20.5
7/8	870606	MZK-90E14-HNBR	1.97	50.0	1.02	26.0
1-1/8	870607	MZK-90E18-HNBR	2.24	57.0	1.24	31.5
1-3/8	870608	MZK-90E22-HNBR	2.72	69.0	1.38	35.0

90° LONG RADIUS ELBOWS

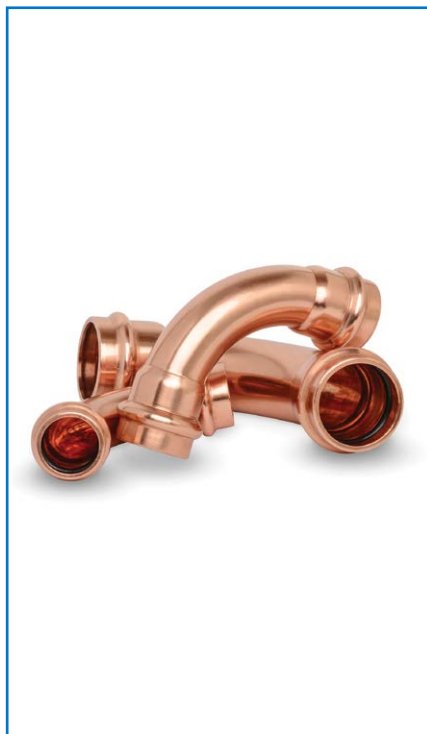

Dimensions

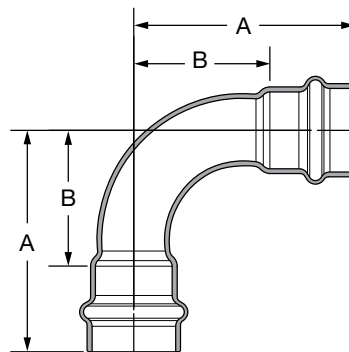

Size	Part Number	Description	Dimensions			
			A		B	
			Inch	mm	Inch	mm
1/2	871613	MZK-90E8-LR-HNBR	1.71	43.5	1.02	26.0
5/8	871614	MZK-90E10-LR-HNBR	1.96	50.0	1.14	29.0
3/4	871610	MZK-90E12-LR-HNBR	2.20	56.0	1.33	34.0
7/8	871611	MZK-90E14-LR-HNBR	2.59	66.0	1.65	42.0
1-1/8	871612	MZK-90E18-LR-HNBR	3.03	77.0	2.02	51.5
1-3/8	871615	MZK-90E22-LR-HNBR	3.50	89.0	2.15	54.7

ZoomLock MAX

Press-to-Connect Refrigerant Fittings

90° STREET ELBOWS



Dimensions

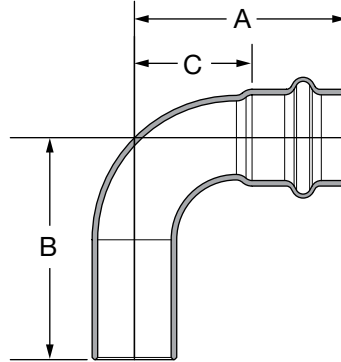

Size	Part Number	Description	Dimensions					
			A		B		C	
			Inch	mm	Inch	mm	Inch	mm
3/8	871302	MZK-90SE6-HNBR	1.30	33.0	1.36	34.5	0.59	15.0
1/2	871303	MZK-90SE8-HNBR	1.24	31.5	1.36	34.5	0.55	14.0
5/8	871304	MZK-90SE10-HNBR	1.54	39.0	1.77	45.0	0.71	18.0
3/4	871305	MZK-90SE12-HNBR	1.67	42.5	1.89	48.0	0.81	20.5
7/8	871306	MZK-90SE14-HNBR	1.97	50.0	2.09	53.0	1.02	26.0
1-1/8	871307	MZK-90SE18-HNBR	2.24	57.0	2.42	61.5	1.24	31.5
1-3/8	871308	MZK-90SE22-HNBR	2.72	69.0	3.22	82.0	1.38	35.0

45° ELBOWS



Dimensions

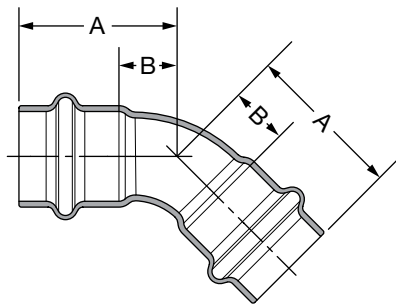

Size	Part Number	Description	Dimensions			
			A		B	
			Inch	mm	Inch	mm
1/4	871401	MZK-45E4-HNBR	0.93	23.5	0.22	5.5
3/8	871402	MZK-45E6-HNBR	1.02	26.0	0.31	8.0
1/2	871403	MZK-45E8-HNBR	0.94	24.0	0.26	6.5
5/8	871404	MZK-45E10-HNBR	1.10	28.0	0.28	7.0
3/4	871405	MZK-45E12-HNBR	1.24	31.5	0.37	9.5
7/8	871406	MZK-45E14-HNBR	1.34	34.0	0.39	10.0
1-1/8	871407	MZK-45E18-HNBR	1.56	39.5	0.55	14.0
1-3/8	871399	MZK-45E22-HNBR	2.02	52.0	0.71	18.0

ZoomLock MAX

Press-to-Connect Refrigerant Fittings

TEES



Dimensions

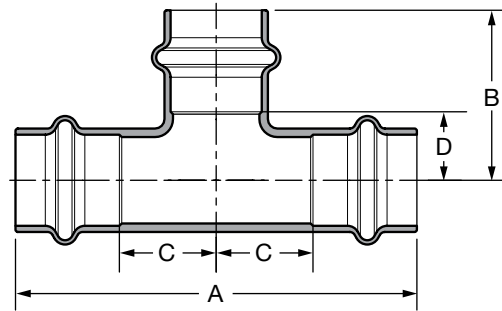

Size	Part Number	Description	Dimensions							
			A		B		C		D	
			Inch	mm	Inch	mm	Inch	mm	Inch	mm
1/4	870701	MZK-T4-HNBR	2.13	54.0	1.06	27.0	0.35	9.0	0.35	9.0
3/8	870702	MZK-T6-HNBR	2.48	63.0	1.22	31.0	0.53	13.5	0.51	13.0
1/2	870703	MZK-T8-HNBR	2.60	66.0	1.10	28.0	0.61	15.5	0.41	10.5
5/8	870704	MZK-T10-HNBR	2.99	76.0	1.26	32.0	0.67	17.0	0.43	11.0
3/4	870705	MZK-T12-HNBR	3.31	84.0	1.42	36.0	0.79	20.0	0.55	14.0
7/8	870706	MZK-T14-HNBR	3.50	89.0	1.52	38.5	0.81	20.5	0.57	14.5
1-1/8	870707	MZK-T18-HNBR	3.74	95.0	1.69	43.0	0.87	22.0	0.69	17.5
1-3/8	870708	MZK-T22-HNBR	4.41	112	2.20	56.0	0.87	22.0	0.87	22.0

SAE FLARES



Dimensions

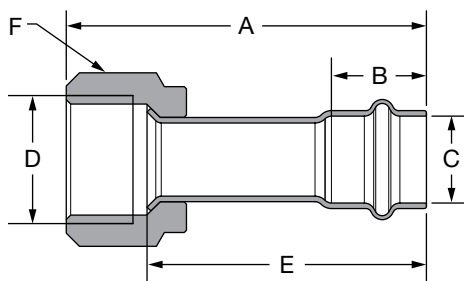

Size	Part Number	Description	Dimensions									
			A		B		C	D	E		F	
			Inch	mm	Inch	mm	Inch	Inch	Inch	mm	Inch	mm
1/4	871000	MZK-F4-HNBR	2.13	54.0	0.71	18.0	1/4"	1/4"	1.81	46.0	0.67	17.0
3/8	871002	MZK-F6-HNBR	2.40	61.0	0.71	18.0	3/8"	3/8"	1.97	50.0	0.86	22.0
1/2	871003	MZK-F8-HNBR	2.50	63.5	0.69	17.5	1/2"	1/2"	2.03	51.5	0.95	24.0
5/8	871004	MZK-F10-HNBR	2.91	74.0	0.83	21.0	5/8"	5/8"	2.28	58.0	1.06	27.0
3/4	871005	MZK-F12-HNBR	3.21	81.5	0.86	22.0	3/4"	3/4"	2.50	63.5	1.34	34.0

ZoomLock MAX

Press-to-Connect Refrigerant Fittings

Y-JOINTS

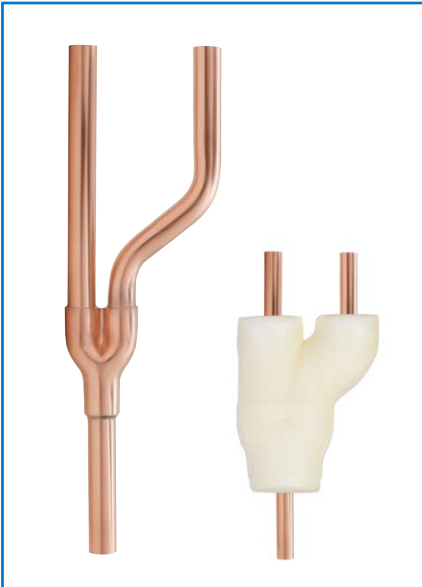

Dimensions

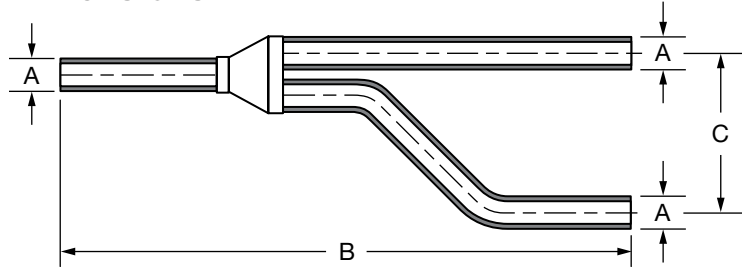

Size	Part Number	Description	Dimensions					
			A		B		C	
			Inch	mm	Inch	mm	Inch	mm
3/8	771102	MZK-Y6-NA	0.38	9.5	7.59	192	2.37	60.0
1/2	771103	MZK-Y8-NA	0.50	12.7	8.97	227	2.49	63.0
5/8	771104	MZK-Y10-NA	0.63	15.9	9.49	240	2.61	66.0
3/4	771105	MZK-Y12-NA	0.75	19.1	10.20	258	2.73	69.0
7/8	771106	MZK-Y14-NA	0.88	22.2	12.13	307	2.89	73.0
1-1/8	771107	MZK-Y18-NA	1.13	28.6	13.16	333	3.56	90.0

Note: Not UL Approved. Includes foam insulation as shown.

P-TRAPS

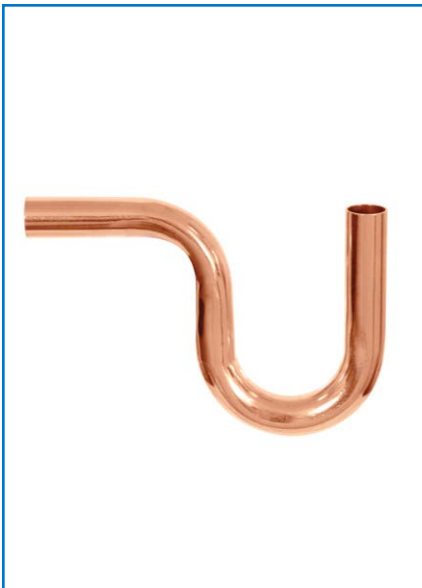

Dimensions

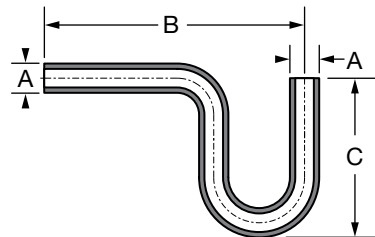

Size	Part Number	Description	Dimensions					
			A		B		C	
			Inch	mm	Inch	mm	Inch	mm
1/2	771203	MZK-PT8-NA	0.50	12.7	5.12	130	3.54	90.0
5/8	771204	MZK-PT10-NA	0.63	15.9	5.12	130	3.62	92.0
3/4	771205	MZK-PT12-NA	0.75	19.1	5.91	150	4.25	108.0
7/8	771206	MZK-PT14-NA	0.88	22.2	6.69	170	4.65	118.0
1-1/8	771207	MZK-PT18-NA	1.13	28.6	8.27	210	5.98	152.0
1-3/8	771208	MZK-PT22-NA	1.38	34.9	10.24	260	7.48	190.0

INSTALLATION KIT

3 piece kit includes depth gauge for sizes 1/4" through 1-1/8", permanent marker, and general purpose hand pad. Depth gauge for 1-3/8" fitting size sold separately.

■ **Description:** MZK-IK, **Part Number:** 870516

DEPTH GAUGE

Plastic depth gauge confirms the proper insertion depth of the tubing. For use with 1-3/8" fitting size only.

■ **Description:** MZK-IK-22 Install Kit 1-3/8, **Part Number:** 870517



ZoomLock MAX

Press-to-Connect Refrigerant Fittings

FITTING STORAGE

ZoomLock MAX fittings do not require special storage conditions. However to protect the HNBR O-ring a few simple precautions should be taken.

The O-rings should be protected from light sources, in particular direct sunlight or intense artificial light having a high ultra-violet content.

As the ozone is particularly harmful to rubber, storage rooms should not contain any equipment that is capable of generating ozone, such as mercury vapor lamps or high-voltage electrical equipment giving rise to electric sparks or silent electrical discharges.

Combustion gases and organic vapors should be excluded from storage rooms, as they may give rise to ozone via photochemical processes. Precautions should also be taken to protect stored products from all sources of ionizing radiation.

ZoomLock MAX fittings should be kept in their sealed bags to protect them from contamination.

MARKINGS and CLEANLINESS

Each fitting is marked ZoomLock MAX, size and 48 bar (on a pink background) and are cleaned, bagged and labeled to fully comply with the cleanliness requirements of ASTM-B280 and ASTM-B88 type K or L. Keep the ziplock bag sealed to protect fittings from contamination.

DESIGN CONSIDERATIONS

All refrigeration pipelines must be designed so that the number of joints is kept to a practical minimum. Refrigeration pipelines should be designed in compliance with the following key standards and in line with federal, state and local regulations, codes of practice and by-laws governing the installation. All applicable health and safety practices must be adhered to.

- ASHRAE 15 - 2016 Safety Standard for Refrigeration Systems.
- ASME B31.5 - 2016 Refrigeration Piping and Heat Transfer Components.
- 2018, 2015, 2012, 2009 and 2006 International Mechanical Code (IMC).
- 2018, 2015, 2012, 2009 and 2006 International Residential Code (IRC).
- 2018, 2015, 2012, 2009 and 2006 Uniform Mechanical Code (UMC).

Pipework Support

All pipework should be supported by the use of appropriate clips, brackets or supports. Please refer to:

- ASHRAE 15 - 2016 Safety Standard for Refrigeration Systems.
- ASME B31.5 - 2016 Refrigeration Piping and Heat Transfer Components.
- 2018, 2015, 2012, 2009 and 2006 International Mechanical Code (IMC).
- 2018, 2015, 2012, 2009 and 2006 International Residential Code (IRC).
- 2018, 2015, 2012, 2009 and 2006 Uniform Mechanical Code (UMC).

Federal, state and local regulations, codes of practice and by-laws governing the installation must also be adhered to. Supports should be placed near to fittings when possible and additional supports may be required when using soft copper tubes or where vibration occurs.

Pipework Protection

Tubing and fittings shall be protected as far as possible against adverse environmental or other external effects. Refer to:

- ASHRAE 15 - 2016 Safety Standard for Refrigeration Systems.
- ASME B31.5 - 2016 Refrigeration Piping and Heat Transfer Components.
- 2018, 2015, 2012, 2009 and 2006 International Mechanical Code (IMC).
- 2018, 2015, 2012, 2009 and 2006 International Residential Code (IRC).
- 2018, 2015, 2012, 2009 and 2006 Uniform Mechanical Code (UMC).

Federal, state and local regulations, codes of practice and by-laws governing the installation must also be adhered to.

Pipework Identification and Insulation

All pipework must be installed in accordance with:

- ASHRAE 15 - 2016 Safety Standard for Refrigeration Systems.

Electrical Continuity

ZoomLock MAX fittings maintain ground continuity without the need for additional ground continuity straps.

ZoomLock MAX

Press-to-Connect Refrigerant Fittings

DESIGN CONSIDERATIONS (Continued)

Space Required for the Pressing Process

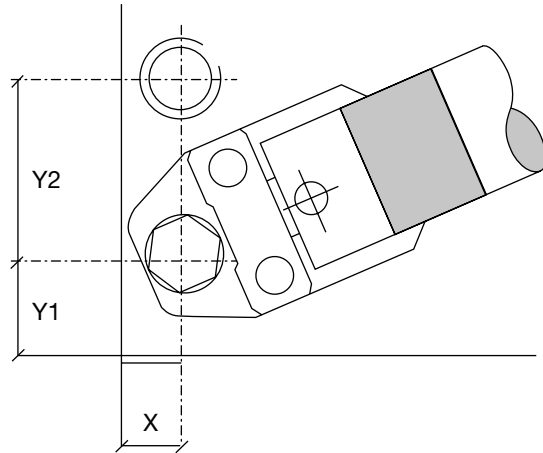
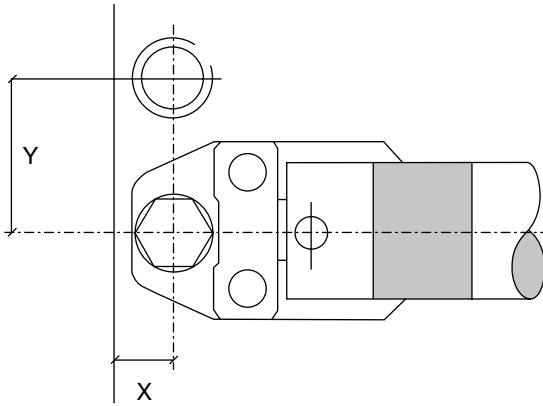

Space Required to Complete a Pressing Between Tubes and Wall ROTHENBERGER ROMAX 400				
Tube Size - OD (Inches)	X		Y	
	Inches	mm	Inches	mm
1/4	1-1/4	30	2-3/8	60
3/8	1-1/4	30	2-3/8	60
1/2	1-1/4	30	2-3/8	60
5/8	1-1/4	30	2-3/8	60
3/4	1-1/4	30	2-3/8	60
7/8	1-3/8	35	2-3/8	60
1-1/8	1-3/8	35	2-3/8	60
1-3/8	1-3/8	35	2-3/8	60

Space Required to Complete a Pressing Between Tubes and Wall Corner ROTHENBERGER ROMAX 400						
Tube Size - OD (Inches)	X		Y1		Y2	
	Inches	mm	Inches	mm	Inches	mm
1/4	2	50	2	50	4	100
3/8	2	50	2	50	4	100
1/2	2	50	2	50	4-3/8	110
5/8	2	50	2	50	4-3/8	110
3/4	2	50	2	50	4-3/8	110
7/8	2-3/8	60	2-3/8	60	4-3/4	120
1-1/8	2-3/8	60	2-3/8	60	4-3/4	120
1-3/8	2-3/8	60	2-3/8	60	4-3/4	120

Space Required to Complete a Pressing Between Tubes and Wall ROTHENBERGER ROMAX TT US				
Tube Size - OD (Inches)	X		Y	
	Inches	mm	Inches	mm
1/4	1-1/4	30	2-3/16	55
3/8	1-1/4	30	2-3/16	55
1/2	1	25	2-3/16	55
5/8	1	25	2-3/16	55
3/4	1	25	2-3/16	55
7/8	1-1/4	30	2-3/16	55
1-1/8	1-3/8	35	2-3/16	55

Space Required to Complete a Pressing Between Tubes and Wall Corner ROTHENBERGER ROMAX TT US						
Tube Size - OD (Inches)	X		Y1		Y2	
	Inches	mm	Inches	mm	Inches	mm
1/4	1-5/8	40	1-5/8	40	4	100
3/8	1-5/8	40	1-5/8	40	4-1/4	105
1/2	1-5/8	40	1-5/8	40	4-1/4	105
5/8	1-5/8	40	1-5/8	40	4-1/4	105
3/4	1-5/8	40	1-5/8	40	4-1/4	105
7/8	2-3/16	55	2-3/16	55	4-3/8	110
1-1/8	2-3/8	60	2-3/8	60	4-9/16	115

ZoomLock MAX

Press-to-Connect Refrigerant Fittings

DESIGN CONSIDERATIONS (Continued)

Insertion Depth and Minimum Distances Between Pressings

Due to the reforming of the tube profile when pressed, it is advised that a minimum distance is allowed between each fitting.

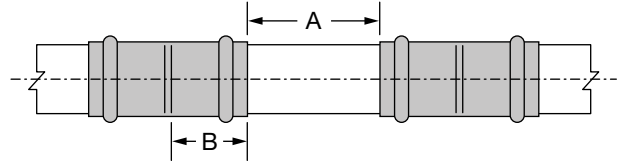

Nominal Size Inches	Minimum Distance A		Insertions Depth B	
	Inches	mm	Inches	mm
1/4	1/2	10	0.71	18.0
3/8	1/2	10	0.71	18.0
1/2	5/8	15	0.75	19.0
5/8	5/8	15	0.87	22.0
3/4	7/8	20	0.91	23.0
7/8	7/8	20	0.98	25.0
1-1/8	1	25	1.04	26.5
1-3/8	1-3/8	35	1.34	34.0

Minimum Distance for Press Fittings from an Existing Brazed Joint

To ensure proper sealing of both the brazed and ZoomLock MAX fitting the following minimum distances must be maintained between the two fittings.

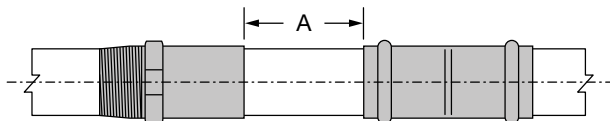

Minimum Distance from a Brazed Joint		
Nominal Size Tube - OD	Minimum Distance A	
Inches	Inches	mm
1/4	1/2	10
3/8	1/2	10
1/2	5/8	15
5/8	5/8	15
3/4	7/8	20
7/8	7/8	20
1-1/8	1	25
1-3/8	1-3/8	35

Note: A - clearance between fitting ends.

It is important that there is no residual brazing or other foreign debris on the tubing to be inserted into the ZoomLock MAX fitting. The surface condition on the area of press joint should be clean and free from debris and comply with ASTM-B280 or ASTM-B88 type ACR, L, or K.

Minimum Brazing Distance to an Existing Pressed Fitting

Caution – Brazing near to ZoomLock MAX joints should be avoided as this may cause the seal to degrade due to heat transfer. The table below states the minimum distance away from the press joint which is acceptable to braze. If this distance cannot be maintained then adequate precautions must be taken such as fabricating the brazed section prior to assembly with the press fittings, wrapping in a wet rag or applying a heat barrier spray, gel or putty, to prevent heat transfer to the press fitting during brazing.

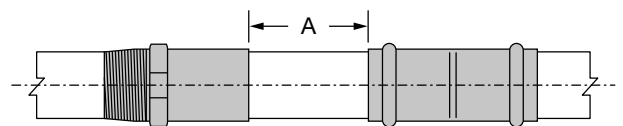

Minimum Distance Brazing		
Nominal Size Tube - OD	Minimum Distance A	
Inches	Inches	mm
1/4	10	250
3/8	12	300
1/2	13-3/4	350
5/8	17-3/4	450
3/4	19-3/4	500
7/8	23-3/4	600
1-1/8	27-1/2	700
1-3/8	35-1/2	900

Note: A - clearance between fitting ends.

ZoomLock MAX

Press-to-Connect Refrigerant Fittings

DESIGN CONSIDERATIONS (Continued)

Testing and Commissioning of Air Conditioning and Refrigeration Systems

Testing and commissioning of air conditioning and refrigeration systems should be in accordance with the requirements specified in:

- ASHRAE 15 - 2016 Safety Standard for Refrigeration Systems.
- ASME B31.5 - 2016 Refrigeration Piping and Heat Transfer Components.
- 2018, 2015, 2012, 2009 and 2006 International Mechanical Code (IMC).
- 2018, 2015, 2012, 2009 and 2006 Uniform Mechanical Code (UMC).

Federal state and local regulations, codes of practice and by-laws governing the installation must also be adhered to.

General

- Dry oxygen free nitrogen (OFN) should be used for tightness and strength testing as it is inert. Do not use oxygen for pressure testing, under pressure it can react violently with hydrocarbons (oil and grease) resulting in explosions and fire.
- The maximum test pressure to be identified by the installer. This will be calculated from the system pressure and the test parameters.
- To ensure ZoomLock MAX fittings are tested safely, during the strength pressure and / or tightness test, the pressure should be raised gradually up to the desired test pressure of the system as established by the installer.

- If you are going to leave the pipework pressurized for 24 hours or longer to check for leaks, measure the system pressure and the ambient temperature at the start and finish of the tightness test. A rise in ambient temperature can mask a leak if this is not taken into account. There will be a pressure change of approximately 10 psi with a temperature change of 9°F.
- Care must be taken to ensure a ZoomLock MAX joint will not be close enough to the liquid charging point that the temperature of the joint drops below -40°F when breaking a vacuum by liquid charging the system.

Problem Solving Vacuum Evacuation

Vacuum evacuation removes air, moisture, and non-condensable gases prior to system charging.

Failure to achieve a vacuum:

- A leak or moisture in the system (see below).
- Vacuum pump not working correctly.
- Vacuum pump does not have sufficient capacity.

Failure to hold a vacuum:

- A leak in the system or the connections to the system – find all leaks and repair them.
 - An ultrasonic leak detector can help pinpoint leaks on a system under vacuum.
- Moisture or refrigerant still in the system – continue evacuation.

No remedial action e.g. cutting out fittings from the system should be taken until a proper fault finding exercise has been completed.

ZoomLock MAX Tube Compatibility

ZoomLock MAX Fitting Size Inches	Tube Size Nominal OD		ASTM B280 - ASTM B88 - ASTM B743										
			Wall Thickness - Inches (mm)										
			0.025" (0.64)	0.030" (0.76)	0.031" (0.81)	0.035" (0.89)	0.040" (1.02)	0.042" (1.07)	0.045" (1.14)	0.049" (1.24)	0.050" (1.27)	0.055" (1.40)	0.065" (1.65)
Inches	mm												
1/4	0.250	6.35	■	●									
3/8	0.375	9.53		● ■	●	● ■							
1/2	0.500	12.70			●	● ■							
5/8	0.625	15.88				●	● ■			● ■			
3/4	0.750	19.05				●		● ■		● ■			
7/8	0.875	22.23							● ■				● ■
1-1/8	1.125	28.58									■		■
1-3/8	1.375	34.93										■	■

● Coil lengths in annealed condition.

■ Straight lengths in hard/half hard condition.

Notes:

Ensure coil tubes are in round condition. Oval tubes should be re-rounded.

Hardness tolerance as per approved standards in the table above.

It is the engineer's responsibility to ensure that the tube selected is compatible with ZoomLock MAX and meets the operating pressure requirements of the system.

ZoomLock MAX

Press-to-Connect Refrigerant Fittings

DESIGN CONSIDERATIONS (Continued)

Elbow Equivalent Lengths

Certain applications are more sensitive to pressure losses from piping and require the use of long radius elbows to help ensure the pressure drop is kept to a minimum.

Specifications for Brazed 90° Elbows and ZoomLock® MAX Press-to-Connect 90° Elbows

Fitting Size (Outside Diameter) Inches	Equivalent Length of Brazed 90° Elbows		Equivalent Length of ZoomLock MAX 90° Elbows	
	Short Radius (R/D = 1)	Long Radius (R/D = 1.5)	Standard	Long Radius
1/4	1.0	0.7	0.7	*
3/8	1.2	0.8	0.8	*
1/2	1.4	0.9	1.2	0.7
5/8	1.6	1.0	1.3	0.8
3/4	1.8	1.2	1.5	1.0
7/8	2.0	1.4	1.7	1.1
1-1/8	2.6	1.7	2.2	1.4
1-3/8	3.3	2.3	2.8	1.8

The equivalent lengths of brazed 90° elbows between 1/2" and 1-3/8" are referenced directly from Table 16 in Chapter 1 of the *2018 ASHRAE Handbook: Refrigeration* [1].

R/D = Bend radius of fitting divided by the outside diameter of the tube that goes into the fitting.

*Standard 1/4" and 3/8" ZoomLock MAX 90° elbows have a R/D \geq 1.5 and meet the requirements of long radius.



[1] American Society of Heating, Refrigerating and Air-Conditioning Engineers. (2018). *2018 ASHRAE Handbook: Refrigeration*. Atlanta, GA: American Society of Heating, Refrigerating and Air Conditioning Engineers.

ZoomLock MAX

Press-to-Connect Refrigerant Fittings

INSTALLATION INSTRUCTIONS

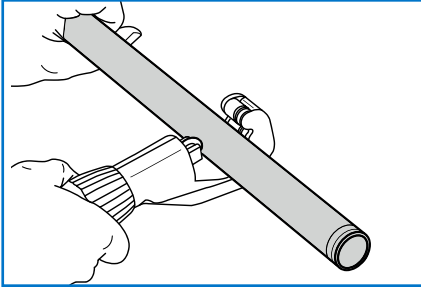

STEP 1

Cut the tube to length

- Use a rotary tube cutter.
- Ensure that the tube is cut square.
- Check the tube has retained its shape and is damage free.

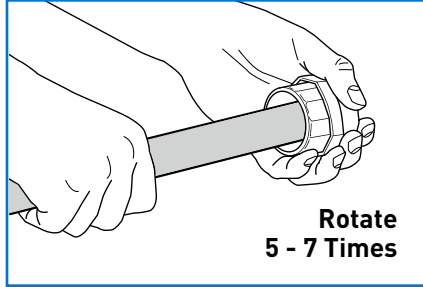

Rotate
5 - 7 Times

STEP 2

Deburr and remove all external sharp edges

- Deburr the tube both internally and externally.
- Where possible angle the tube downwards to prevent filings entering the tube.
- Use a pencil type deburrer on internal tube edges.
- Make sure the internal and external surfaces of the tube ends are smooth and free from burrs or sharp edges.

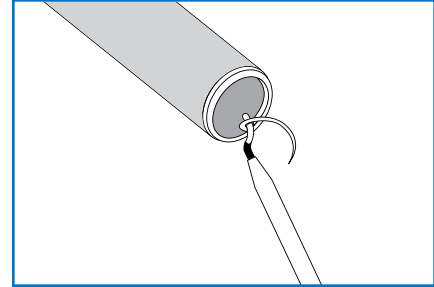

STEP 3

Use a pencil type deburrer on internal edges

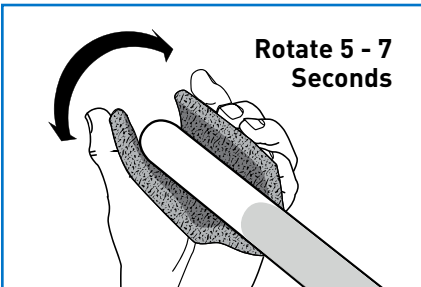

Rotate 5 - 7
Seconds

STEP 4

Clean the tube end

- Thoroughly clean the tube end using a general purpose hand pad or sand cloth in a rotating motion.
- Tube ends must be free from scratches, oxidation, dirt and debris.

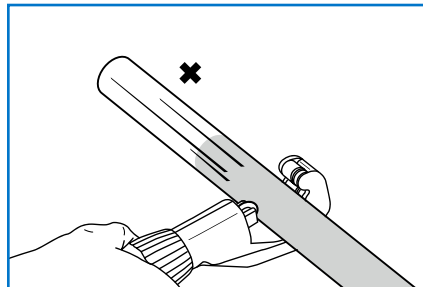

STEP 5

Check for defects

- If deep scratches are still visible, cut the tube back to a clean section and repeat steps 2 - 4.

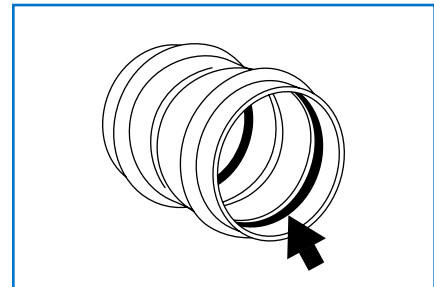

STEP 6

Ensure the O-ring is seated

- Check the fitting is the correct size for the tube.
- Check the O-rings are present and correctly seated.
- A small additional amount of lubricant may be used to aid tube insertion.

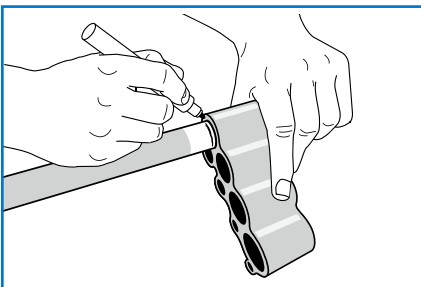

STEP 7A

Mark insertion depth on tube using depth gauge

- Insert tube into correct socket in depth gauge.
- Mark the insertion depth on the tube.

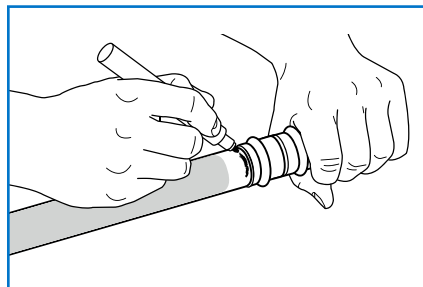

STEP 7B

Alternatively insert tube to tube stop and mark

- The tube must be fully inserted into the fitting until it reaches the tube stop.
- To reduce the risk of dislodging the O-ring rotate the tube (if possible) while slipping it into the fitting.
- Mark the insertion depth on the tube.

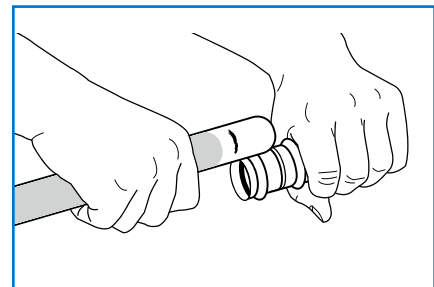

STEP 7B

Check the depth mark

- Remove the tube and align with fitting socket, check that the depth mark is correctly positioned.
- The insertion depth mark is used as a reference prior to pressing the joint.

ZoomLock MAX

Press-to-Connect Refrigerant Fittings

INSTALLATION INSTRUCTIONS (Continued)

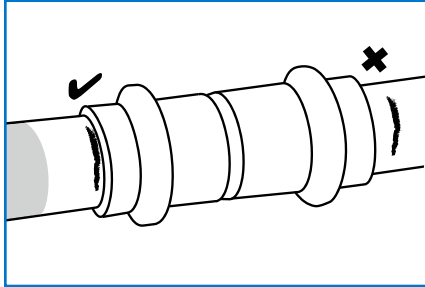

STEP 8

Insert the tube fully into the fitting. Ensure tube is fully inserted prior to pressing

- Insert the tube fully into the fitting up to the tube stop.
- To reduce the risk of dislodging the O-ring rotate the tube (if possible) while slipping it into the fitting.
- Prior to pressing, ensure the tube has not moved out from the fitting socket.
- Use the insertion depth mark as a guide.

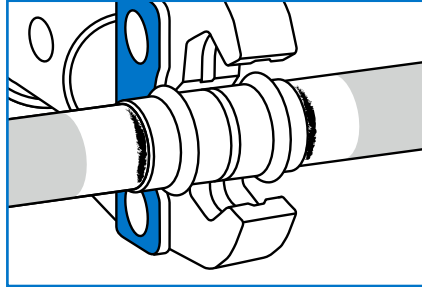

STEP 9

Align jaws squarely on the fitting

- Ensure pipework is correctly aligned prior to pressing.
- Ensure the correct size jaw is inserted into the tool.
- The jaws must be placed squarely on the fitting locating the groove over the o-ring.
- The o-ring on the fitting should fit centrally in the groove of the jaw.

⚠ WARNING: ZoomLock MAX fittings can only be connected with jaws/tools designed for use with ZoomLock MAX products.

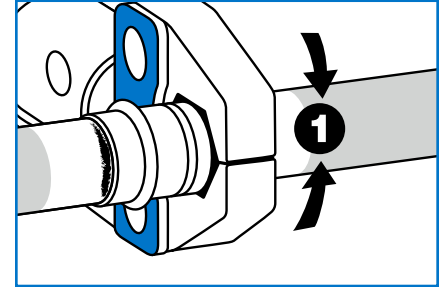

STEP 10

Complete the joint with the approved tool. Press once only

- Depress and hold the button to complete the pressing cycle.
- Pressing is complete when the jaws are fully closed and the piston retracts.
- Complete the press cycle once only – do not repress.
- Release the jaw.

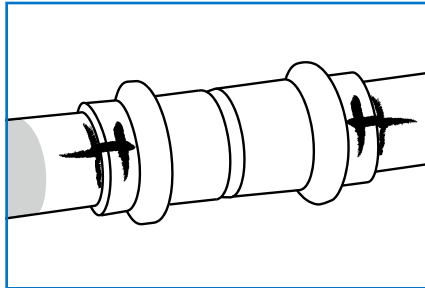

STEP 11

Mark the completed joint

- Mark the completed joint after pressing.
- This enables joints to be inspected easily before testing and insulating the pipework.

ZoomLock MAX

Press-to-Connect Refrigerant Fittings

INSTALLATION INSTRUCTIONS (Continued)

Installing a ZoomLock MAX Female Flare Connector to a Male Flare Connector

Make the flare connection prior to pressing the ZoomLock MAX joint. If this is not possible care must be taken to prevent rotational forces being applied to the pressed joint.

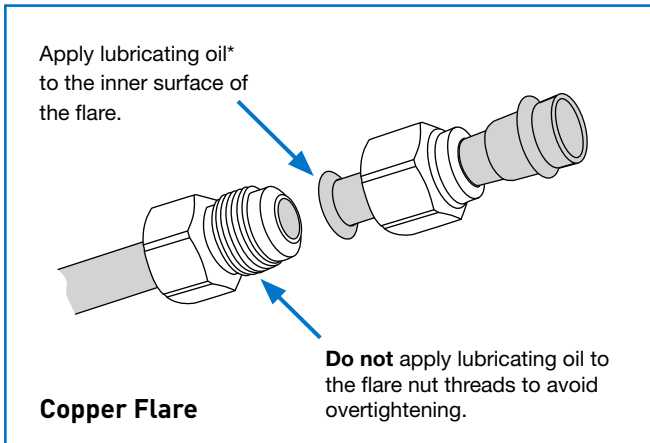

Align the centers of both flares and tighten the flares by hand.

***Note:** A compatible refrigerant lubricant should be used and care should be taken to **avoid application onto flare threads.**

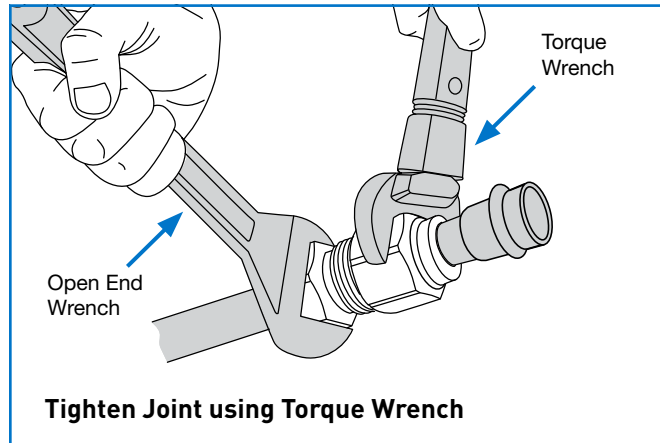

Fully tighten using an open end wrench and torque wrench to the torque values set out in the table. **Do not overtighten.**

Flares Tightening Torque**		
Size	N m	ft lbf
1/4"	14-18	11-13
3/8"	33-42	25-31
1/2"	50-62	37-45
5/8"	63-77	47-56
3/4"	90-110	67-81

****Do NOT overtighten.**

ZoomLock MAX

Press-to-Connect Refrigerant Fittings

FREQUENTLY ASKED QUESTIONS

- Why is it significant that ZoomLock MAX is “UL Listed”?**
UL Listing ensures that ZoomLock MAX meets the industry requirements for field and factory installation.
- How do I ensure I make a secure and leak-free joint?**
Follow all of the steps for prep and installation.
- What is a “deep” scratch, and how do you clean this?**
Your fingernail can feel a deep scratch. Try using a new piece of Scotch-Brite abrasive pad. Alternatively, use a 340 grit sandpaper/cloth.
- Can you show an example of a “good” copper tube surface after sanding?**



Figure 1 - Copper tube with “good” surface.



Figure 2 - Copper tube with “bad” surface scratch.

- How do I know the correct insertion depth when pushing the ZoomLock MAX fitting onto the copper tube?**
Use the depth gauge provided or the minimum insertion depth chart to determine the correct insertion depth. Mark the tubing with a permanent marker to indicate proper insertion depth on every tube.

Table 1

MINIMUM INSERTION DEPTH		
Fitting Size	Inches	Millimeters
1/4	0.71	18.0
3/8	0.71	18.0
1/2	0.75	19.0
5/8	0.87	22.0
3/4	0.91	23.0
7/8	0.98	25.0
1-1/8	1.04	26.5
1-3/8	1.34	34.0

- Do you have a solution for crimping onto swaged or belled tubing like that coming out of the condenser and evaporator on residential units?**

No, we do not have a specific product designed to crimp over the swaged tubing. However, if there are at least 2 inches of straight copper tubing after the flared end and is accessible with the jaws, you may cut the flared end off and crimp directly to the tube.

- Where do I crimp ZoomLock MAX fittings?**
Crimp with the jaw straddling directly over the o-ring section of the fitting.

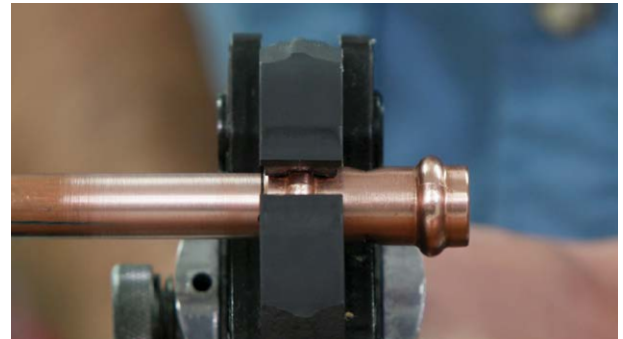

- My jaws sometimes get stuck on the fitting after crimping. What can I do to make it easier to remove the jaws?**
Applying a thin coating of WD-40 or similar lubricant to the jaw before starting a job should help.
- What is the minimum braze distance from the ZoomLock MAX fitting?**

Table 2

MINIMUM DISTANCE FROM ZOOMLOCK MAX FITTING TO BRAZE		
Fitting Size	Inches	Millimeters
1/4	10	250
3/8	12	300
1/2	13.75	350
5/8	17.75	450
3/4	19.75	500
7/8	23.75	600
1-1/8	27.50	700
1-3/8	35.50	900

- What is the minimum distance between ZoomLock MAX fittings?**

Table 3

MINIMUM DISTANCE BETWEEN ZOOMLOCK MAX FITTINGS		
Fitting Size	Inches	Millimeters
1/4	0.50	10
3/8	0.50	10
1/2	0.63	15
5/8	0.63	15
3/4	0.88	20
7/8	0.88	20
1-1/8	1.00	25
1-3/8	1.38	35

ZoomLock MAX

Press-to-Connect Refrigerant Fittings

FREQUENTLY ASKED QUESTIONS (Continued)

- 11. How many crimps can you complete on a complete battery charge?**
Tool dependent; consult the tool manufacturer owner's manual.
- 12. How do you know when to service the tool?**
Tool dependent; consult the tool manufacturer owner's manual.
- 13. What is the expected life of the jaws?**
ZoomLock MAX jaws are laser hardened and have an indefinite life expectancy. We encourage each customer to keep the jaws clean, free of debris, and stored properly when not in use. If any of the wear parts become damaged or non-functional, consult your local ZoomLock MAX distributor.
- 14. What tool manufacturers and models are ZoomLock MAX jaws compatible?**
Refer to page 7 for the press tool compatibility table.
- 15. Where can replacement batteries and chargers be purchased?**
Tool dependent; check the tool manufacturer owner's manual.
- 16. Can you use ZoomLock MAX to crimp to aluminum, steel, or stainless steel?**
No, ZoomLock MAX is designed explicitly for copper to copper connections.
- 17. What standards and codes is ZoomLock MAX compliant with, and what approvals does it hold? See page 6.**
- 18. Does ZoomLock MAX work on both hard and soft copper?**
Yes, ZoomLock MAX is a press fitting system for use with hard, half-hard, or annealed copper tube conforming to EN12735-1 or ASTM-B280.
- 19. What is the warranty on ZoomLock MAX fittings?**
The product has a 10-year warranty from the first date of purchase. Please refer to full terms and conditions.
- 20. What is the material used to make the O-ring?**
Hydrogenated Nitrile Butadiene Rubber (HNBR).
- 21. What is the expected life of the O-ring in the system?**
The expected life of the O-ring, if used within the product specifications for temperature and pressure, is at least 25 years. The product has a 10-year warranty.
- 22. Are there any storage issues, including where the fittings are stored in vehicles and exposed to extremes of high or low temperature?**
No, the product is not subject to degradation under normal storage conditions, provided it's kept in original packaging and not exposed to direct sunlight for long periods.
- 23. What approved refrigerants are for use with ZoomLock MAX?**
See page 6.
- 24. What approved lubricants are for use with ZoomLock MAX?**
See technical data on page 6.
- 25. If ZoomLock MAX leaks on installation, can you braze the fitting rather than cutting out the joint and having to replace the missing tube?**
No, if a pressed fitting is leaking, the fitting must be cut out and replaced. You should not attempt to braze the fitting as you may melt the O-ring material and thus introduce contaminants into the system that could cause other system issues.
- 26. Is there a concern about ice building up and then thawing under the fitting in a horizontal or vertical configuration?**
No, ZoomLock MAX has been thoroughly freeze/thaw tested.
- 27. What is the difference between the press jaws for ZoomLock MAX and press jaws for other HVAC and plumbing press fittings?**
ZoomLock MAX fittings can only be connected with jaws/tools designed for use with ZoomLock MAX products.
- 28. Are there any concerns with corrosion where installations are made in coastal areas or with cleaning agents?**
No, ZoomLock MAX has been Acid Salt Spray tested to ASTM G85. As with all copper installations, avoid exposure to ammonia.
- 29. Does the O-ring compensate for imperfections in the tube to make a tight seal?**
Yes, the O-ring does compensate for small/minor scratches on the surface of the tube. However, avoid imperfections adjacent to the crimp area such as scratches, incise marks, and tubing that is not round. Reference copper piping standard for roundness.
- 30. What happens if the application goes beyond the temperature specifications?**
If you use ZoomLock MAX in an application that the fitting goes beyond the specified limits of the O-ring, then there is an increased likelihood that a leak can occur due to the compromised O-ring.
- 31. How clean are ZoomLock MAX fittings?**
ZoomLock MAX fittings comply with the cleanliness standards as required in the following Copper Tube Standards EN 12735-1 and ASTM-B280. Keep the zip closure bag sealed to protect fittings from contamination.
- 32. How do the fittings cope with vibration from the system?**
Vibration is a recognized cause of leaks, design the system, and install to comply with all local standards and codes of practice, which aim to minimize vibration. Extensively tested ZoomLock MAX fittings ensure the joint doesn't leak as a result of system vibration and complies

ZoomLock MAX

Press-to-Connect Refrigerant Fittings

FREQUENTLY ASKED QUESTIONS (Continued)

with the following standards: ISO 14903, Temperature Pressure Cycling and Vibration Test; UL 109 - 8, Vibration Test; UL 207, Fatigue Shock Test.

33. Will the O-ring be damaged if acid develops in the refrigeration system?

Good installation practice, a nitrogen purge during any brazing (not required with ZoomLock MAX mechanical fittings), a deep evacuation, and the proper installation and use of filter-driers containing new and effective molecular sieve desiccants prevent many system failures including the buildup of acid within the system. When selecting which desiccant material is best for an application, consider water capacity, refrigerant and lubricant compatibility, acid capacity, and physical strength, which are essential characteristics of desiccants.

34. When pressed, small size fittings, mainly elbows, may allow a small amount of rotational movement at the joint. Will this affect the security of the joint?

No, some rotational movement is quite acceptable, the joint won't leak, nor will it come apart under the pressure loading and during system operation. Some joint movement is good and allows for expansion and contraction in the system pipework.

35. Is ZoomLock MAX suitable for medical gas applications?

No, ZoomLock MAX is not suitable for medical gas applications.

36. Can you press a fitting more than once?

No, only press ZoomLock MAX fittings once.

37. Is ZoomLock MAX approved for drinking water systems?

No, don't use ZoomLock MAX for drinking water systems.

38. I need to pull a vacuum, how deep of a vacuum can I pull?

Pull 200 microns for a deep vacuum.

ABBREVIATIONS

AB Oil	Alkyl Benzene oil.
ASHRAE 15 - 2016	Safety Standard for Refrigeration Systems.
ASTM-B280-13	American Standard Specification for Seamless Copper Tube for Air Conditioning and Refrigeration Field Service.
ASTM-B88 Type K or L	Seamless Copper Water Tube.
ASME B31.5 - 2016 - 2016	Refrigeration Piping and Heat Transfer Components.
CFT	Constant Force Technology.
HNBR	Hydrogenated Nitrile Butadiene Rubber.
IMC 2018	International Mechanical Code 2018.
IRC 2018	International Residential Code 2018.
ISO 5149-2:2014	International Standard for Refrigerating systems and heat pumps - Safety and environmental requirements -- Part 2: Design, construction, testing, marking and documentation.
ISO 9001	Certified quality management system.
ISO 14903:2012	International Standard for Refrigerating systems and heat pumps – Qualification of tightness of components and joints.
LED	Light Emitting Diode.
PAO Oil	Poly-alpha-olefin oil.
POE Oil	Polyolester oil.
PVE Oil	Polyvinylether oil.
SMS	Short Message Service.
UL 207	Standard for Refrigerant-Containing Components and Accessories, Nonelectrical.
UL 1963 – 79	Standard for Refrigerant Recovery / Recycling Equipment. Section 79 Tests of Gaskets and Seals Used in Refrigerant Systems.
UL 109 - 7	Standard for Tube Fittings for Flammable and Combustible Fluids, Refrigeration Service, and Marine Use. Section 7 Pull test.
UL 109 - 8	Standard for Tube Fittings for Flammable and Combustible Fluids, Refrigeration Service, and Marine Use. Section 8 Vibration test.
UMC 2015	Universal Mechanical Code 2015.
UNS	Unified Numbering System.

PARKER-HANNIFIN CORPORATION OFFER OF SALE

1. Definitions. As used herein, the following terms have the meanings indicated.

Buyer: means any customer receiving a Quote for Products.

Goods: means any tangible part, system or component to be supplied by Seller.

Products: means the Goods, Services and/or Software as described in a Quote.

Quote: means the offer or proposal made by Seller to Buyer for the supply of Products.

Seller: means Parker-Hannifin Corporation, including all divisions and businesses thereof.

Services: means any services to be provided by Seller.

Software: means any software related to the Goods, whether embedded or separately downloaded.

Terms: means the terms and conditions of this Offer of Sale.

2. Terms. All sales of Products by Seller are expressly conditioned upon, and will be governed by the acceptance of, these Terms. These Terms are incorporated into any Quote provided by Seller to Buyer. Buyer's order for any Products whether communicated to Seller verbally, in writing, by electronic data interface or other electronic commerce, shall constitute acceptance of these Terms. Seller objects to any contrary or additional terms or conditions of Buyer. Reference in Seller's order acknowledgement to Buyer's purchase order or purchase order number shall in no way constitute an acceptance of any of Buyer's terms or conditions of purchase. No modification to these Terms will be binding on Seller unless agreed to in writing and signed by an authorized representative of Seller.

3. Price; Payment. The Products set forth in the Quote are offered for sale at the prices indicated in the Quote. Unless otherwise specifically stated in the Quote, prices are valid for thirty (30) days and do not include any sales, use, or other taxes or duties. Seller reserves the right to modify prices at any time to adjust for any raw material price fluctuations. Unless otherwise specified by Seller, all prices are F.C.A. Seller's facility (INCOTERMS 2020). All sales are contingent upon credit approval and full payment for all purchases is due thirty (30) days from the date of invoice (or such date as may be specified in the Quote). Unpaid invoices beyond the specified payment date incur interest at the rate of 1.5% per month or the maximum allowable rate under applicable law.

4. Shipment; Delivery; Title and Risk of Loss. All delivery dates are approximate, and Seller is not responsible for damages resulting from any delay. Regardless of the manner of shipment, delivery occurs and title and risk of loss or damage pass to Buyer, upon placement of the Products with the carrier at Seller's facility. Unless otherwise agreed prior to shipment and for domestic delivery locations only, Seller will select and arrange, at Buyer's sole expense, the carrier and means of delivery. When Seller selects and arranges the carrier and means of delivery, freight and insurance costs for shipment to the designated delivery location will be prepaid by Seller and added as a separate line item to the invoice. Buyer shall be responsible for any additional shipping charges incurred by Seller due to Buyer's acts or omissions. Buyer shall not return or repackage any Products without the prior written authorization from Seller, and any return shall be at the sole cost and expense of Buyer.

5. Warranty. The warranty for the Products is as follows: (i) Goods are warranted against defects in material or workmanship for a period of ten (10) years from the date of delivery; (ii) Services shall be performed in accordance with generally accepted practices and using the degree of care and skill that is ordinarily exercised and customary in the field to which the Services pertain and are warranted for a period of six (6) months from the date of completion of the Services; and (iii) Software is only warranted to perform in accordance with applicable specifications provided by Seller to Buyer for ninety (90) days from the date of delivery or, when downloaded by a Buyer or end-user, from the date of the initial download. All prices are based upon the exclusive limited warranty stated above, and upon the following disclaimer: **EXEMPTION CLAUSE; DISCLAIMER OF WARRANTY, CONDITIONS, REPRESENTATIONS: THIS WARRANTY IS THE SOLE AND ENTIRE WARRANTY, CONDITION, AND REPRESENTATION, PERTAINING TO PRODUCTS. SELLER DISCLAIMS ALL OTHER WARRANTIES, CONDITIONS, AND REPRESENTATIONS, WHETHER STATUTORY, EXPRESS OR IMPLIED, INCLUDING BUT NOT LIMITED TO THOSE RELATING TO DESIGN, NONINFRINGEMENT, MERCHANTABILITY, AND FITNESS FOR A PARTICULAR PURPOSE. SELLER DOES NOT WARRANT THAT THE SOFTWARE IS ERROR-FREE OR FAULT-TOLERANT, OR THAT BUYER'S USE THEREOF WILL BE SECURE OR UNINTERRUPTED. UNLESS OTHERWISE AUTHORIZED IN WRITING BY SELLER, THE SOFTWARE SHALL NOT BE USED IN CONNECTION WITH HAZARDOUS OR HIGH RISK ACTIVITIES OR ENVIRONMENTS. EXCEPT AS EXPRESSLY STATED HEREIN, ALL PRODUCTS ARE PROVIDED "AS IS".**

6. Claims; Commencement of Actions. Buyer shall promptly inspect all Products upon receipt. No claims for shortages will be allowed unless reported to Seller within ten (10) days of delivery. Buyer shall notify Seller of any alleged breach of warranty within thirty (30) days after the date the non-conformance is or should have been discovered by Buyer. Any claim or action against Seller based upon breach of contract or any other theory, including tort, negligence, or otherwise must be commenced within twelve (12) months from the date of the alleged breach or other alleged event, without regard to the date of discovery.

7. LIMITATION OF LIABILITY. IN THE EVENT OF A BREACH OF WARRANTY, SELLER WILL, AT ITS OPTION, REPAIR OR REPLACE THE NON-CONFORMING PRODUCT, RE-PERFORM THE SERVICES, OR REFUND THE PURCHASE PRICE PAID WITHIN A REASONABLE PERIOD OF TIME. **IN NO EVENT IS SELLER LIABLE FOR ANY SPECIAL, INDIRECT, INCIDENTAL OR CONSEQUENTIAL DAMAGES INCLUDING ANY LOSS OF REVENUE OR PROFITS, WHETHER BASED IN CONTRACT, TORT OR OTHER LEGAL THEORY. IN NO EVENT SHALL SELLER'S LIABILITY UNDER ANY CLAIM MADE BY BUYER EXCEED THE PURCHASE PRICE PAID FOR THE PRODUCTS.**

8. Confidential Information. Buyer acknowledges and agrees that any technical, commercial, or other confidential information of Seller, including, without limitation, pricing, technical drawings or prints and/or part lists, which has been or will be disclosed, delivered or made available, whether directly or indirectly, to Buyer ("Confidential Information"), has been and will be received in confidence and will remain the property of Seller. Buyer further agrees that it will not use Seller's Confidential Information for any purpose other than for the benefit of Seller.

9. Loss to Buyer's Property. Any tools, patterns, materials, equipment or information furnished by Buyer or which are or become Buyer's property ("Buyer's Property"), will be considered obsolete and may be destroyed by Seller after two (2) consecutive years have elapsed without Buyer ordering the Products manufactured using Buyer's Property. Furthermore, Seller shall not be responsible for any loss or damage to Buyer's Property while it is in Seller's possession or control.

10. Special Tooling. "Special Tooling" includes but is not limited to tools, jigs, fixtures and associated manufacturing equipment acquired or necessary to manufacture Goods. Seller may impose a tooling charge for any Special Tooling. Such Special Tooling shall be and remain Seller's property notwithstanding payment of any charges by Buyer. In no event will Buyer acquire any interest in the Special Tooling, even if such Special Tooling has been specially converted or adapted for manufacture of Goods for Buyer and notwithstanding any charges paid by Buyer. Unless otherwise agreed, Seller has the right to alter, discard or otherwise dispose of any Special Tooling or other property owned by Seller in its sole discretion at any time.

11. Security Interest. To secure payment of all sums due from Buyer, Seller retains a security interest in all Products delivered to Buyer and, Buyer's acceptance of these Terms is deemed to be a Security Agreement under the Uniform Commercial Code. Buyer authorizes Seller as its attorney to execute and file on Buyer's behalf all documents Seller deems necessary to perfect Seller's security interest.

12. User Responsibility. Buyer, through its own analysis and testing, is solely responsible for making the final selection of the Products and assuring that all performance, endurance, maintenance, safety and warning requirements of the application of the Products are met. Buyer must analyze all aspects of the application and follow applicable industry standards, specifications, and any technical information provided with the Quote or the Products, such as Seller's instructions, guides and specifications. If Seller provides options of or for Products based upon data or specifications provided by Buyer, Buyer is responsible for determining that such data and specifications are suitable and sufficient for all applications and reasonably foreseeable uses of the Products. In the event Buyer is not the end-user of the Products, Buyer will ensure such end-user complies with this paragraph.

13. Use of Products, Indemnity by Buyer. Buyer shall comply with all instructions, guides and specifications provided by Seller with the Quote or the Products. **Unauthorized Uses.** If Buyer uses or resells the Products in any way prohibited by Seller's instructions, guides or specifications, or Buyer otherwise fails to comply with Seller's instructions, guides and specifications, Buyer acknowledges that any such use, resale, or non-compliance is at Buyer's sole risk. Further, Buyer shall indemnify, defend, and hold Seller harmless from all losses, claims, liabilities, damages, lawsuits, judgments and costs (including attorney fees and defense costs), whether for personal injury, property damage, intellectual property infringement or any other claim, arising out of or in connection with: (a) improper selection, design, specification, application, or any misuse of Products; (b) any act or omission, negligent or otherwise, of Buyer; (c) Seller's use of patterns, tools, equipment, plans, drawings, designs, specifications or other information or things furnished by Buyer;

(d) damage to the Products from an external cause, repair or attempted repair by anyone other than Seller, failure to follow instructions, guides and specifications provided by Seller, use with goods not provided by Seller, or opening, modifying, deconstructing, tampering with or repackaging the Products; or (e) Buyer's failure to comply with these Terms. Seller shall not indemnify Buyer under any circumstance except as otherwise provided in these Terms.

14. Cancellations and Changes. Buyer may not cancel or modify, including but not limited to movement of delivery dates for the Products, any order for any reason except with Seller's written consent and upon terms that will indemnify, defend and hold Seller harmless against all direct, incidental and consequential loss or damage and any additional expense. Seller, at any time, may change features, specifications, designs and availability of Products.

15. Limitation on Assignment. Buyer may not assign its rights or obligations without the prior written consent of Seller.

16. Force Majeure. Seller is not liable for delay or failure to perform any of its obligations by reason of events or circumstances beyond its reasonable control. Such circumstances include without limitation: accidents, labor disputes or stoppages, government acts or orders, acts of nature, pandemics, epidemics, other widespread illness, or public health emergency, delays or failures in delivery from carriers or suppliers, shortages of materials, war (whether declared or not) or the serious threat of same, riots, rebellions, acts of terrorism, fire or any reason whether similar to the foregoing or otherwise. Seller will resume performance as soon as practicable after the event of force majeure has been removed. All delivery dates affected by force majeure shall be tolled for the duration of such force majeure and rescheduled for mutually agreed dates as soon as practicable after the force majeure condition ceases to exist. Force majeure shall not include financial distress, insolvency, bankruptcy, or other similar conditions affecting one of the parties, affiliates and/or sub-contractors.

17. Waiver and Severability. Failure to enforce any provision of these Terms will not invalidate that provision; nor will any such failure prejudice either party's right to enforce that provision in the future. Invalidation of any provision of these Terms shall not invalidate any other provision herein and, the remaining provisions will remain in full force and effect.

18. Termination. Seller may terminate any agreement governed by or arising from these Terms for any reason and at any time by giving Buyer thirty (30) days prior written notice. Seller may immediately terminate, in writing, if Buyer: (a) breaches any provision of these Terms, (b) becomes or is deemed insolvent, (c) appoints or has appointed a trustee, receiver or custodian for all or any part of Buyer's property, (d) files a petition for relief in bankruptcy on its own behalf, or one is filed against Buyer by a third party, (e) makes an assignment for the benefit of creditors; or (f) dissolves its business or liquidates all or a majority of its assets.

19. Ownership of Software. Seller retains ownership of all Software supplied to Buyer hereunder. In no event shall Buyer obtain any greater right in and to the Software than a right in the nature of a license limited to the use thereof and subject to compliance with any other terms provided with the Software.

20. Indemnity for Infringement of Intellectual Property Rights. Seller is not liable for infringement of any patents, trademarks, copyrights, trade dress, trade secrets or similar rights ("Intellectual Property Rights") except as provided in this Section. Seller will defend at its expense and will pay the cost of any settlement or damages awarded in an action brought against Buyer based on a third party claim that one or more of the Products sold hereunder infringes the Intellectual Property Rights of a third party in the country of delivery of the Products by Seller to Buyer. Seller's obligation to defend

and indemnify Buyer is contingent on Buyer notifying Seller within ten (10) days after Buyer becomes aware of any such claim, and Seller having sole control over the defense of the claim including all negotiations for settlement or compromise. If one or more Products sold hereunder is subject to such a claim, Seller may, at its sole expense and option, procure for Buyer the right to continue using the Products, replace or modify the Products so as to render them non-infringing, or offer to accept return of the Products and refund the purchase price less a reasonable allowance for depreciation. Seller has no obligation or liability for any claim of infringement: (i) arising from information provided by Buyer; or (ii) directed to any Products provided hereunder for which the designs are specified in whole or part by Buyer; or (iii) resulting from the modification, combination or use in a system of any Products provided hereunder. The foregoing provisions of this Section constitute Seller's sole and exclusive liability and Buyer's sole and exclusive remedy for claims of infringement of Intellectual Property Rights.

21. Governing Law. These Terms and the sale and delivery of all Products are deemed to have taken place in, and shall be governed and construed in accordance with, the laws of the State of Ohio, as applicable to contracts executed and wholly performed therein and without regard to conflicts of laws principles. Buyer irrevocably agrees and consents to the exclusive jurisdiction and venue of the courts of Cuyahoga County, Ohio with respect to any dispute, controversy or claim arising out of or relating to the sale and delivery of the Products.

22. Entire Agreement. These Terms, along with the terms set forth in the main body of any Quote, forms the entire agreement between the Buyer and Seller and constitutes the final, complete and exclusive expression of the terms of sale and purchase. In the event of a conflict between any term set forth in the main body of a Quote and these Terms, the terms set forth in the main body of the Quote shall prevail. All prior or contemporaneous written or oral agreements or negotiations with respect to the subject matter shall have no effect. These Terms may not be modified unless in writing and signed by an authorized representative of Seller.

23. Compliance with Laws. Buyer agrees to comply with all applicable laws, regulations, and industry and professional standards, including those of the United States of America, and the country or countries in which Buyer may operate, including without limitation the U.S. Foreign Corrupt Practices Act ("FCPA"), the U.S. Anti-Kickback Act ("Anti-Kickback Act"), U.S. and E.U. export control and sanctions laws ("Export Laws"), the U.S. Food Drug and Cosmetic Act ("FDCA"), and the rules and regulations promulgated by the U.S. Food and Drug Administration ("FDA"), each as currently amended. Buyer agrees to indemnify, defend, and hold harmless Seller from the consequences of any violation of such laws, regulations and standards by Buyer, its employees or agents. Buyer acknowledges that it is familiar with all applicable provisions of the FCPA, the Anti-Kickback Act, Export Laws, the FDCA and the FDA and certifies that Buyer will adhere to the requirements thereof and not take any action that would make Seller violate such requirements. Buyer represents and agrees that Buyer will not make any payment or give anything of value, directly or indirectly, to any governmental official, foreign political party or official thereof, candidate for foreign political office, or commercial entity or person, for any improper purpose, including the purpose of influencing such person to purchase Products or otherwise benefit the business of Seller. Buyer further represents and agrees that it will not receive, use, service, transfer or ship any Products from Seller in a manner or for a purpose that violates Export Laws or would cause Seller to be in violation of Export Laws. Buyer agrees to promptly and reliably provide Seller all requested information or documents, including end-user statements and other written assurances, concerning Buyer's ongoing compliance with Export Laws.



Parker Hannifin Corporation
Sporlan Division
206 Lange Drive • Washington, MO 63090 USA
phone 636 239 1111 • fax 636 239 9130
www.zoomlockmax.com