

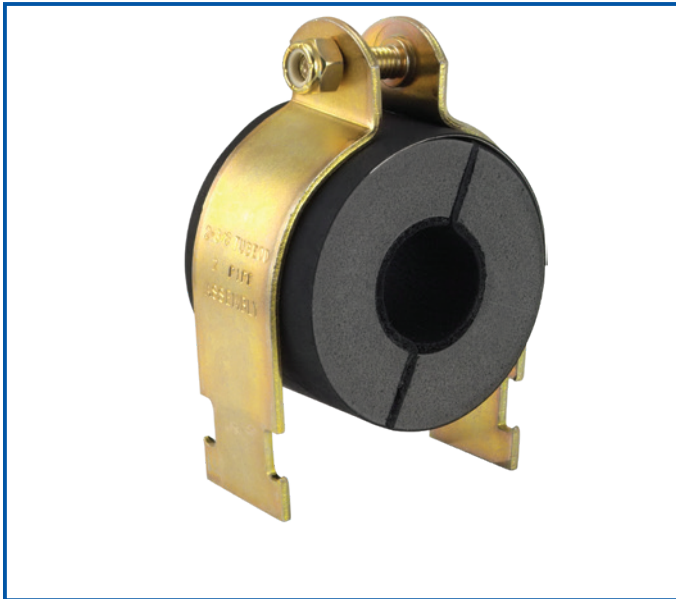

Cush-A-Therm[®]

Vapor Barrier Protection

Airtight Crush-Resistant Insulation Clamp



- No Air Gaps, Hermetically Sealed Tubing
- Prevents Condensation Leaks
- Protects Thermal Barrier
- Absorbs Vibration
- 100% Solid Polyurethane
- Temperature range:
-70°F to +250°F
(-56.7°C to +121°C)

- Properly Supports Pipe and Tube
- Tested in Conformance with ASTM E84 (UL 723, NFPA 255) having results of 0 FSI (Flame Spread Index) and 50 SDI (Smoke Developed Index)
- Rubber Laminate Inside and Out
- Flammability Self-Extinguishing as Tested Under ASTM D 635

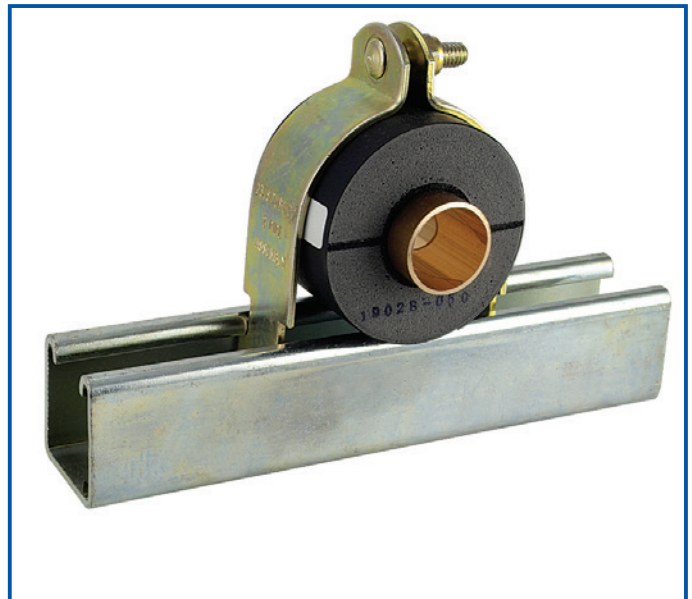

Call ZSi-Foster at (800) 323-7053 or order now at zsi-foster.com

ZSi-Foster

Canton, MI | La Mirada, CA | Murfreesboro, TN | Ocala, FL | Springfield, MO | Totowa, NJ





Cush-A-Therm®

Airtight Crush-Resistant Insulation Clamp

Cush-A-Therm Clamp is a perfect crush-resistant airtight seal for chilled refrigeration or mechanical pipe lines that require continuous insulation.

The rigid foam construction has an insulating tape inner lining which supports tube and absorbs vibration of operating pipe lines.

The outer cover consists of a special rubber coating which seals the cushion after installation in order to prevent condensation.

Its strong closed-cell structure is ideal for liquid cooling lines to prevent condensation, save energy, and maintain the vapor barrier.

NOTE: Complete assembly supplied with Stainless Steel channel clamp and hardware

NOTE: Complete assembly supplied with gold electro-galvanized channel clamp and hardware

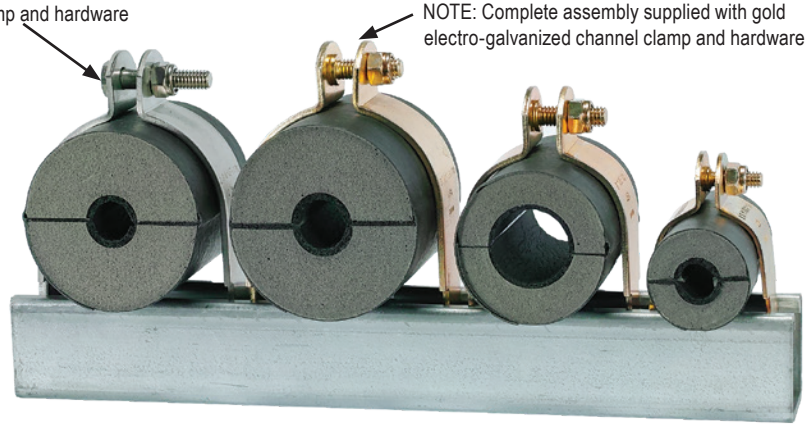

Dimensions (Inches)					Nominal 1/2" (13mm) Wall Thickness				Nominal 3/4" (19mm) Wall Thickness			
Hole Size	Copper I.D.	Pipe O.D.	IPS	Len.	Part No.			Cushion O.D.	Part No.			Cushion O.D.
					Steel	SS 304	SS 316		Steel	SS 304	SS 316	
1/4" (6mm)	-	1/4"	-	2.953" (75mm)	UX1412	UX1412SS	UX1412S6	1 1/4" (1.250") (32mm)	UX1434	UX1434SS	UX1434S6	1 3/4" (1.750") (45mm)
3/8" (10mm)	1/4"	3/8"	-		UX3812	UX3812SS	UX3812S6	1 5/8" (1.375") (35mm)	UX3834	UX3834SS	UX3834S6	1 7/8" (1.875") (48mm)
1/2" (13mm)	3/8"	1/2"	1/4"		UX1212	UX1212SS	UX1212S6	1 1/2" (1.500") (38mm)	UX1234	UX1234SS	UX1234S6	2" (2.000") (51mm)
5/8" (16mm)	1/2"	5/8"	3/8"	2.953" (75mm)	UX5812	UX5812SS	UX5812S6	1 5/8" (1.625") (41mm)	UX5834	UX5834SS	UX5834S6	2 1/8" (2.125") (54mm)
3/4" (19mm)	5/8"	3/4"	-		UX3412	UX3412SS	UX3412S6	1 3/4" (1.750") (45mm)	UX3434	UX3434SS	UX3434S6	2 1/4" (2.250") (57mm)
7/8" (22mm)	3/4"	7/8"	1/2"		UX7812	UX7812SS	UX7812S6	1 7/8" (1.875") (48mm)	UX7834	UX7834SS	UX7834S6	2 3/8" (2.375") (60mm)
1-1/8" (29mm)	1"	1 1/8"	3/4"	2.953" (75mm)	UX11812	UX11812SS	UX11812S6	2 1/8" (2.125") (54mm)	UX11834	UX11834SS	UX11834S6	2 5/8" (2.625") (67mm)
1-3/8" (35mm)	1 1/4"	1 3/8"	1"		UX13812	UX13812SS	UX13812S6	2 3/8" (2.375") (60mm)	UX13834	UX13834SS	UX13834S6	2 7/8" (2.875") (73mm)
1-5/8" (41mm)	1 1/2"	1 5/8"	1 1/4"		UX15812	UX15812SS	UX15812S6	2 5/8" (2.625") (67mm)	UX15834	UX15834SS	UX15834S6	3 1/8" (3.125") (79mm)
1-7/8" (48mm)	-	1 7/8"	-	2.953" (75mm)	UX17812	UX17812SS	UX17812S6	2 7/8" (2.875") (73mm)	UX17834	UX17834SS	UX17834S6	3 3/8" (3.375") (86mm)
2-1/8" (54mm)	2"	2 1/8"	-		UX21812	UX21812SS	UX21812S6	3 1/8" (3.125") (79mm)	UX21834	UX21834SS	UX21834S6	3 5/8" (3.625") (92mm)
2-3/8" (60mm)	2 1/4"	2 3/8"	2"		UX23812	UX23812SS	UX23812S6	3 3/8" (3.375") (86mm)	UX23834	UX23834SS	UX23834S6	3 7/8" (3.875") (98mm)
2-5/8" (67mm)	2 1/2"	2 5/8"	-	3.937" (100mm)	UX25812	UX25812SS	UX25812S6	3 5/8" (3.625") (92mm)	UX25834	UX25834SS	UX25834S6	4 1/8" (4.125") (105mm)
2-7/8" (73mm)	-	2 7/8"	2 1/2"		UX27812	UX27812SS	UX27812S6	3 7/8" (3.875") (98mm)	UX27834	UX27834SS	UX27834S6	4 3/8" (4.375") (111mm)
3-1/8" (79mm)	3"	3 1/8"	-		UX31812	UX31812SS	UX31812S6	4 1/8" (4.125") (105mm)	UX31834	UX31834SS	UX31834S6	4 5/8" (4.625") (118mm)
3-1/2" (89mm)	-	3 1/2"	3"	3.937" (100mm)	UX31212	UX31212SS	UX31212S6	4 1/2" (4.500") (114mm)	UX31234	UX31234SS	UX31234S6	5" (5.000") (127mm)
3-5/8" (92mm)	3 1/2"	3 5/8"	-		UX35812	UX35812SS	UX35812S6	4 5/8" (4.625") (118mm)	UX35834	UX35834SS	UX35834S6	5 1/8" (5.125") (130mm)
4-1/8" (105mm)	4"	4-1/8"	3 1/2"		UX41812	UX41812SS	UX41812S6	5 1/8" (5.125") (130mm)	UX41834	UX41834SS	UX41834S6	5 5/8" (5.625") (143mm)

Airtight Crush-Resistant Insulation Clamp

INSTALLATION IS AS EASY AS 1-2-3!

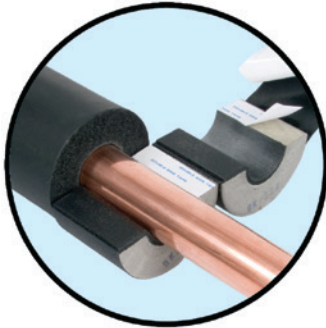

1. Insulation slides over pipes.
Self adhesive surfaces provide seal.

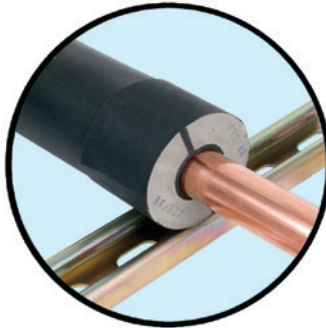

2 Put in place and glue to insulation.

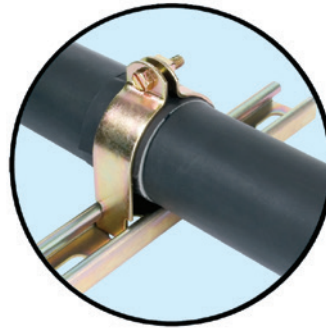

3. Wrap and seal with ProTape.

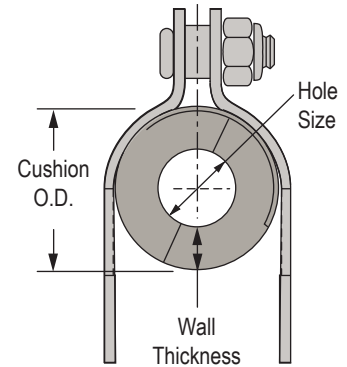

Dimensions	Nominal 1" (25mm) Wall Thickness				Nominal 1-1/2" (38mm) Wall Thickness				Nominal 2" (51mm) Wall Thickness			
	Part No.			Cushion O.D.	Part No.			Cushion O.D.	Part No.			Cushion O.D.
	Steel	SS 304	SS 316		Steel	SS 304	SS 316		Steel	SS 304	SS 316	
1/4" (6mm)	UX1410	UX1410SS	UX1410S6	2 1/4" (2.250") (57mm)	UX1415	UX1415SS	UX1415S6	3 1/4" (3.250") (83mm)	-	-	-	-
3/8" (10mm)	UX3810	UX3810SS	UX3810S6	2 3/8" (2.375") (60mm)	UX3815	UX3815SS	UX3815S6	3 3/8" (3.375") (86mm)	-	-	-	-
1/2" (13mm)	UX1210	UX1210SS	UX1210S6	2 1/2" (2.500") (64mm)	UX1215	UX1215SS	UX1215S6	3 1/2" (3.500") (89mm)	-	-	-	-
5/8" (16mm)	UX5810	UX5810SS	UX5810S6	2 5/8" (2.625") (67mm)	UX5815	UX5815SS	UX5815S6	3 5/8" (3.625") (92mm)	UX5820	UX5820SS	UX5820S6	4 5/8" (4.625") (118mm)
3/4" (19mm)	UX3410	UX3410SS	UX3410S6	2 3/4" (2.750") (70mm)	UX3415	UX3415SS	UX3415S6	3 3/4" (3.750") (95mm)	UX3420	UX3420SS	UX3420S6	4 3/4" (4.750") (121mm)
7/8" (22mm)	UX7810	UX7810SS	UX7810S6	2 7/8" (2.875") (73mm)	UX7815	UX7815SS	UX7815S6	3 7/8" (3.875") (98mm)	UX7820	UX7820SS	UX7820S6	4 7/8" (4.875") (124mm)
1-1/8" (29mm)	UX11810	UX11810SS	UX11810S6	3 1/8" (3.125") (79mm)	UX11815	UX11815SS	UX11815S6	4 1/8" (4.125") (105mm)	UX11820	UX11820SS	UX11820S6	5 1/8" (5.125") (130mm)
1-3/8" (35mm)	UX13810	UX13810SS	UX13810S6	3 3/8" (3.375") (86mm)	UX13815	UX13815SS	UX13815S6	4 3/8" (4.375") (111mm)	UX13820	UX13820SS	UX13820S6	5 3/8" (5.375") (137mm)
1-5/8" (41mm)	UX15810	UX15810SS	UX15810S6	3 5/8" (3.625") (92mm)	UX15815	UX15815SS	UX15815S6	4 5/8" (4.625") (118mm)	UX15820	UX15820SS	UX15820S6	5 5/8" (5.625") (143mm)
1-7/8" (48mm)	UX17810	UX17810SS	UX17810S6	3 7/8" (3.875") (98mm)	UX17815	UX17815SS	UX17815S6	4 7/8" (4.875") (124mm)	UX17820	UX17820SS	UX17820S6	5 7/8" (5.875") (149mm)
2-1/8" (54mm)	UX21810	UX21810SS	UX21810S6	4 1/8" (4.125") (105mm)	UX21815	UX21815SS	UX21815S6	5 1/8" (5.125") (130mm)	UX21820	UX21820SS	UX21820S6	6 1/8" (6.125") (156mm)
2-3/8" (60mm)	UX23810	UX23810SS	UX23810S6	4 3/8" (4.375") (111mm)	UX23815	UX23815SS	UX23815S6	5 3/8" (5.375") (137mm)	UX23820	UX23820SS	UX23820S6	6 3/8" (6.375") (162mm)
2-5/8" (67mm)	UX25810	UX25810SS	UX25810S6	4 5/8" (4.625") (118mm)	UX25815	UX25815SS	UX25815S6	5 5/8" (5.625") (143mm)	UX25820	UX25820SS	UX25820S6	6 5/8" (6.625") (168mm)
2-7/8" (73mm)	UX27810	UX27810SS	UX27810S6	4 7/8" (4.875") (124mm)	UX27815	UX27815SS	UX27815S6	5 7/8" (5.875") (149mm)	UX27820	UX27820SS	UX27820S6	6 7/8" (6.875") (175mm)
3-1/8" (79mm)	UX31810	UX31810SS	UX31810S6	5 1/8" (5.125") (130mm)	UX31815	UX31815SS	UX31815S6	6 1/8" (6.125") (156mm)	UX31820	UX31820SS	UX31820S6	7 1/8" (7.125") (181mm)
3-1/2" (89mm)	UX31210	UX31210SS	UX31210S6	5 1/2" (5.500") (140mm)	UX31215	UX31215SS	UX31215S6	6 1/2" (6.500") (165mm)	UX31220	UX31220SS	UX31220S6	7 1/2" (7.500") (191mm)
3-5/8" (92mm)	UX35810	UX35810SS	UX35810S6	5 5/8" (5.625") (143mm)	UX35815	UX35815SS	UX35815S6	6 5/8" (6.625") (168mm)	UX35820	UX35820SS	UX35820S6	7 5/8" (7.625") (197mm)
4-1/8" (105mm)	UX41810	UX41810SS	UX41810S6	6 1/8" (6.125") (156mm)	UX41815	UX41815SS	UX41815S6	7 1/8" (7.125") (181mm)	UX41820	UX41820SS	UX41820S6	8 1/8" (8.125") (206mm)



Cush-A-Therm[®]

Vapor Barrier Protection

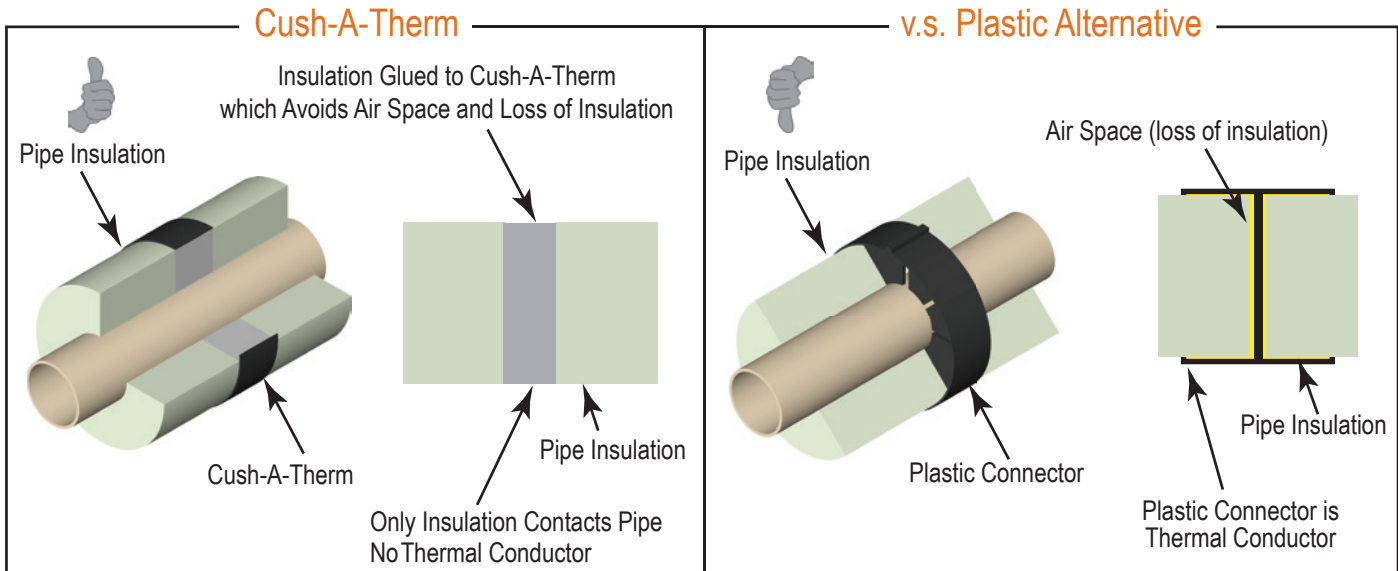

ASHRAE Insulation Recommendations

Cush-A-Therm is designed to meet the ASHRAE recommendations for insulation for mechanical systems which indicate that insulated pipe hangers should provide the following:

1. Complete sealing of pipe against water vapor ingress
2. No energy transfer of cold to supporting clamp to prevent condensation of water and possible growth of mold. If the support encasing the insulation is in contact with the pipe or tube and supported by a metallic clamp, which is not protected by insulation, below ambient temperatures will be transferred to the clamp causing energy transfer and condensation.
3. No interruption of the insulation envelope
4. Limit or avoid compression at support location

ASHRAE Section 23.13-23.14 further states "when the goal is avoiding compression of low-compressive-strength insulation products, it is recommended to use high-strength insulation inserts made of a product that offers the desired compressive strength and other necessary performance properties. Other higher-strength materials that are not thermal insulation material and interrupt the insulation envelope, or do not allow complete sealing of an insulation system against water vapor ingress are not recommended for supporting insulated piping on pipe hangers. Note that wood blocks have poor thermal conductivity and are not recommended, especially for cold pipe systems."

Insulated cold piping should receive special attention when exposed to ambient or unconditioned air. The Cush-A-Therm is a product that seals out air, and insulates the pipe/tube from the supporting clamp, and is therefore in compliance with the 2013 ASHRAE insulation recommendations.



Call ZSi-Foster at (800) 323-7053 or order now at zsi-foster.com

ZSi-Foster

Canton, MI | La Mirada, CA | Murfreesboro, TN | Ocala, FL | Springfield, MO | Totowa, NJ

© Copyright 2020 ZSi-Foster / Printed & Designed in the USA / 05-20 / Therm-3

