

Streamline®

ACR COPPER
PRESS FITTINGS
CATALOG



C
COPPER

PR
PRESS

H
HVAC/R

 **MUELLER
STREAMLINE CO.**





Streamline[®] ACR Copper Press Fittings are the industry’s most innovative and reliable press fittings for refrigerant applications. With dual sealing elements and three points of 360° circular crimping, Streamline[®] ACR Copper Press Fittings are compatible with leading press tools on the market and provide a level of copper joining performance second only to brazing.

- Broad offering of fitting types for today’s HVACR applications
- Available in diameters ranging from ¼” to 1-3/8” OD
- Industry’s only press fitting, featuring DualSeal™ Ring Design
- Packaged in clean, clear, resealable bags
- Offered in convenient pack quantities
- Similar patterns and lay lengths as traditional braze copper fittings
- Compatible with R410A and other commonly used refrigerant gases and oils
- Proprietary jaws readily available from Milwaukee[®] Tool
- Jaws compatible with leading full-size press tools on the market
- 10-Year Limited Warranty

TABLE OF CONTENTS

WHY STREAMLINE [®] ACR PRESS FITTINGS?	4	INSTALLATION INSTRUCTIONS	13
FEATURES & HIGHLIGHTS	5	TESTING AND LEAK DETECTION	14
TOOLS & JAW COMPATIBILITY	7	INSTALLATION GUIDELINES	16
SYSTEM DATA	8	FAQs	20
DIMENSIONAL DATA	9	NOTES	23
APPLICATIONS	12		



WHY STREAMLINE® ACR PRESS?

Along with soldering, brazing, threading, and grooving, press technology has become a standard joining solution for trade professionals. The popularity of press technology in the joining of plumbing, gas, and mechanical copper systems inevitably led to the development of its use with air conditioning and refrigeration applications. Over the recent years, there has been an increased acceptance and use of press technology with refrigerants. However, we were not satisfied that existing press offerings on the market provided sufficient reliability and convenience compared to the established HVAC/R industry-standard brazed connections. During this time, our development team learned a lot about the unique challenges associated with the press joining of refrigerant bearing piping systems. As a result, Streamline® ACR Press Fittings incorporate several thoughtful performance

features to provide not only a more reliable ACR press joint fitting but one that is more familiar and intuitive. These evolutionary advancements have focused on delivering a refrigerant press joining system with greater durability, easier installation, and outstanding leak resistance. We understand that press tools and jaw sets are expensive investments for the contractor and costly inventory items for wholesalers. Therefore, we purposely partnered with a leading American tool company to provide a press jaw solution that works in the same tools used to press copper joints for plumbing and mechanical applications and to press steel joints for gas, mechanical, and fire sprinkler systems. Our efforts succeeded at providing a superior air conditioning and refrigeration copper joining system while also reducing the need for costly reinvestment by the contractor or excessive SKU proliferation for the wholesaler.

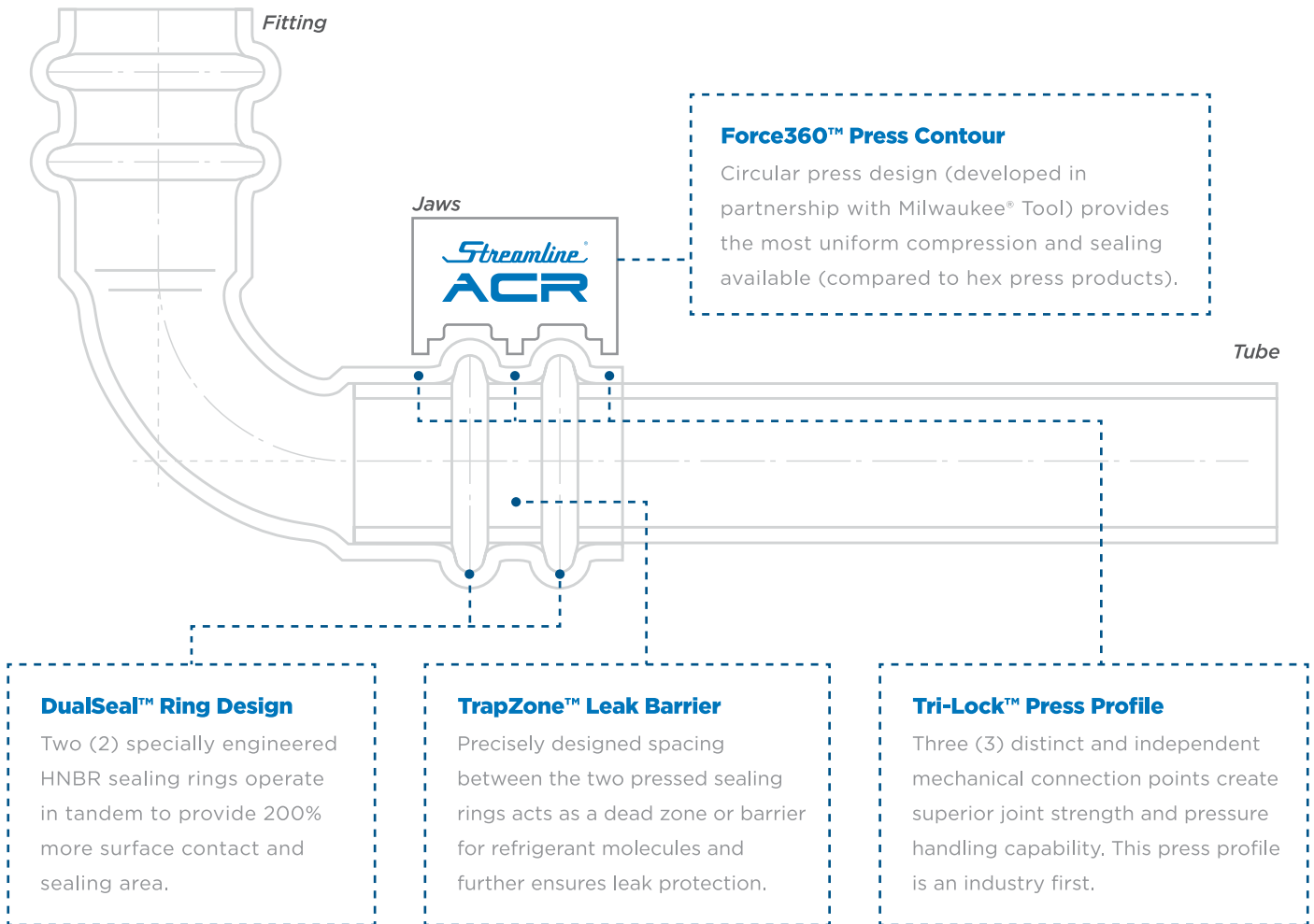

EyeQ™ Intelligent Color Match System

With more and more joining methods and materials in the market, Streamline® wanted to make fittings and joining system selection more simplistic. Our ACR Copper Press Fittings are some of the first to utilize our Eye-Q™ Intelligent Color Match System. Nuances in color across packaging, labeling, literature, seals, and other items will help end users and distributors visually identify the right fitting material, with the right joining method, and for the right system application.





TOOLS & JAW COMPATIBILITY



We are proud to have partnered with Milwaukee[®] Tool in the development of proprietary jaws for use with our dual-seal Streamline[®] ACR Copper Press Fittings. These proprietary jaws are compatible with most common standard full-sized press tools on the market.

It is important to follow the specific manufacturers' guidelines for best use and practice and for required and periodic maintenance of both the tool and jaws used in copper press systems. Failure to do so may void the tool and jaw manufacturers' warranties and cause improper pressing of fittings.

For additional information regarding manufacturers' tools and/or jaw sets, refer to the individual websites of the specific manufacturer. Individual tool and jaw manufacturers' recommended maintenance and calibration schedules vary. Be sure to follow the instructions specific to the brand of tool and jaw set being used.

PART NUMBERS MILWAUKEE [®] STREAMLINE [®] ACR PRESS JAW									
	1/4"	3/8"	1/2"	5/8"	3/4"	7/8"	1-1/8"	1-3/8"	RING JAW
COMPACT JAWS (For Tools Such As M12™)	49-16-2450M	46-16-2452M	49-16-2453M	49-16-2454M	49-16-2455M	49-16-2456M	-	-	-
STANDARD JAWS (For Tools Such As M18™)	49-16-2650M	49-16-2652M	49-16-2653M	49-16-2654M	49-16-2655M	49-16-2656M	*49-16-2657M	*49-16-2658M	*49-16-2659

*Combination of Jaw and Ring Jaw needed for installations 1-1/8"+

COMPACT JAWS FOR 1/4" - 7/8" ONLY

Compatible With:

- Milwaukee M12™ FORCELOGIC™ 2473-20
- REMS Mini-Press A4 22V ACC
- Ridgid RP Series Compact RP 100, RP 200, RP 210, RP 240, RP 241
- DeWalt Compact Press Tool DCE210D2
- Rothenberger Twin Turbo

STANDARD JAWS FOR 1/4" - 1-3/8"

Compatible With:

- Milwaukee[®] M18™ FORCE LOGIC™ 2922-20
- Milwaukee[®] M18™ Long Throw 2773-20L
- Ridgid[®] RP300 series 320-E, RP 330-B, RP 330-C, or RP 340, RP 350
- Dewalt[®] Full Sized DCE200M2
- Hilti Full Sized NPR 32-A Pipe Press Tool
- REMS Full Sized 579011, 579010, 571014, 576011, 576010, 577010, 57211
- Klauke[®] UAP Series
- Rothenberger ROMAX[®] 4000, 3000, & AC ECO Series



Streamline[®] ACR Copper Press Fittings are designed to join ASTM B280 and ASTM B88 (Types ACR, K and L) hard-drawn copper tube from 1/4" to 1-3/8" as well as ASTM B280 and ASTM B1003 soft (annealed) copper tube up to 7/8".

OPERATING PARAMETERS:

- Operating Pressure: 700 PSI / 48 Bar Max
- Operating Temperature: -40°F - 250°F / -40°C - 121°C
- Seal Temperature Rating: -40°F - 300°F / -40°C - 149°C
- Burst Pressure: Minimum 2,100 PSI / 144 Bar
- Vacuum Capability: 200 Microns
- Helium Leak Tightness: 7.5 x 10⁻⁷ Pa.m³/s at +20°C

APPROVALS & CERTIFICATIONS:

- UL 207 • UL 1963 • UL 109
- ISO 14903 • ISO 5149-2
- (IMC) International Mechanical Code
- (IRC) International Residential Code
- (UMC) Uniform Mechanical Code
- ASHRAE 15
- ASME B31.5
- CSA C22.2 No. 140.3-15



APPROVED APPLICATIONS:

- Air Conditioning
- Heat Pump
- VRF and VRV
- Light Commercial Refrigeration
- Non-Potable Water
- Ethylene Glycol
- Technical Gases
 - Nitrogen
 - Oxygen
 - Argon
 - Carbon Dioxide
 - Hydrogen
 - Compressed Air
 - Inert Gases

10-YEAR LIMITED WARRANTY

C
COPPER

PR
PRESS

H
HVAC/R

90° ELBOW

P X P

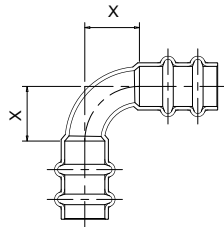

Item No.	Diameter	Catalog Wt.	Inner	Master	Dimensions (in.)	
					X	
RP02715	1/4"	0.04	5	750	0.51	
RP02716	3/8"	0.07	5	450	0.75	
RP02717	1/2"	0.11	5	250	0.75	
RP02722	5/8"	0.17	3	150	0.87	
RP02728	3/4"	0.22	3	120	1.08	
RP02734	7/8"	0.27	3	105	1.08	
RP02747	1-1/8"	0.39	2	60	1.30	
RP02055	1-3/8"	0.54	2	40	1.65	

90° ELBOW • STREET

FTG X P

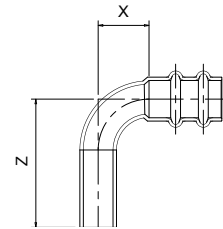

Item No.	Diameter	Catalog Wt.	Inner	Master	Dimensions (in.)	
					X	Z
RP02808	1/4"	0.03	5	750	0.51	1.56
RP02809	3/8"	0.07	5	500	0.75	2.07
RP02817	1/2"	0.10	5	300	0.75	1.93
RP02822	5/8"	0.16	3	150	0.87	2.19
RP02828	3/4"	0.20	3	135	1.08	2.42
RP02834	7/8"	0.26	3	105	1.08	2.52
RP02847	1-1/8"	0.37	2	60	1.30	2.83
RP02350	1-3/8"	0.53	2	40	1.65	3.31

45° ELBOW

P X P

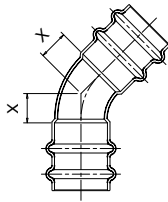

Item No.	Diameter	Catalog Wt.	Inner	Master	Dimensions (in.)	
					X	
RP03005	1/4"	0.04	5	750	0.28	
RP03012	3/8"	0.06	5	450	0.35	
RP03021	1/2"	0.10	5	250	0.37	
RP03026	5/8"	0.16	3	150	0.43	
RP03030	3/4"	0.20	3	120	0.55	
RP03034	7/8"	0.26	3	105	0.55	
RP03044	1-1/8"	0.36	2	60	0.63	
RP03050	1-3/8"	0.48	2	40	0.79	

CAP

P

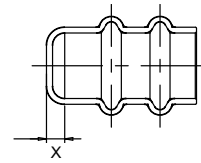

Item No.	Diameter	Catalog Wt.	Inner	Master	Dimensions (in.)	
					X	
RP07002	1/4"	0.02	5	400	0.10	
RP07004	3/8"	0.03	5	400	0.16	
RP07006	1/2"	0.05	5	400	0.18	
RP07007	5/8"	0.07	2	300	0.22	
RP07008	3/4"	0.09	2	200	0.18	
RP07009	7/8"	0.12	2	160	0.18	
RP07011	1-1/8"	0.15	1	90	0.18	
RP07012	1-3/8"	0.21	1	70	0.2	

TEE

P X P

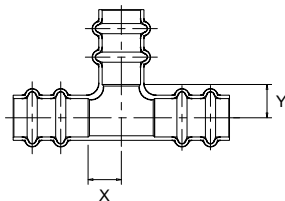

Item No.	Diameter	Catalog Wt.	Inner	Master	Dimensions (in.)	
					X	Y
RP04000	3/8"	0.10	5	250	0.39	0.39
RP04001	1/2"	0.19	5	170	0.47	0.47
RP04006	5/8"	0.27	2	90	0.55	0.55
RP04017	3/4"	0.36	2	80	0.59	0.59
RP04031	7/8"	0.49	2	60	0.67	0.67
RP04048	1-1/8"	0.65	1	40	0.79	0.79
RP04068	1-3/8"	0.85	1	30	0.96	0.96

FLARE

P X FLR SAE

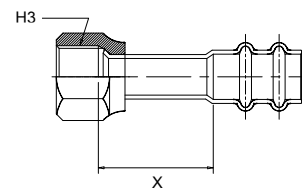

Item No.	Diameter	Catalog Wt.	Inner	Master	Dimensions (in.)	
					X	H3
RP15725	1/4"	0.07	5	500	1.46	7/16"-20 UNF
RP15726	3/8"	0.13	5	300	1.57	5/8"-18 UNF
RP15727	1/2"	0.22	5	180	1.57	3/4"-16 UNF
RP15728	5/8"	0.30	2	130	1.61	7/8"-14 UNF
RP15729	3/4"	0.46	2	80	1.95	1-1/16"-14 UNS

C
COPPER

PR
PRESS

H
HVAC/R

DIMENSIONAL DATA

COUPLING • STAKED STOP

P X P

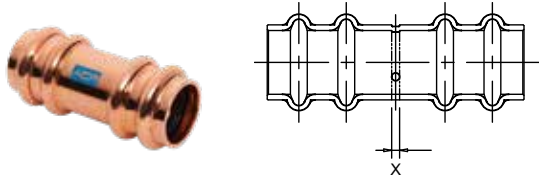

Item No.	Diameter	Catalog Wt.	Inner	Master	Dimensions (in.)
					X
RP10141	1/4"	0.03	5	900	0.08
RP10143	3/8"	0.05	5	600	0.08
RP10144	1/2"	0.09	5	300	0.08
RP10145	5/8"	0.13	5	225	0.08
RP10157	3/4"	0.15	2	150	0.08
RP10146	7/8"	0.19	2	90	0.08
RP10147	1-1/8"	0.27	2	70	0.08
RP10148	1-3/8"	0.36	2	50	0.08

COUPLING • REDUCING

P

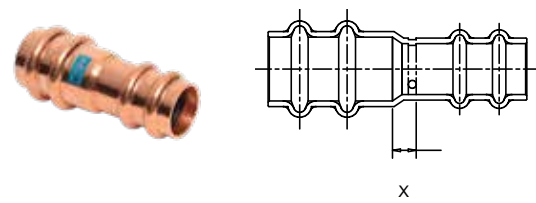

Item No.	Diameter	Catalog Wt.	Inner	Master	Dimensions (in.)
					X
RP01011	3/8" x 1/4"	0.04	5	600	0.24
RP01021	1/2" x 1/4"	0.06	5	500	0.39
RP01019	1/2" x 3/8"	0.07	5	300	0.24
RP01027	5/8" x 1/4"	0.08	2	250	0.51
RP01025	5/8" x 3/8"	0.10	5	250	0.43
RP01023	5/8" x 1/2"	0.12	2	160	0.24
RP01030	3/4" x 1/2"	0.13	2	200	0.35
RP01029	3/4" x 5/8"	0.14	2	150	0.24
RP01037	7/8" x 1/2"	0.16	2	180	0.43
RP01036	7/8" x 5/8"	0.18	2	170	0.28
RP01035	7/8" x 3/4"	0.18	2	110	0.24
RP01052	1-1/8" x 1/2"	0.22	1	90	0.67
RP01050	1-1/8" x 3/4"	0.24	1	90	0.43
RP01051	1-1/8" x 5/8"	0.23	1	90	0.51
RP01049	1-1/8" x 7/8"	0.25	1	60	0.31
RP01056	1-3/8" x 1-1/8"	0.33	1	40	0.33

COUPLING • NO STOP • EXTENDED

P X P

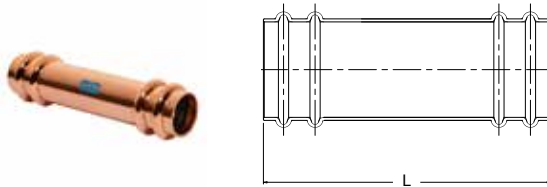

Item No.	Diameter	Catalog Wt.	Inner	Master	Dimensions (in.)
					L
RP01947	1/4"	0.05	5	600	3.94
RP01948	3/8"	0.09	5	300	4.13
RP01949	1/2"	0.15	5	200	4.33
RP01950	5/8"	0.22	5	150	4.53
RP01951	3/4"	0.25	2	100	4.53
RP01952	7/8"	0.31	2	80	4.72
RP01955	1-1/8"	0.42	2	50	5.12
RP01956	1-3/8"	0.58	2	40	5.51



C

COPPER

PR
PRESS

H

HVAC/R

ALSO AVAILABLE

CYCLEMASTER® MULTI SPLIT BALL VALVE, WITH ACCESS PORT
FTG X FTG



Item No.	Diameter	Catalog Wt.	Inner	Master	Dimensions (in.)	
					X	Y
RP18959	1/4"	0.61	1	32	6.51	1.81
RP18960	3/8"	0.62	1	32	6.15	1.63
RP18961	1/2"	0.63	1	32	6.43	1.64
RP18962	5/8"	0.66	1	32	6.25	1.65
RP18963	3/4"	0.93	1	24	6.70	1.94
RP18964	7/8"	0.96	1	24	6.70	1.94
RP17865	1-1/8"	1.65	1	12	8.42	2.87
RP17866	1-3/8"	2.53	1	10	10.20	3.25

CYCLEMASTER® MULTI SPLIT BALL VALVE, WITH ACCESS PORT & INSULATION
FTG X FTG



Item No.	Diameter	Catalog Wt.	Inner	Master	Dimensions (in.)	
					X	Y
RP19101U	1/4"	0.61	1	24	6.51	1.81
RP19102U	3/8"	0.62	1	24	6.15	1.63
RP19103U	1/2"	0.63	1	24	6.43	1.64
RP19104U	5/8"	0.66	1	24	6.25	1.65

DRYMASTER® HEAT PUMP FILTER DRIER
FTG X FTG

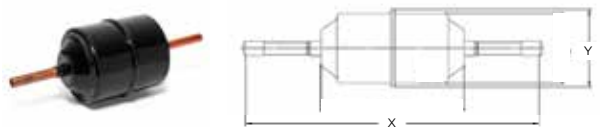

Item No.	Diameter	Catalog Wt.	Inner	Master	Dimensions (in.)	
					X	Y
RP17389	3/8" - 8 in ³	1.26	1	20	8.03	2.63
RP17391	3/8" - 16in ³	2.19	1	16	8.59	3.11

HERMETICALLY SEALED SIGHT GLASS/MOISTURE INDICATOR
FTG X FTG

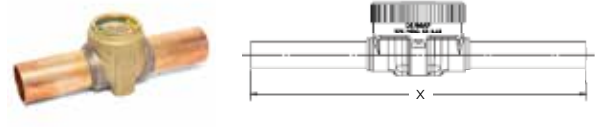

Item No.	Diameter	Catalog Wt.	Inner	Master	Dimensions (in.)
					X
RP18114	1/4"	0.18	1	56	4.85
RP18115	3/8"	0.19	1	56	4.49
RP18116	1/2"	0.25	1	56	4.71
RP18117	5/8"	0.28	1	56	4.95
RP18118	3/4"	0.44	1	48	5.37
RP18119	7/8"	0.47	1	48	5.19
RP18120	1-1/8"	0.53	1	48	6.30

DRYMASTER® LIQUID LINE FILTER DRIER
FTG X FTG

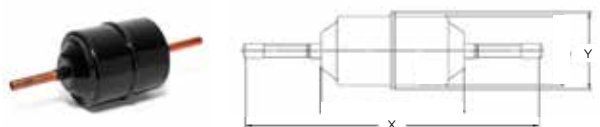

Item No.	Diameter	Catalog Wt.	Inner	Master	Dimensions (in.)	
					X	Y
RP16649	3/8" - 8in ³	0.77	1	25	8.16	2.32
RP16653	3/8" - 16in ³	1.46	1	16	8.51	3.12
RP16654	1/2" - 16 in ³	1.49	1	16	8.51	3.12

CONE TOOL



Item No.	Diameter	Inner	Master
CONE120B	1/4" - 1-3/8"	1	10





APPROVED REFRIGERANTS & OILS

Streamline® ACR Copper Press Fittings are for use in HVAC and VRF applications and are designed to join ASTM B280 and ASTM B88 (Types ACR, K and L) hard-drawn copper tube from 1/4" to 1-3/8" as well as ASTM B280 and ASTM B1003 soft (annealed) copper tube up to 7/8".

APPROVED REFRIGERANTS:

R-125, R-134a, R-32, R-404A, R-407A, R-407C, R-407F, R-407H, R-410A, R-417A, R-421A, R-422B, R-422D, R-427A, R-438A, R-444A, R-447A, R-447B, R-448A, R-449A, R-450A, R-452A, R-452B, R-452C, R-454A, R-454B, R-454C, R-457A, R-459A, R-507A, R-513A, R-513B, R-718, R-1234ze, R-1234yf, R-290, R-600A

APPROVED OILS:

Mineral Oil, POE, PVE, PAO, PAG, and AB

INSTALLATION INSTRUCTIONS

Installer shall be qualified, licensed within the jurisdiction, and familiar with the installation of ACR press systems. The following list of items are needed for the installation of The Streamline® ACR Copper Press Fittings:

- Streamline® ACR Press Fitting
- Full-Sized press tool and Streamline® ACR Press Jaw
- Copper Tube
- Tube cutter or fine tooth saw
- Deburring tool
- Abrasive Pad such as Scotch-Brite™ very fine (maroon)
- Streamline® ACR Press Gauge or ruler / other measuring device
- Permanent Marker



Installation instruction video is available on Mueller Streamline Co.'s YouTube Channel.

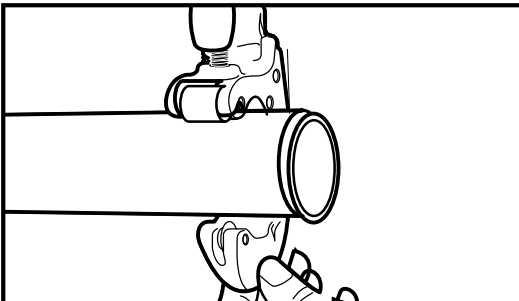

- 1** Cut copper tube square at a 90-degree angle using a tube cutter or a fine tooth saw.
 - Do not use a worn or damaged tube cutter because it can damage the tube and compromise the installation.
 - Care should be taken to avoid cutting the tube in a way that puts incise marks inside the press fitting.
 - When cutting soft (annealed) tubing, do not rush or be too aggressive as this could force the tube out of round.

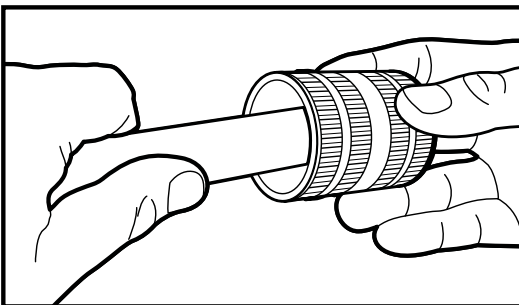

- 2** Deburr tube ID using a pen reamer & OD using a cone tool. Ensure tube ends are free of any burrs or sharp edges.
 - It is critical to visually inspect and feel the end of the tube, as any sharp edges can damage the seals.

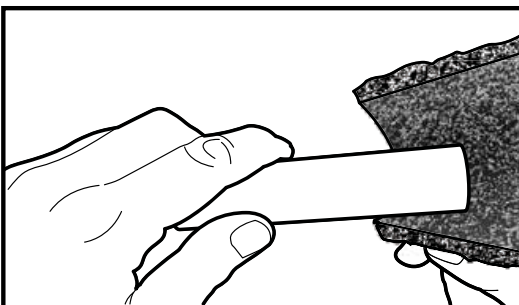

- 3** Clean and smooth end of tube surface using an abrasive pad. Tube surface should be free of indentation, scratches, deformations, oxidation, dirt, and debris.
 - Any imperfections on the ends of the tube where the fitting would cover could inhibit joint integrity.
 - After using abrasive pad, the surface of the tube end should appear bright and shiny, and scratches and other defects will be more easily recognized.
 - If tube is oval or out of round, then re-round with appropriate sizing tool.
 - If any surface or roundness issues can not be corrected, then cut off that portion of tube and restart the process at a new piece of tube.

INSTALLATION INSTRUCTIONS CONTINUED

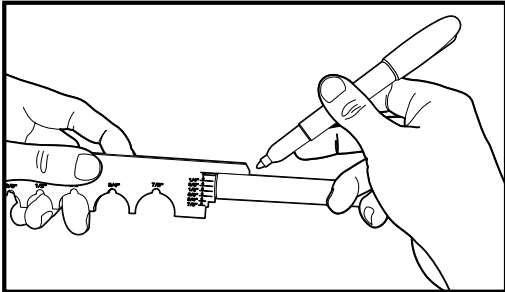

- 4** Mark copper tube to proper fitting insertion depth with the Streamline® ACR Press Gauge or use the insertion depth chart.
- If following the insertion depth chart use a ruler or other measuring device to measure the correct insertion depth, marking with a permanent marker.

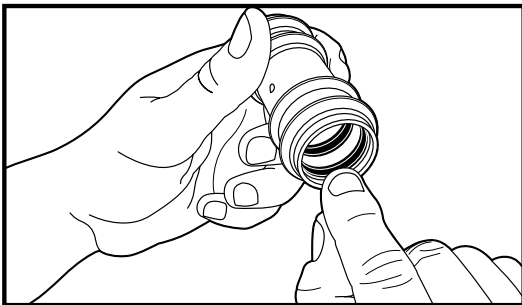

- 5** Check both fitting beads to ensure two seals per cup are present.
- Inspect for obvious damage such as nicks or tears. If the O-ring appears to be damaged, is out of position, or missing- do not use the fitting and use a new one.
 - Fittings should remain in resealable bag until ready to use to avoid any dirt or debris from getting in the system.

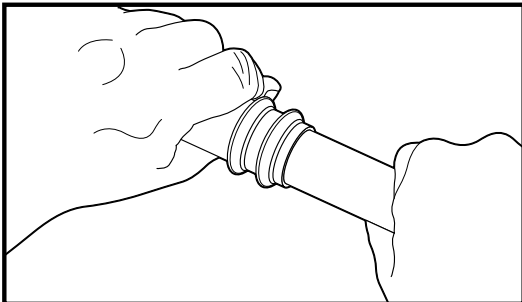

- 6** Slightly rotate the fitting while sliding it onto the tube. Slide all the way to insertion mark & make contact with stop.
- Careful alignment of tube with fitting during insertion is critical to performance of the joint.
 - The insertion mark may go slightly into the fitting or may extend up to 1/4" beyond the end of the cup. If the insertion mark is more than 1/4" beyond the edge of the fitting, then the tube is not fully inserted.
 - If the tube is difficult to insert into the fitting, remove the fitting from the tube to make sure the seals are still seated in the groove. If any seal is dislodged from its groove, then discard the fitting and use a replacement fitting.

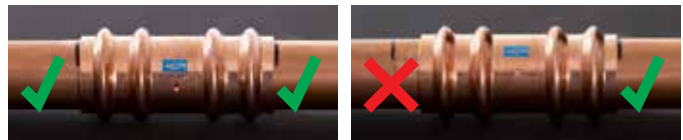

INSTALLATION INSTRUCTIONS CONTINUED

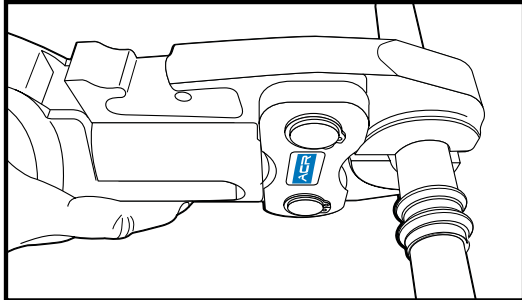

7a Place correct size Streamline® ACR Press Jaw over both beads at a right angle to the tube. Start the pressing process. See tool manufacturer for tool instruction.

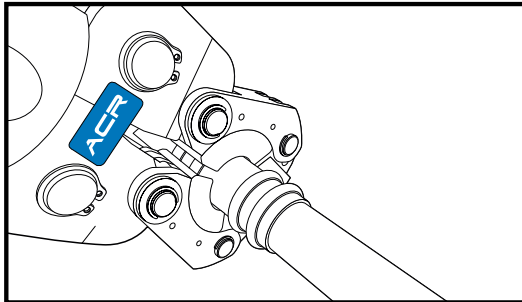

7b For 1-1/8"+, use the Streamline® ACR Press Ring, Ring Jaw, and compatible full-sized press tool. Place Press Ring over both beads at right angle to tube. Use ring jaw to start the pressing process.

- Inspect the jaw at the start of project and periodically during the project for build up or debris.
- The grooves in the jaw will line up over the two seals of the fitting.
- Before pressing, visually inspect that the inserted tube has remained in place and is still at the correct insertion depth as indicated by the depth mark.

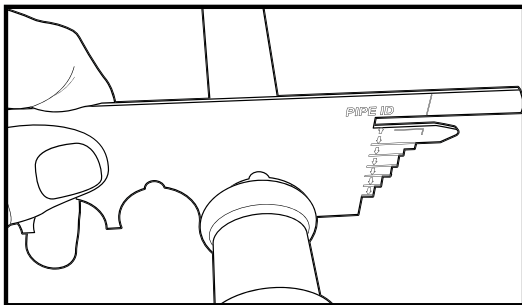

8 Verify connection is secure using the Streamline® ACR Press Gauge between the O-ring beads. Rotate gauge to avoid interference with flashing.

- If the press gauge is unable to fit through the slot on the fitting, it was under-crimped. Attempt to re-crimp to correct joint. If a fitting is still under-crimped, then it must be removed and the procedure restarted.

Streamline® ACR Press Fitting Insertion Depth Chart (1/4" to 1-3/8")

Tube Size (OD)	1/4"	3/8"	1/2"	5/8"	3/4"	7/8"	1-1/8"	1-3/8"
Insertion Depth	1"	1-1/16"	1-3/16"	1-5/16"	1-3/8"	1-7/16"	1-1/2"	1-5/8"

WARNING: Failure to follow all instructions could affect joint/system integrity and may lead to property damage. Call Customer Service at **1-800-FITTING** if you have any questions or need assistance.



Eye and hand protection must be worn.

WARNING: With approved press tool & jaws, such as the Milwaukee® Streamline® ACR Press Jaws. Failure to use correct jaws will affect joint/system integrity & may lead to property damage. Please see specific tool manufacturer for tool instruction.

TESTING AND LEAK DETECTION

After installing Streamline® ACR Press Fittings, the system shall be tested for leaks. This can be done by pressurizing the system with dry nitrogen to a minimum of 50% of the system maximum operating pressure, up to 700 PSI. If holding pressure for extended periods (up to 24 hours), then temperature impacts may need to be taken into account. System leaks can be detected by using a soapy water spray or by utilizing a tracer gas and electronic leak detector.

Any leaks that are identified will need to be cut out and replaced. When replacing a fitting, installers should carefully inspect the surface of that tube before using another fitting to ensure a longitudinal scratch or other surface defect will not result in another leak. It is not allowable to braze the end of a leaking fitting. Always conduct a subsequent pressure test after any repairs are made. Federal, state, and local codes and regulations governing installation and testing must always be followed.

INSTALLATION GUIDELINES

TUBE SELECTION

Streamline® ACR Press Fittings are designed to join ASTM B280 and ASTM B88 hard-drawn copper tube (Types ACR, K, L) from 1/4" to 1-3/8" as well as ASTM B280 soft (annealed) copper tube and ASTM B1003 line set tubing up to 7/8".

Copper tubing made to ASTM standards may contain surface imperfections, which are specifically defined and allowed by the standard. This product is handled and stored multiple times before reaching the actual point of installation, potentially leading to further scratches, nicks or dents. The ASTM standards for copper tubing were designed around joining with solder and braze alloys – both of which are excellent gap-fill materials.

Those who specify and/or install press systems must be aware of the inherent trade-offs that accompany the decision to utilize press technology and O-ring seals. Installers should recognize surface scratches and deep incise marks (identification stamping) on the tube and avoid placing O-ring seals directly over these surface irregularities in order to reduce the risk of leaks. Cleaning the surface with an abrasive pad will help to identify any irregularities and correct minor issues. However, tube with deep scratches may still present a risk of leak and need to be removed.

STORAGE AND HANDLING

Streamline® ACR Press Fittings are packaged in re-sealable polybags to keep them clean and free from dust and debris. Prior to installation, it is highly recommended that a thorough visual inspection of the fittings be performed. Fittings should be handled with care and opened just prior to use, to ensure their cleanliness. The tubing and fittings should be carefully handled during shipment and unloaded with reasonable care. Protect the stored product from moisture and dirt. Elevation above grade and off of concrete is desirable. In the event press fittings are dropped, visually inspect them to assure that fittings have not been damaged or deformed.

TOOLS & JAWS

Streamline® ACR Press Fittings shall be installed using the proper tools, jaws, actuator, and rings as instructed by the respective press fitting and press tool manufacturer.

ELECTRICAL CONTINUITY

Streamline® ACR Press Fittings maintain ground continuity without the need for additional ground continuity straps. The fittings must not be used as a source of electrical ground.

MINIMUM DISTANCES WHEN WORKING WITH STREAMLINE[®] ACR

DISTANCE BETWEEN JOINTS

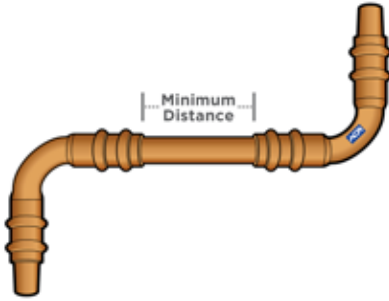

PRESSING NEAR AN EXISTING PRESS CONNECTION

TUBE DIAMETER OD INCH	MINIMUM DISTANCE REQUIRED	
	INCH	MM
1/4"	1/4"	7
3/8"	1/4"	7
1/2"	1/4"	7
5/8"	1/4"	7
3/4"	1/4"	7
7/8"	1/4"	7
1-1/8"	1/4"	7
1-3/8"	1/4"	7

SOLDERING OR BRAZING NEAR AN EXISTING PRESS CONNECTION

Brazing near Streamline[®] ACR Press Fittings should be avoided. The installer should take precautions to keep the press connection cool.

These methods may include:

1. Wrapping the press connection with a cold wet cloth.
2. Fabricating solder connections prior to installing the press fitting.
3. Applying heat barrier spray, gels, or putty to avoid heat transfer to the press fitting.

TUBE DIAMETER OD INCH	SOLDERING	BRAZING	
	MINIMUM DISTANCE INCH	MIN. DISTANCE WET WRAPPED INCH	MIN. DISTANCE UNPROTECTED INCH
1/4"	1-1/2"	5"	10"
3/8"	1-1/2"	5"	10"
1/2"	1-1/2"	5"	10"
5/8"	1-1/2"	6"	12"
3/4"	2-1/4"	7"	14"
7/8"	3"	8"	16"
1-1/8"	4"	11"	22"
1-3/8"	6"	13"	26"

PRESSING NEAR AN EXISTING SOLDERED OR BRAZED CONNECTION

It is important that there is no foreign debris or residual brazing alloy on the tubing to be inserted into the Streamline[®] ACR Press Fitting.

The surface condition on the area of press joint should be clean and free from debris and comply with ASTM B280, ASTM B88, or ASTM B1003. The area of the braze joint shall be cooled down before insertion.

TUBE DIAMETER OD INCH	MINIMUM DISTANCE REQUIRED	
	INCH	MM
1/4"	3"	76.2
3/8"	3"	76.2
1/2"	3"	76.2
5/8"	3"	76.2
3/4"	3"	76.2
7/8"	3"	76.2
1-1/8"	3"	76.2
1-3/8"	3"	76.2

PRESSURE LOSS

Streamline® ACR Press Elbows are designed to provide the same radius and flow that is proven with our solder/braze-type fittings.

PRESSURE LOSS EXPRESSED AS EQUIVALENT LENGTH (IN FEET OF PIPE)		
TYPE	OD INCHES	EQUIVALENT LENGTH (FT)
Elbow	1/4"	.7
Elbow	3/8"	.8
Elbow	1/2"	.9
Elbow	5/8"	1
Elbow	3/4"	1.2
Elbow	7/8"	1.4
Elbow	1-1/8"	1.7
Elbow	1-3/8"	2.1

FLARE ADAPTER TIGHTENING TORQUE

Streamline® ACR Press Flare Adapters utilize a heavy-duty flare nut that is made to comply with SAE standards in the US as well as JIS B 8607 and is suitable for connecting to minisplit and VRV/VRF equipment.

TUBE DIAMETER	FLARE TIGHTENING TORQUE (DO NOT OVERTIGHTEN)	
	TORQUE FT-LBS	TORQUE N-m
1/4"	10-13	14-18
3/8"	25-30	34-42
1/2"	35-44	49-61
5/8"	49-59	68-82
3/4"	67-81	90-110

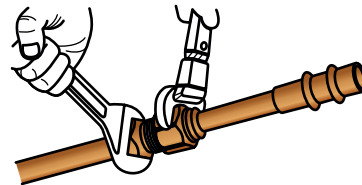

For best results, apply a small amount of refrigerant oil to the flare face during installation and always torque the flare end prior to making the press connection.

PRESSING SPACE LIMITATIONS

Press tool and jaw sets can be difficult to get into some tighter spaces. In these instances, it is recommended that, when possible, to preassemble product away from these space restricted areas. These assemblies can then be installed to minimize the potential for improper alignment of the pressing tools and jaws. For most press joints, use of the press tools and jaws will not pose spatial issues. The following guidelines are recommended for standard installations.

1/4" - 7/8" STANDARD JAW CLEARANCE REQUIREMENT

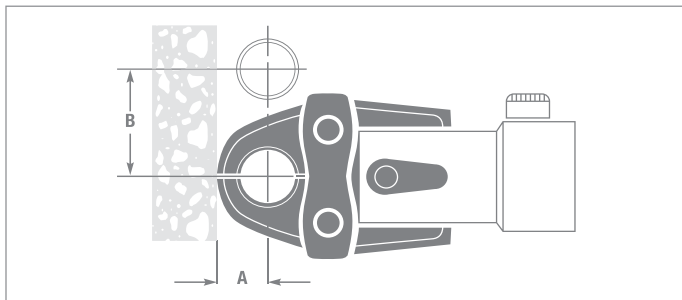

PIPE DIAMETER (INCHES)	A MINIMUM (INCHES)	B MINIMUM (INCHES)
1/4"	5/8"	1-3/4"
3/8"	3/4"	1-3/4"
1/2"	3/4"	2"
5/8"	7/8"	2-1/4"
3/4"	7/8"	2-1/2"
7/8"	1"	2-1/2"

1-1/8"+ PRESSING WITH RING AND ACTUATOR IN TIGHT SPACES

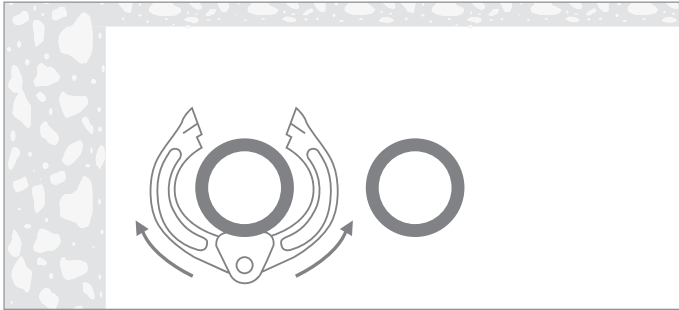

1 Wrap the press ring around the press fitting with the opening facing away from you.

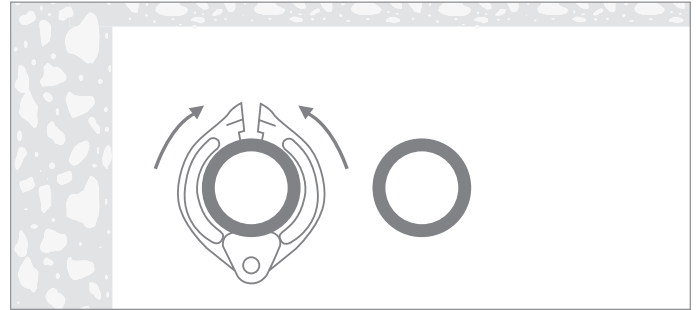

2 Close the press ring tight around the fitting.

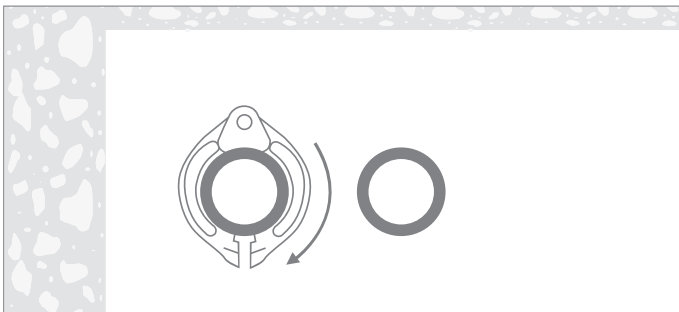

3 Rotate the press ring until the actuator jaw receptacle is facing toward you.

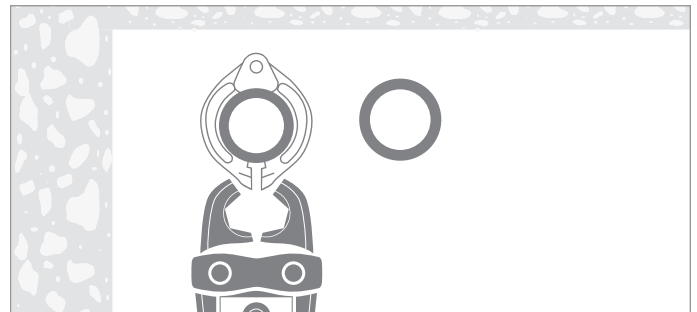

4 Properly insert the actuator jaw and begin the pressing procedure.

MINIMUM SPACE REQUIREMENTS FOR WORKING WITH RING AND ACTUATOR

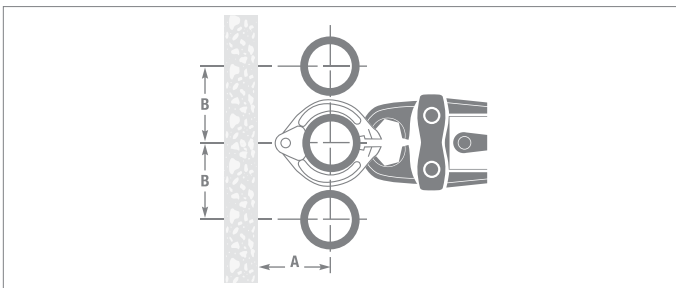

PIPE DIAMETER (INCHES)	A MINIMUM (INCHES)	B MINIMUM (INCHES)
1-1/8"	2-1/2"	3-1/2"
1-3/8"	2-1/2"	3-3/4"

1. What is the operating pressure and temperature for Streamline® ACR Copper Press Fittings?

700 PSI from -40°F to 250°F

2. For what types of applications are Streamline® ACR Copper Press Fittings approved?

- Air Conditioning
- Heat Pump
- VRF and VRV
- Light Commercial Refrigeration
- Non-Potable Water
- Ethylene Glycol

3. What products are included in the Streamline® ACR Copper Press offering?

Fitting sizes 1/4" to 1-3/8" including couplings, elbows, tees, caps, and flare fittings. Also available are Cyclemaster® ball valves.

4. What piping can be used with Streamline® ACR Copper Press Fittings?

Streamline® ACR Copper Press Fittings are designed for use in systems utilizing ASTM B280 and ASTM B88 hard-drawn copper tube (Types ACR, K, L) from 1/4" to 1-3/8" as well as ASTM B280 and ASTM B1003 soft (annealed) copper tube up to 7/8".

5. What is the warranty for Streamline® ACR Copper Press Fittings?

10-year limited warranty for HVAC applications.

6. What testing for long term life was performed on Streamline® ACR Copper Press Fittings?

Each size is validated in our FLOWLAB™ using R410A heat pump systems to conduct accelerated life testing that simulates at least 12 years of life in an HVAC system. The number of cycles is based on AHRI protocols for equipment life and involves rapid transitions between heating and cooling cycles to fully stress system components.

7. Can Streamline® ACR Copper Press Fittings be installed in a system subject to freezing?

Yes — Reference the minimum operating temperature of the fittings.

8. Can Streamline® ACR Copper Press Fittings be installed in tight spaces?

Yes — as long as there is sufficient clearance around each joint to allow for the pressing tool and jaw to crimp without interference.

9. What does HNBR stand for?

Hydrogenated Nitrile Butadiene Rubber.

10. What pressing tools can be used with Streamline® ACR Copper Press Fittings?

Streamline® ACR Press Fittings are compatible with 32 kN full-sized press tools such as Milwaukee® M18™ Force Logic™ Press Tools.

11. What pressing jaws can be used with Streamline® ACR Copper Press Fittings?

Milwaukee® Tool has developed jaws for use specifically with Streamline® ACR Copper Press Fittings. Below are their part numbers for each size jaw. Jaw kits are available with and without a Press Tool.

- 1/4" Milwaukee® Streamline® ACR Press Jaw (49-16-2650M)
- 3/8" Milwaukee® Streamline® ACR Press Jaw (49-16-2652M)
- 1/2" Milwaukee® Streamline® ACR Press Jaw (49-16-2653M)
- 5/8" Milwaukee® Streamline® ACR Press Jaw (49-16-2654M)
- 3/4" Milwaukee® Streamline® ACR Press Jaw (49-16-2655M)
- 7/8" Milwaukee® Streamline® ACR Press Jaw (49-16-2656M)
- 1-1/8" Milwaukee® Streamline® ACR Press Ring (49-16-2657M)
- 1-3/8" Milwaukee® Streamline® ACR Press Ring (49-16-2658M)
- Milwaukee® FORCE LOGIC™ Ring Jaw (also needed for 1-1/8"+) (49-16-2659)

12. What jaws are required to install 1-1/8" and 1-3/8" fittings?

Installation of 1-1/8" and 1-3/8" fittings requires appropriate size Milwaukee® Streamline® ACR Press Ring as well as Milwaukee® FORCE LOGIC™ Ring Jaw.



13. Can a Streamline® ACR Copper Press Fitting be re-crimped?

Yes — only if required. Jaws should be repositioned 90° from original crimp. There is no guarantee this will correct a problem.

14. What should I do if an ACR Press fitting rotates on the tube due to some torque stress or casual impact of a joint?

Rotational movement of the fitting does not indicate an issue that will lead to a leak or separation. Confirm that the tube is inserted all the way to the fitting stop and that the correct jaws for Streamline ACR Press were used. Complete assembly work around the joint in question and position it exactly as intended and then re-press the fitting — ideally with the jaws positioned 90-degrees to the original crimp. Conduct normal pressure test according to the application.

15. What is the most common error made when installing a Streamline® ACR Copper Press Fitting?

The most common error is skipping installation instructions and not adequately prepping the tube. It is very important to use the abrasive pad and deburring tool. Tube edges need to be free of burrs or any sharp edges. Sealing surfaces also need to be free of deep scratches, gouges, or other irregularities that could interfere with the seals. Refrigerant gas systems involve small molecules running at high pressure, therefore following the tube preparation instructions is critical to avoid leaks.

16. Can I cut the pipe with a reciprocating saw or other aggressive cutting tool?

No – all end cuts should be made with wheel type tube cutters.

17. Do I have to lubricate the pipe or the fitting?

No – Streamline® ACR Copper Press Fittings do not typically require lubrication of the pipe or the fitting. If additional seal lubrication is required, silicon or nonpetroleum based lubricants are recommended.

18. What can I put on the seal if there is tightness when inserting the fitting?

Installers must use a cone tool to deburr the outside edge of the tube. Edge burrs are the number one reason for insertion difficulty. If still tight, installers can always lubricate the seals with the refrigerant oil being used in the system (for example: POE).

19. Can Streamline® ACR Copper Press Fittings be installed in a potable water application?

No – Streamline® ACR Copper Press Fittings are not approved for any potable water usage.

20. What should I do if a Streamline® ACR Press Fitting leaks after pressing?

If the fitting was recently crimped (5-10 minutes) prior to pressurization, it is possible the bubbles are a result of trapped air in crimp area that can leak out over time, and is not a fitting leak. This is more likely to occur on smaller fittings. Since the joint is a permanent one, if a fitting is continuing to leak after 20 minutes, remove the affected fitting and replace with a new one. If fitting is to be returned for analysis, please ensure that there is at least 3 inches of tube on each end of the fitting so it can be analyzed and leak cause determined. Without sufficient tubing, fittings often cannot be tested and analyzed.

21. If a Streamline® ACR Press Fitting leaks, can you braze it in instead of cutting it out and having to replace the missing tube?

No – Streamline® ACR Press Fittings should never be brazed. Trying to braze the fitting will melt the O-ring material and thus introduce contaminants into the system that could cause other system issues. If leaking, the fitting needs to be cut out and replaced.

22. How do I identify scratches of concern?

Any scratch that can be felt with your fingernail could be a concern. If you can slide your nail down the scratch, then it is too severe and must be cut off unless it can be sanded out.

23. How to remove a scratch?

To remove scratches, try using a piece of Scotch-Brite™ abrasive pad to prep the surface. If this does not work to create a smooth tube surface, the scratch may need to be cut out and a different part of tube used.

24. How do I know that the tube is inserted all the way?

Use the Streamline® ACR Press Gauge or refer to the “Minimum Insertion Depth” chart available on the polybags and in the submittal for the proper insertion depth. Mark the tube with a permanent marker to indicate proper insertion depth before putting on the Streamline® ACR Copper Press Fitting. The fitting edge should butt up against the mark when inserted fully onto the tube.

25. How do I press onto the flared or swaged tubing that comes out of the condenser and evaporator on residential units?

The fittings cannot be crimped onto cup-sized tubing. However, next to the factory braze if there is at least enough tubing for full insertion or 2 inches of straight tube after the end is removed, and it is accessible with the jaws and the tool at 90° you can cut the end off and crimp directly to the tube.

26. Is it okay if the tool and jaw are not 90° angle to the fitting?

No – for a proper crimp the tool and jaw need to be at a 90° angle to the fitting.

27. Do I have to use Streamline® Copper Tube with Streamline® ACR Copper Press Fittings?

Although suggested to use Streamline® Copper Tube, the fittings have been qualified to any tube that fits into the standards of ASTM B88, ASTM B280 or ASTM B1003.

28. With two seals per cup, do I have to crimp them twice?

No – the jaw profile is designed to encompass both O-rings in the cup to be crimped at the same time.

29. How many press cycles can you complete on a full battery charge?

Consult the tool manufacturer’s manual for battery life.

30. When should the tool be serviced?

Consult the tool manufacturer’s manual for service requirements.

31. Do the engineered sealing elements compensate for imperfections in the piping to make a tight seal?

It depends. The sealing elements do compensate for some scratches on the surface of the tube; however, the tubing needs to be inspected prior to use. Imperfections in and adjacent to the crimp area could inhibit the joint integrity and should be avoided. These imperfections may include surface scratches, incise marks, zippers and out of round tubing. All tube needs to be properly prepped prior to use.

32. The product specifications state that continuous operating temperature up to 250°F / 121°C. Why is the O-ring is rated to 300°F / 149°C?

The system must normally operate below 250°F, but if temperature spikes in the system happen to occur the O-ring can withstand these spikes up to 300°F.

33. Have Streamline[®] ACR Copper Press Fittings been tested to withstand vibration?

Yes — the fittings have been tested in accordance with the vibration test defined in UL 109 Section 8.

34. Can the Streamline[®] ACR Copper Press Fittings be used to connect aluminum, steel or stainless steel?

No — these fittings are designed for copper-to-copper connections only.

35. My jaws sometimes get stuck on the fitting after crimping. What can I do to make it easier to remove the jaws?

Try applying a thin coating of spray lubricant to the jaw before starting a job. It may also help to rotate the jaw slightly after pressing to release it from the fitting.

36. Do I need to keep Streamline[®] ACR Copper Press Fittings in the bag?

Yes — maintaining cleanliness is highly important to reliable connections. Keep bag sealed to protect fittings from contamination.

37. Are Streamline[®] ACR Copper Press Fittings suitable for medical gas applications?

No — they are not approved for medical gas applications.

38. Can Streamline[®] ACR Copper Press Fittings be used in heating and hot water systems?

Yes — the fittings are suitable for use in non-potable chilled and heating water systems.

39. How deep of a vacuum can Streamline[®] ACR Copper Press Fittings support?

Streamline[®] ACR Copper Press Fittings have been qualified in vacuum down to 200 microns and lower. Consult your equipment manufacturer for specific vacuum testing requirements.

40. Why use an abrasive pad over sandpaper?

It is suggested to use an abrasive pad because it provides for a smoother tube surface. Many varieties of sand paper are too aggressive and can create deep scratches in copper tube surfaces. If sand cloth or sandpaper is preferred, then use a 340 grit or higher. Rolls of open mesh abrasive are typically too aggressive.

41. What refrigerants are Streamline[®] ACR Copper Press Fittings not rated for?

Currently, the fittings are not rated for R-22, R-717, R-723, R-744, or R-764. Please check on www.muellerstreamline.com for most up to date list of refrigerants.

42. Can you braze onto a 90° Elbow – Street?

No — this would carry significant risk of melting the seals in the other cup.

Streamline[®] YOUR SYSTEM

Streamline[®] is the preferred and specified brand of industry professionals around the world. Manufactured to the highest quality standards and designed for years of trouble-free service, Streamline's suite of piping systems products provide the confidence that only comes when a solution is designed to work together.

- Nitrogenized[®] ACR Copper Tubing
- Dehydrated Refrigeration Coils
- Line Sets & Mini-Split Line Sets
- XHP Copper-Iron Tubing
- XHP Copper-Iron Braze Fittings
- System Protection Devices
- Copper Press Fittings
- Copper Solder/Braze Fittings
- Carbon Steel Press Fittings
- Refrigerant Brass Push Fittings
- Brass Flare Fittings
- Refrigeration Valves



MUELLER STREAMLINE CO.

150 Schilling Blvd, Suite 201, Collierville, TN 38017 | 1-800-FITTING | www.muellerstreamline.com

© 2024 Mueller Streamline Co.